

Planning and Design Guideline for Cycle Infrastructure





SHAKTI
SUSTAINABLE ENERGY
FOUNDATION

Planning and Design Guideline for Cycle Infrastructure

Cover Photo: Rajendra Ravi, Institute for Democracy & Sustainability.

Acknowledgements

This Planning and Design guideline has been produced as part of the Shakti Sustainable Energy Foundation (SSEF) sponsored project on Non-motorised Transport by the Transportation Research and Injury Prevention Programme at the Indian Institute of Technology, Delhi. The project team at TRIPP, IIT Delhi, has worked closely with researchers from Innovative Transport Solutions (iTrans) Pvt. Ltd. and SGArchitects during the course of this project. We are thankful to all our project partners for detailed discussions on planning and design issues involving non-motorised transport: The Manual for Cycling Inclusive Urban Infrastructure Design in the Indian Subcontinent' (2009) supported by Interface for Cycling Embassy under Bicycle Partnership Program which was funded by Sustainable Urban Mobility in Asia. The second document is Public Transport Accessibility Toolkit (2012) and the third one is the Urban Road Safety Audit (URSA) Toolkit supported by Institute of Urban Transport (IUT) provided the necessary background information for this document. We are thankful to Prof. Madhav Badami, Tom Godefrooij, Prof. Talat Munshi, Rajinder Ravi, Pradeep Sachdeva, Prasanna Desai, Ranjit Gadgil, Parth Shah and Dr. Girish Agrawal for reviewing an earlier version of this document and providing valuable comments. We thank all our colleagues at the Transportation Research and Injury Prevention Programme for cooperation provided during the course of this study. Finally we would like to thank the transport team at Shakti Sustainable Energy Foundation (SSEF) for providing the necessary support required for the completion of this document.

Planning and Design Guideline for Cycle Infrastructure

Project Team

Transportation Research & Injury Prevention Programme (TRIPP), IIT Delhi

Prof. Geetam Tiwari	Project Incharge
Ruchi Varma	Project Associate
Parvesh Sherawat	Project Associate
Anusha Vaid	Project Associate

Innovative Transport Solutions (iTrans) PVT. LTD

Dr. Anvita Arora	MD & CEO
Ravi Gadepalli	Manager (Transportation)

SGArchitects, New Delhi

Sandeep Gandhi	Principal Architect
Satyajit Ganguly	Architect / Transport Planner

Project Support

Mahesh Gaur	Office Administrator
-------------	----------------------

Table of Contents

1	Introduction to Non Motorised Transport.....	7
1.1	Why a Planning and Design Guideline for Cycle Infrastructure?	7
1.2	Current Users and Trends	7
1.3	Trip Length Frequency in Cities.....	8
1.4	Potential Vs. Captive Cyclists	8
1.5	Different Kinds of Cyclists	10
1.6	Cycling and Health	10
1.7	Cycling and Safety.....	10
1.8	Cycle and the Environment.....	12
1.9	Current Indian Policy & Guidelines	12
1.10	Examples from Indian Cities	14
1.11	Myths.....	15
2	Planning for Non-Motorised Transport	16
2.1	Planning Requirements.....	16
2.2	Planning Development Process	22
2.3	Data Collection and Review of Existing Scenario	22
2.3.1	Road Network Inventory.....	22
2.3.2	Travel Behavior Pattern of User Groups.....	22
2.4	Needs Assessment Through Travel Demand Modelling	24
2.4.1	Traffic Analysis Zone (TAZ) Map Creation.....	24
2.4.2	Trip Generation.....	26
2.4.3	Current and Potential Cycle Users and Trip Distribution	28
2.4.4	Trip Distribution.....	28
2.4.5	Traffic Assignment and Calibration	30
2.5	Horizon Year Scenarios Analysis	30
2.6	The Non-Motorized Transport Master Plan (NMT-MP) and Network Plan.....	32
2.6.1	Phasing for NMTMP Implementation	32
2.7	Network Planning in Existing Built-up Areas and New Cities.....	34
3	Design for Non-Motorised Transport	36
3.1	Basic Information.....	36
3.2	Design Requirements.....	38
3.3	Data Collection	40
3.4	Infrastructure Design.....	40
3.4.1	Cross Section Design.....	40
3.4.2	Intersection and Approach design.....	44

3.4.3	Special Conditions	46
3.5	Other Design Details.....	50
3.5.1	Riding Material Selection.....	50
3.5.2	Integrating Traffic Calming Measures	50
3.5.3	Edge Treatments.....	52
3.5.4	Road Furniture and Support Facilities	54
3.5.5	Signage	56
3.5.6	Markings.....	56
3.5.7	Services and Utilities.....	56
3.6	Parking Facilities	60
3.7	Annexure	64
3.7.1	Comparison between bicycle and cycle rickshaw.....	64
3.7.2	Total Station Survey – Checklist	64
3.7.3	Activity Survey – Checklist	65
3.7.4	Traffic Volume and Pedestrian Survey	65
3.7.5	Parking Survey	67
3.7.6	Provision of Free Segregated Left turns.....	67
3.7.7	Traffic Calming – Raised Crossing/Table Top.....	69
3.7.8	Material Selection – Criteria	70
4	Implementation.....	72
4.1	Costing.....	72
4.2	Contracting	76
4.3	Safety during Construction and Maintenance	78
4.3.1	During Construction.....	78
4.3.2	Safety during Maintenance.....	84
4.4	Site Supervision	84
4.5	Audit & Benchmarking.....	86
4.5.1	Auditing	86
4.5.2	Benchmarking.....	88
4.5.3	Auditing Tool – CyLOS.....	90
4.6	Annexure	92
4.6.1	Measures for Vulnerable Road Users (VRUs) - SP:55, 2013	92
4.6.2	City Level Survey Formats.....	94
4.6.3	City Wide Cycle Infrastructure Assessment	95
4.6.4	Cycle Audit Sheet at Corridor	97
4.6.5	Cycle Accessibility at Transit Facility	105
4.6.6	List of indicators for NMT derived from LCMP Toolkit (UNEP, 2012)	112

5	Glossary	115
6	Bibliography.....	118

List of Tables

Table 1 :	Size Classification of various study cities (Tiwari & Jain, 2008)	9
Table 2 :	IRC Codes pertaining to design of urban roads and cycle infrastructure	13
Table 3 :	Data required for model development (UNEP, 2012).....	23
Table 4 :	Data derived from the infrastructure inventory surveys for cycle users (UNEP, 2012)	25
Table 5 :	Travel Behavior Data (to be collected as a part of Household surveys) (UNEP, 2012)	25
Table 6 :	MSS and LSS Scenarios (TRIPP, 2011)	29
Table 7 :	Parameters and their weightages to compute Bicycle compatibility index (BCI)	29
Table 8 :	Example Mode-Wise Average Occupancy *	29
Table 9 :	Combination Criteria	35
Table 10 :	Roads, re-categorized	35
Table 11 :	Vehicle Dimensions	37
Table 12 :	Inclines and slopes	38
Table 13 :	Road Typology.....	41
Table 14 :	Cross Section Design Elements.....	41
Table 15 :	Intersection type vs. Severity.....	44
Table 16 :	Advantages and Disadvantages of each approach of crossing bicyclists.....	44
Table 17 :	Intersection Solutions.....	45
Table 18 :	Irregularities on surface.....	51
Table 19 :	Comparison of material selection	51
Table 20 :	Cumulative percentage of mobility impaired people observed to be unable to move more than the stated distance in city centres without rest (County, 2005)	53
Table 21 :	Generic Determinants for a designed space for street vendors.	55
Table 22 :	Depth of laying various Services (MoUD, 2012).....	61
Table 23 :	Effect of Services on Cycle Infrastructure and Movement.....	61
Table 24 :	Elements of cycle parking	62
Table 25 :	Sample cost calculation for segregated cycle track.....	73
Table 26 :	Sample cost calculation for footpath.....	73
Table 27 :	Sample costing for provision of functional lighting.....	73
Table 28 :	Sample costing for Storm water drainage	73
Table 29 :	Sample costing for Electrical & Telephone services	73
Table 30 :	Sample costing for new carriageway	75
Table 31 :	Sample costing for laying telecom conduits	75
Table 32 :	Sample costing for Service Road	75
Table 33 :	Sample costing for secondary footpath.....	77
Table 34 :	Sample costing for provision of Sign Boards & Markings.....	77
Table 35 :	Sample costing for Landscaping & Miscellaneous provisions.....	77
Table 36 :	Sample costing for overall development of NMV infrastructure compared to cycling facility.....	77
Table 37 :	Step by Step procedure adapted for working drawings at site.....	85
Table 38 :	Broad Categories of Zones (UNEP, 2012)	87
Table 39 :	Survey required for NMT facility.	88
Table 40 :	Access area to the public transport stop for different types of road users ((MoUD), 2012)	89
Table 41 :	Indicator for NMT facilities (MoUD, 2012).....	89

List of Figures

Figure 1 : Modal share	9
Figure 2 : Trends in cycle modal share	9
Figure 3: Trip length frequency distribution for Delhi, Pune, Mumbai and Hyderabad	9
Figure 4 : Various NMT users across India (Source PSDA, SGArchitects, Rajinder Ravi, IDS, Anvita Arora) .	11
Figure 5 : Road Traffic fatalities by road user type in six selected cities.....	11
Figure 6 : Examples from various cities in India	14
Figure 7 : Myths.....	15
Figure 8 : The outline of the planning process	17
Figure 9 : Left Figure shows 3 km buffer around education institutes and Right Figure shows catchment area of 5km around govt offices, industrial areas.....	19
Figure 10 : Left figure Shows location of the transport interchanges: Bus Depots, ISBT, transport centers, railway and metro stations and Right figure Shows locations of major Commercial Centres, District Centres, Shops / Mixed Land Use and Wholesale areas.	19
Figure 11 : Motorized Network Coverage of Visakhapatnam City	21
Figure 12 : Non-motorized Network coverage in the City	21
Figure 13 : TAZ map showing the 97 zones	27
Figure 14 : Steps carried out for Horizon year scenario analysis	31
Figure 15 : Steps involved in making of NMT master Plan	33
Figure 16 : Basic Information - Bicycle.....	37
Figure 17 : Basic Information - Rickshaw	37
Figure 18 : Tricycle for the differently-abled.....	37
Figure19 : Clearances and widths.....	39
Figure20 : Per cycle lane widening required at bends based on riding speed and turning radius.....	39
Figure 21 : Activity Survey done on geometric survey at site and then transferred on a digital base. Source: TRIPP, IIT Delhi	41
Figure 22 : Cross Section Design – Prototype for various roads.....	43
Figure 23 : Crossing Methods at Intersection	45
Figure 24 : Grade Separated Crossing for NMV (ongoing construction), Chandigarh	45
Figure 25 : Special Conditions: Bus Shelter, Hawker Spaces, Limitations between 40-200 m	47
Figure 26 : Special Conditions: Limitations upto 40m,Cycle Rickshaw Parking,TSR Parking	49
Figure 27 : Traffic Calming measures: Humps, Chicanes, Rumble Strips	51
Figure 28 : Trapezoidal hump	51
Figure 29 : Traffic Calming measure - Table Top Crossing at Bus Rapid Transit System, Delhi	53
Figure 30 : Edge Treatment : Deterrent Strip, Bollards , Curb laying at Rajkot BRT,Green & Utility Belt, Delhi BRT	53
Figure 31 : Integrated use of bollards and support facilities	55
Figure 32 : Cycle Specific Road Marking	55
Figure 33 : Roads Signs specific to cyclists.	57
Figure 34 : Area of Application - Signages	58
Figure 35 : Area of Application – Marking	59
Figure 36 : Drainage for arterial streets	61

Figure 37 : Bicycle parking.	63
Figure 38 : Traffic Management Process for Construction Zones	79
Figure 39 : Elements of Traffic Control Zone	81
Figure 40 : Signs used in WTMP, Marshals on work site	83
Figure 41 : Use of channelizing devices during construction.	83
Figure 42 : Cyclists move with other traffic in the traffic control zone during construction.....	85
Figure 43 : Road audit methodology adopted by Urban Road Safety Audit	87
Figure 44 : SLB for NMT facilities	89
Figure 45 : Weightages for design principle - Coherence	90
Figure 46 : Weightages for design principle – Safety.....	90
Figure 47 : Weightages for design principle – Directness	91
Figure 48 : Weightages for design principle – Comfort.....	91
Figure 49 : Weightages for design principle - Attractiveness	91

1 Introduction to Non Motorised Transport

Urban Transport is a means of access and not mobility. At present, most of the urban residents in India depend upon non motorised transport (NMT), which includes walking, cycling and cycle rickshaws to meet their access needs. This is because many of them cannot afford other modes of transport. These users are dependent on walking and cycling (Tiwari, 2002). This is why a large amount of utility cycling is present in Indian cities because the cycle is the most affordable form of transport available to low-income households. Non Motorised Transport (NMT) can offer increased mobility to large parts of the population, safeguard the accessibility of otherwise congested cities and provide freedom of movement to rich and poor, young and old. NMT not only offers environmental advantages but provides a holistic range of benefits to both the individual and the city. This includes health, equity, better air quality, poverty alleviation, road safety, liveable cities and equal opportunities to all irrespective of their socio-economic background.

However, there has been a decline in the use of NMT as a result of rising income levels and hostile conditions on roads resulting in a greater dependency on privately owned motorised transport. This not only increases the volumes of traffic on our roads leading to congestion and pollution but also increases our vulnerability to various health issues. City authorities have failed to provide safer streets to NMT users. This is a result of a lack of concern for those who walk and cycle in many Indian cities. The absence of safe infrastructure and high cycle fatalities also deter potential NMT users.

1.1 Why a Planning and Design Guideline for Cycle Infrastructure?

The National Urban Transport Policy (NUTP) and National Mission on Sustainable Habitat (NMSH) have stressed the need for an approach that focuses on people and not vehicles. Road design must not increase dependence on and usage of personal vehicles. This is possible only if cities are built to prioritise public transport, walking and cycling and clean (NMSH, 2011). Indian cities have a high latent demand for cycle and walking trips, which can be realised with the introduction of suitable infrastructure, facilities and resources. Also, our cities, and urban roads today have to be adapted to the concept of universal design in all its totality. NMT also includes tri-wheeled pedal rickshaws used for passenger and goods as well as four wheeled trolley used by street vendors and hawkers. The passenger and goods cycle rickshaws (together with cycles referred to as Non Motorized Vehicles or NMVs), form the primary source of mobility and livelihood to a considerable proportion of the population.

This guideline attempts at improving the overall cycling and NMV environment by providing information covering planning, design, implementation and management of cycle friendly infrastructure based on the context and limitations of Indian cities. The lack of key information on NMT to city authorities as well as designers and practitioners is a missing link to create the necessary infrastructure for NMT in India. The planning and design guideline can assist as a tool for engineers and designers to help them think and execute decisions on the basis of an analytical and detailed design process, relying on sound data and known best practices. It also intends to help condition the decision-making process and design judgment so that the users' requirements from the infrastructure are fulfilled without compromises.

1.2 Current Users and Trends

NMT dominates the modal share of Indian cities. Its high ownership, low cost and easy use make it a desirable mode of transport for students and low income citizens. Even in megacities (population > 8 million), the modal share of NMT ranges between 40% – 50%. This is attributed to the shorter trip lengths in Indian cities and the availability of NMT as the only available mode of transport for low income households. Amongst the informal sector workers, the location of the work place and the residence are the biggest determinants of the ridership; almost all the people whose work involved distribution activities (eg painters, plumbers, electricians, gardeners, couriers, postmen, milkmen, newspapermen, etc.) use bicycles; above 80% of factory / shop workers and 73% of office workers use bicycles. (TRIPP, 2006)

According to a study conducted in 19 cities in India of various factors like population, low income, informal populations, area of the city, per capita trip rate, total vehicular and non-motorized trips, modal shares, bicycle related crashes, number of short trips and average trip lengths (Tiwari & Jain, 2008) , it was observed that cycle was an important commuting mode for poor urban workers and students in Indian cities. Table 1 indicates the size and classification of various Indian cities. Figure 1 indicates the modal share analysis of the study. Thirteen to twenty one percent of bicycle modal share exists only in medium and large cities. Together walking and cycling constitute 40 – 60% of the modal share across these cities. Also, the absolute numbers of cyclists rises to a million which accounts for about 6-8% of their modal share in mega cities.

As mentioned in the revised bicycle master plan of Delhi, (Tiwari & Jain, 2008), a well functioning bicycle infrastructure is the key to a longer lasting safe road-traffic system. Bicycle network which is to be developed in the city must fulfill the following objectives:

- Traffic flow of all vehicles using that corridor should improve.
- Number of accidents involving bicyclists should reduce.
- Potential bicyclists should be encouraged to use bicycles.

Existing NMT and public transport infrastructure in Indian cities is in a dilapidated condition and modal shares for both the modes of transport have been declining consistently (Tiwari & Jain, 2008) (GHATE & SUNDAR, 2010). The time trend analysis in various cities shows a sharp decline in cycle trip share during the last three decades (Figure 2). During this period, all these cities experienced a high growth rate of motorized vehicles and road infrastructure improvements (primarily road widening and construction of grade separated junctions). A sharp decline can be seen in cycle trips in Delhi from 36% to 7% for the period from 1957 to 2010. Even though diminishing, it is estimated that there will still be at least 8% modal share of non-motorized trips by 2021. (Jain, 2013)

1.3 Trip Length Frequency in Cities

Travel behaviour varies with city size, city structure and available transport infrastructure. National Mission on Sustainable Habitat (NMSH) highlights the need to integrate land use and transportation planning.

Figure 3 indicates trip length frequency from five cities clearly showing that about 80% of the trips are shorter than 3 km. About 70% of the trips are about 10km. These trips are ideal for non-motorized modes like bicycles (Tiwari and Jain, 2008; Tiwari and Arora, 2006; Jain and Tiwari, 2008).

1.4 Potential Vs. Captive Cyclists

Cyclists can also be classified into two categories – one who cycles by choice and the other a ‘captive cyclist’ who is bound by economic constraints and does not have a choice. Indian cities are dominated by the latter. The presence of a cycling infrastructure may encourage some choice and recreational use and add to the safety and comfort of the captive users.

The cycle infrastructure would have to address all NMV requirements including safety and the perception of safety. Users who cycle by choice or potential cyclists remains a latent demand primarily due to the absence of dedicated infrastructure. These predominantly include school kids since one-third of trips are of educational purpose. Housewives, old people, young adults etc. also are potential users if a safe and good bicycling infrastructure is available.

Table 1 : Size Classification of various study cities (Tiwari & Jain, 2008)

City Size	Category	Total Numbers & Names of city
10,000 - 1m	Small City	5- Mysore, Rajkot, Alwar, Nanded, Bhubneshwar
1m - 3m	Medium City	10- Vijaywada, Nagpur, Chandigarh, Amritsar, Patna, Jabalpur, Bhopal, Indore, Jaipur, Pimpri, Chindwad
3m - 5m	Large city	3- Pune, Ahmedabad, Hyderabad
5m and above	Mega city	1- Delhi

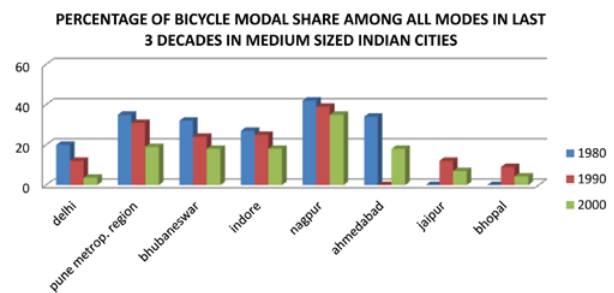
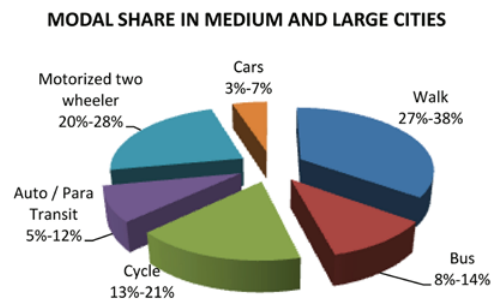

Figure 1 : Modal share (Tiwari & Jain, 2008)

Figure 2 : Trends in cycle modal share (Jain, 2013)

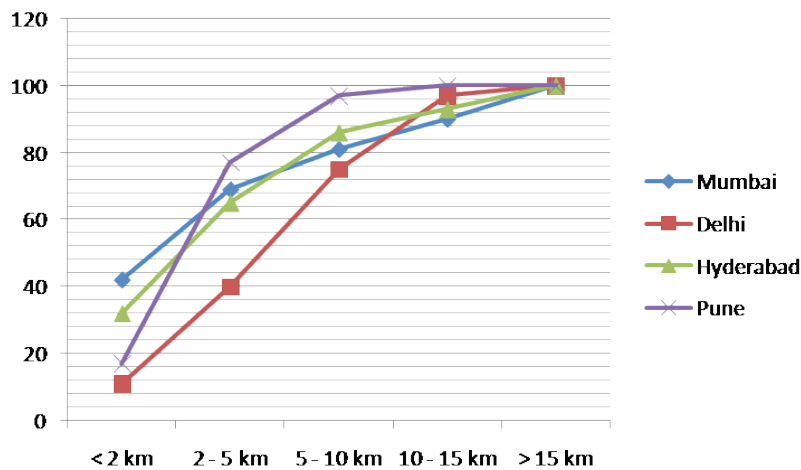

Figure 3: Trip length frequency distribution for Delhi, Pune, Mumbai and Hyderabad (PMC, 2006) (RITES, 2008) (EPTRI, 2005)

1.5 Different Kinds of Cyclists

Figure 4 shows a collage of cycle users on our streets. The collage highlights the wide range of users on cycle and pedal rickshaw both for passenger and goods. Across all age groups and gender, cycle is for all. This is a visual proof of current users seen across India irrespective of the size of the city.

1.6 Cycling and Health

The health benefits of cycling are well known. Significant scientific assessment is now strengthening this and clearly stating how a sedentary lifestyle can lead to increased health risks. Studies from the Health Effect Institute show that people living within 500 meters from the roadside are most vulnerable to vehicular pollution. In cities like Delhi, as much as 55 percent of the population lives in this influence zone. (NMSH, 2011)

Woodcock et al. published a recent article that cycling commuters have (on average) substantially better physical health than commuters using other modes of transport. (Woodcock, et al., 2009).

The promotion of active transport (cycling and walking) for everyday physical activity is a win-win approach; it not only promotes health but leads to positive environmental effects; this is so especially if cycling and walking replace short car trips. Cycling and walking can also be more readily integrated into people's busy schedules than, for example, leisure-time exercise. Health Economic Assessment Tool (HEAT) for walking and cycling ((WHO), 2011) strongly underlines these benefits.

A reduction in blood pressure of 10/8 mm Hg is observed among hypertensive patients who cycle regularly. (Fagard, 1995) 30 minutes of brisk cycling a day, on most days, even if carried out in ten to fifteen minute episodes, reduces the risk of developing cardiovascular diseases, diabetes and hypertension and helps control blood lipids and body weight. Chances of getting a heart disease are likely to be cut in half with brisk cycling on a regular basis. The likelihood of getting strokes, diabetes and some kinds of cancer will also be reduced. This reduces stress and helps reduce weight. The study by Thompson and Rivara has already established that the person in a car breathes in more exhaust pollutants than the one riding a bike under similar circumstances. (Thompson MJ, 2001)

1.7 Cycling and Safety

In Indian cities, 50 – 80% of road related injuries victimize pedestrians and cyclists. Reported road fatalities in India had been increasing by 2000 every year (Ghate & Sundar, 2010).

Figure 5 shows the fatalities by road user type. In all cities, approximately 50% of the total fatalities in each city is that of NMT users: pedestrians and cyclists. In all the cities, vulnerable road users (VRU – pedestrians, bicyclists and motorised two wheeler occupants) constitute more than 80% of all fatalities irrespective of the overall death rate. The data indicates a high association of buses and trucks and a surprisingly significant involvement of motorised two wheelers (MTWs) in VRU fatalities suggesting that it is partly due to the fact that the pedestrians and cyclists have to share the curb side lane with these vehicles in the absence of adequate sidewalks and cycle lanes.



Figure 4 : Various NMT users across India (Source PSDA, SGArchitects, Rajinder Ravi, IDS, Anvita Arora)

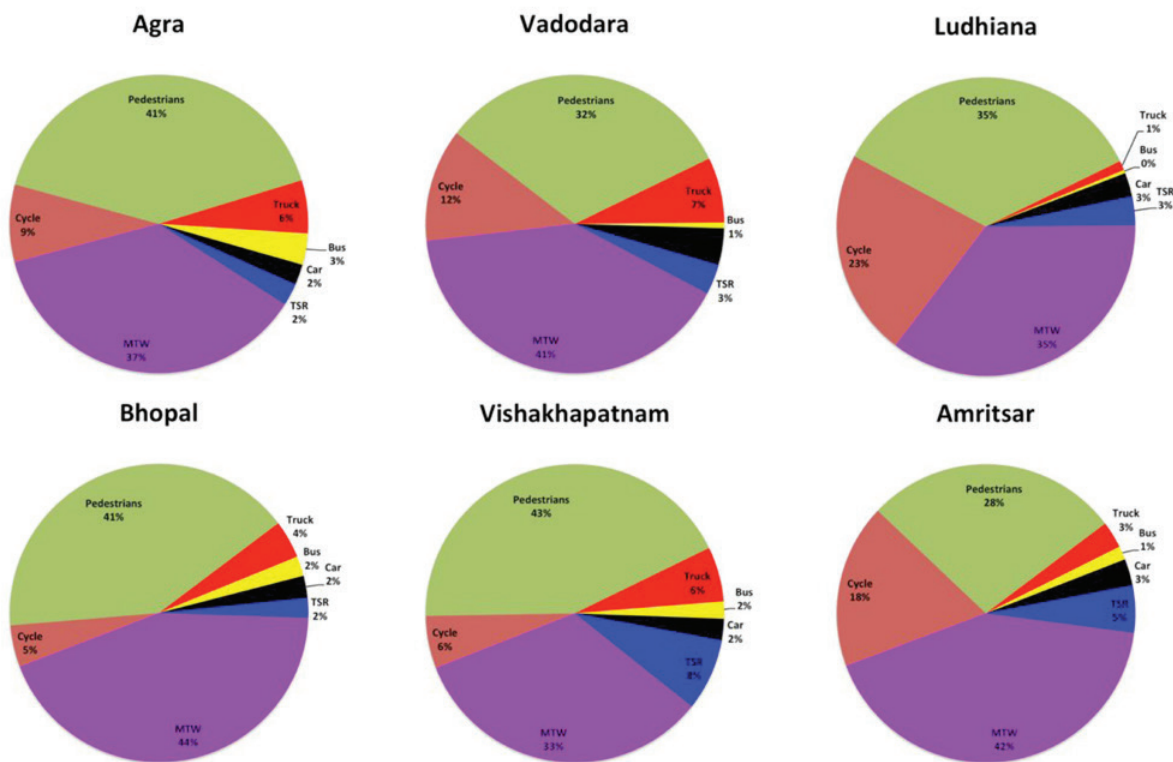

Figure 5 : Road Traffic fatalities by road user type in six selected cities (TRIPP, 2012)

1.8 Cycle and the Environment

Cycles generate no noise pollution and emit no emissions. A better cycle infrastructure can play an important role in increasing the modal share of cycles, reducing air pollution and the adverse health effects of pollution. Estimations for Delhi showed a 28% reduction in fuel consumption and a 29% reduction in health externalities related to air pollution. (Tota, April 1999)

Important health gains and reductions in CO2 emissions can be achieved through replacement of urban trips in private motor vehicles with active travel in high-income and middle-income countries. The combination of reduced reliance on motorised travel and substantial increase in active travel with vigorous implementation of low-emission technology offers the best outcomes in terms of climate change mitigation and public health.

1.9 Current Indian Policy & Guidelines

The **National Urban Transport Policy** (NUTP, 2006) acknowledges the fact that there are certain sections of society, especially the non-motorized commuter groups which face problems of mobility. It notes “... the cost of travel, especially for the poor, has increased considerably. This is largely because the use of cheaper non-motorized modes like cycling and walking has become extremely risky, since these modes have to share the same right of way as motorized modes. Further, with population growth, cities have tended to expand in size and increased travel distances have made non-motorized modes difficult to use. This has made access to livelihoods, particularly for the poor, far more difficult. This target of equity can be achieved by reserving corridors and lanes exclusively for public transport and non-motorized modes of travel....” The Central Government decided to give funding support and priority to the construction of cycle tracks, under the Jawaharlal Nehru National Urban Renewal Mission* (JnNURM, 2005-12), to enhance safety and the use of non-motorized modes, for possible replication in other cities.

The dated **Indian Roads Congress** (IRC) lays the guidelines for street planning, design and construction of urban roads in plain areas (IRC: 106-1990; IRC: 70-1977; IRC: 11-1962; IRC: 86-1983; IRC: 35-1970; IRC: 92-1985; IRC: 35-1997; IRC: 67-2001; IRC: 98-1997). Many of them consider cyclists on the carriageway to be causing hazards for themselves /others and impeding the free flow of traffic. Many of these recommendations are not relevant anymore, especially given the new research and understanding on cycle planning and integration. National road transport and safety authorities are preparing to update and rewrite many of these urban roads code for promoting safe cycling. The following table highlights the problems and missing information in the IRC codes pertaining to design of urban roads that do not address the requirements of cyclists as a user.

The National Mission for Sustainable Habitat on urban transport addressed the issue of mitigating climate change by taking appropriate action with respect to the transport sector such as evolving integrated land use and transportation plans, achieving a modal shift from private to public mode of transportation, encouraging the use of non-motorised transport, improving fuel efficiency, and encouraging the use of alternate fuels, etc. evolving strategies for adaptation in terms of realignment and relocation, design standards and planning for roads, rail and other infrastructure to cope with warming and climate change. The parameters addressed through NMSH are public health, vehicle emissions, and vulnerability of walkers and cyclists to road side exposure, transport and climate, equity and access for the poor.

Table 2 : IRC Codes pertaining to design of urban roads and cycle infrastructure

Code	Year	Title	Problem Identified
IRC: 106	1990	Guidelines for Capacity of Urban Roads in Plain Areas	<ul style="list-style-type: none"> Absence of identification of cycle as a mode in the capacity norms Measures to improve capacity suggest imposing restrictions on movement of slow vehicles etc in peak hours
IRC: 70	1977	Guidelines on Regulation and Control of Mixed Traffic in Urban Areas	<ul style="list-style-type: none"> recommends physical segregation of lanes for cycles; time related restrictions on certain kinds of traffic or directional restrictions. Restricting slow moving vehicles like cycles on certain roads during peak hours is also recommended.
IRC: 11	1962	Recommended Practice for the Design and Layout of Cycle Tracks	<ul style="list-style-type: none"> It is unable to define the provision of cycle infrastructure across all types of roads Identified pedal bicycle as the only mode considered for provision of cycle tracks. This restricts the lane widths of cycle tracks. Mentions that cycle track are desirable and not mandatory on both sides of the road Cycle tracks should be constructed beyond footpaths. For marking, signages and other details no reference has been indicated and left at the discretion of the designer. Parameters like horizontal curves, vertical curves, sight distances, lane widths and clearances need to be carefully relooked since they are for motorised vehicles and might not be aligned with the usage of the cycle infrastructure.
IRC: 86	1983	Geometric Design Standards for Urban Roads in Plains	<ul style="list-style-type: none"> It focuses on the safe and economic operation of the vehicle. The design speed limits and design standards have to be brought into conformity with the requirements of sustainable safety principles accepted universally.
IRC: 35	1977	Code of Practice for Road Markings (First Revision)	<ul style="list-style-type: none"> Does not address cycle infrastructure when segregated. Does not cover all situations faced by the cyclist in a cycle lane. Waiting area for cyclists missing at intersections and minor crossings. Parking spaces for NMT is missing
IRC: 92	1985	Guidelines for the Design of Interchanges in Urban Areas	<ul style="list-style-type: none"> Indicates the provision of grade separated cycle ways Mainly focuses on highways. Parameters such as clearances, etc indicate focus over vehicular traffic Sees cycle and slow moving vehicles as a major threat Expects for slow vehicles to use the longer route; intersection design does not meet cyclists requirement of directness. Cycle infrastructure suggests a lane in such high speed road environments which is unsafe. Bans movement of slow traffic on elevated roads.
IRC: 98	1997	Guidelines on Accommodation of Utility Services on Roads in Urban Areas (First Revision)	<ul style="list-style-type: none"> Location of services and utilities w.r.t the cycle infrastructure has not been addressed. Proposed cross-sections indicating the location of the services within the ROW highlight various impediments to cycle infrastructure. Lighting levels and preferred location of services w.r.t to allocated zone not addressed.
IRC: 69	1977	Space Standards for Roads in Urban Areas	<ul style="list-style-type: none"> Cross-sections for situations not given Location of cycle tracks behind service roads. This is ignoring the main requirement of captive cyclists. Width of cycle track should be unusable for a three wheeled cycle rickshaw. The cross sections can be updated and redesigned appropriately to meet the needs of NMT.
IRC: 65	1976	Recommended practise for traffic rotaries	<ul style="list-style-type: none"> It refers to the use of IRC 11:1962. The key problems have already been indicated above. Modern roundabouts are better designed to address traffic calming for all users and road types. The discussion is completely missing.

1.10 Examples from Indian Cities

NEW DELHI



Cyclist along road edge with bus in unsafe condition
Source : Anvita Arora

PUNE



Segregated cycle track on Solapur Road
Source :Prasanna Desai Architects

HYDERABAD



School girls walk the bicycle on carriageway.
Source : Anjalee Aggarwal

NEW DELHI



Cycle track on BRT corridor Source : TRIPP, IIT Delhi

INDORE



Vendor on carriageway on BRT corridor
Source : Anvita Arora

JAIPUR



Passenger Rickshaws on carriageway
Source : Ruchi Varma

CHENNAI



Provision of cycle lane with interlocking tiles along road
Source : Anvita Arora

VIJAYWADA



Bicycles and Rickshaw on the street of vijaywada
Source : Ravi Gadepalli

AHMEDABAD



Cycle parking along carriageway with other modes on Janmarg pilot
Source : Anvita Arora

Figure 6 : Examples from various cities in India

1.11 Myths

CYCLE SHOULD ONLY BE IN INTERNAL ROADS.



India has a high share of current users and they will prefer using the road network which is more direct and faster.

Photo: TRIPP, IIT-Delhi

NMT = BICYCLE.



NMT also covers tri pedal rickshaws and four wheeled vendor trolleys apart from others used for inclusive mobility.

Photo: Rajendra Ravi, IDS; Satyajit Ganguly, SGArchitects

CYCLE IS USED PREDOMINANTLY BY MEN.



A large number of women of all age groups use the bicycle and rickshaw for work and commutation.

Photo: Rajendra Ravi, IDS

SEPARATE TRACKS ARE REQUIRED ONLY WHEN VOLUME OF CYCLISTS IS HIGH



Separate cycle tracks are required on all high speed roads more than 30 m ROW to prevent conflict.

Photo: Satyajit Ganguly, SGArchitects

THERE IS NO SPACE FOR CYCLE INFRASTRUCTURE.



There is a lot of wasted space on the road. Equitable road space allocation can be easily done according to the classification of road to provide usable and safe cycle infrastructure

Photo: Sandeep Gandhi, SGArchitects

IN METROPOLITAN CITIES TRIP LENGTHS ARE LONGER. PEOPLE HAVE TO TRAVEL LONGER DISTANCES



Nearly seventy percent of the trips are shorter than 10 kms regardless of city size. There are about a million cyclists in metropolitan cities like Delhi. The average trip length is about 10km.

Photo: Rajendra Ravi, IDS

Figure 7 : Myths

2 Planning for Non-Motorised Transport

The process of planning for a cycle friendly infrastructure in a city must start by understanding the cyclists or cycle rickshaw pullers and their cycles and cycle rickshaws. Non-Motorised Transport (NMT) planning needs to be carried out at the city level for the entire urban agglomeration area in such a way that the various NMT improvements taken up at the street, corridor or area level lead to an overall improvement in the attractiveness of the NMT. A Non-motorized master plan (NMTMP) needs to be prepared for the city which includes the various components of NMT planning i.e. the NMT network plan for the city, infrastructure measures needed at corridor/area level for the overall network improvement and a phase-wise implementation plan for the proposed infrastructure and network plan. The entire planning process for preparation of the NMTMP of a city has been explained in this chapter, the outline of which is presented in Figure 8.

The planning for NMT modes cannot be carried out in isolation but needs an integrated approach addressing the needs of all road users. Planning for cycle and pedestrian paths, bus lanes and stops, integrating with metro station access, on-street parking, para transit stands, hawkers; etc. all require to be integrated in the planning process to ensure that the NMT infrastructure functions as planned.

One of the debates at the city level is on where the NMT infrastructure needs to be planned, especially the cycle tracks. Often planners target industrial areas or educational areas etc. considering the large volumes of cyclists that these areas attract. However the Bicycle Master Plan for Delhi (2008) illustrates that if we draw a buffer of 3-5 km around all industrial areas, educational institutes, wholesale areas, bus stations, low income areas and other origins and destinations of cyclists, it would in fact cover the entire city (ref Figure 9 and Figure 10). Therefore it is necessary that NMT Planning is carried out for the entire city rather than for a few pockets.

Addressing the NMT users requires different interventions in different areas. While access for NMT users is needed everywhere, specific interventions may be needed for cycle rickshaw access as in streets with markets, etc. depending upon the land use type in the area.

At a network level, the NMT network is far denser than the MV network and the public transit network. While they overlap, the NMT network needs to be fine-grained with the highest connectivity – in effect there may be streets which are NMT only, but all MV and PT networks should have NMT integrated in their plans. The Figure 11 and Figure 12 illustrates this.

2.1 Planning Requirements

While NMT planning is a city-wide intervention, it is important to understand that NMT trips are primarily short trips. These short trips in most cities form the majority of the trips made – in smaller cities most destinations are within walking and cycling distance. In larger cities, the NMT trips also consist of access trips to public transit stations and intermediate public transport (IPT) stops like auto rickshaw stands.

Whatever may be the purpose of the trip the planning process needs to ensure that the NMT users have direct, coherent, safe, attractive and comfortable routes to complete the trip. Directness and coherence are physical planning characteristics. While safety, attractiveness and comfort can be ensured by design, there are also perception based characteristics which may differ for different types of users. Captive users are more concerned about undertaking their daily journey faster, with lesser effort and higher comfort. Hence they prefer the road network to be cohesive, direct and comfortable (in terms of riding quality). Safety and attractiveness are found to be rated lower in priority for captive riders. However, potential users have a higher preference for safety and attractiveness as their journey is likely to be shorter and recreational in nature. Clearly, planners need a balanced approach in design providing all the requirements in the desired package for each category of user. (Arora, 2010)

The three major components needed for an efficient city level NMT network are explained below.

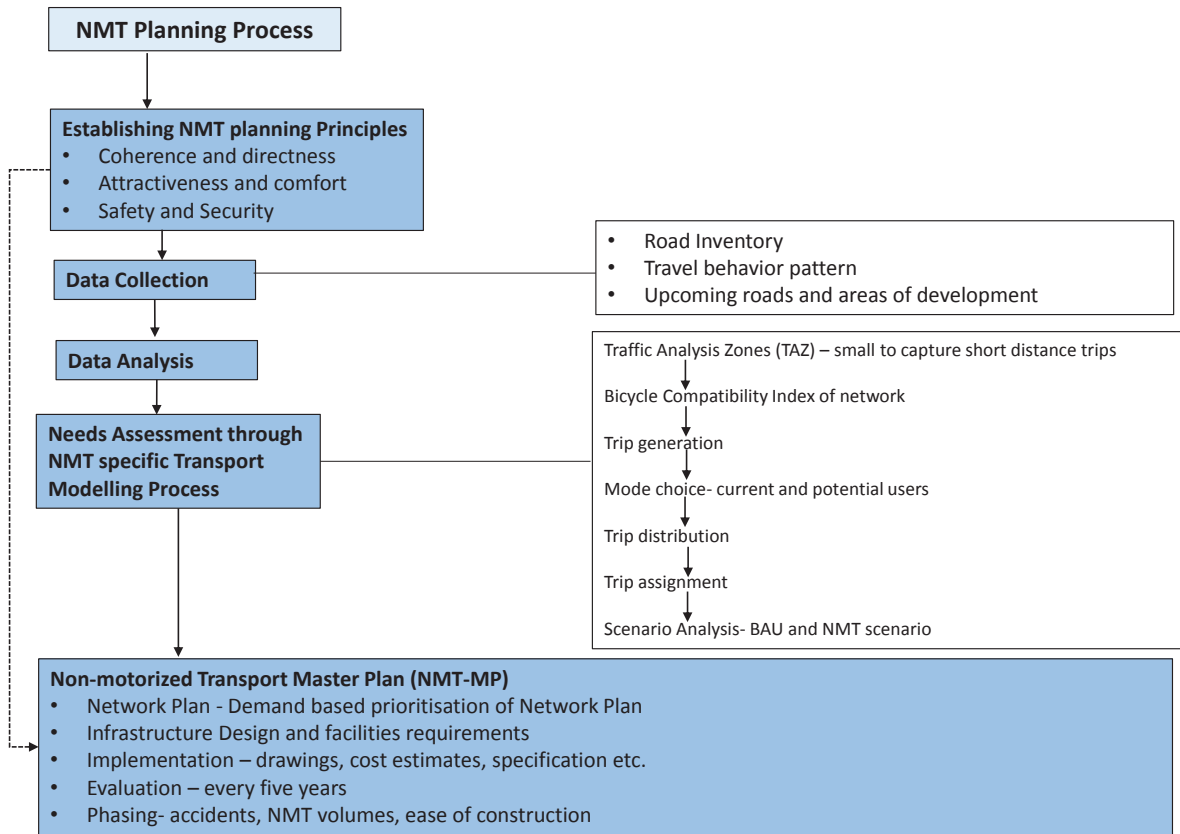

Figure 8 : The outline of the planning process

Coherence and directness (Connectivity)

Cyclists and pedestrians use a given infrastructure only if it provides a continuous connection between their origin and destination. To make the total city NMT friendly, the entire network needs to be cohesive. The lower the travel time, the higher the directness. At network level, a cohesive network would involve minimal detours for cyclists accessing it. For captive users, the directness offered by a NMT infrastructure should be higher than that offered by the MV network. This is best achieved by overlapping NMT network on MV network and adding NMT only lanes, short cuts, etc. Higher directness can be achieved not just within the NMT network but also on public transport corridors by using walking, cycles and rickshaws as feeders and providing parking and transfer infrastructure at stations to minimize delays. Hence, there should be a complete NMT network connecting all destinations integrated with public transport lines and road networks. Figure 11 below gives the motorized network coverage which is lesser than the NMT network and therefore a larger coverage of roads needs to be captured so as to attain a complete NMT network in a city.

Attractiveness and Comfort

Due to their slower speed compared to motorists, NMT users are sensitive to microenvironments on the streets and this may affect their route choice or decision to walk or cycle. To make the NMT network attractive planners may choose to plan some activities such as cycle parking, small hawker spaces or kiosks and street furniture such as trees, fountains, planters, seating, plazas, etc. to break the monotony of the route and introduce visually and spatially attractive elements more apt to the scale of NMT users instead of stark, monotonous, long, barren walls.

Factors adversely affecting the comfort of NMT users by choice are: traffic bottlenecks, steep gradients, nuisance caused by traffic noise and emissions, bad riding quality, presence of obstructions resulting in frequent braking or slowing down, etc.

Safety and Security

NMT users are very vulnerable in the case of crashes. In common practice of increasing NMT safety is to segregate them from motorized vehicles in time and space. For captive users, segregation by time is not a viable option as the journey between work and home is undertaken at almost the same time as other (motorized) modes (especially for shorter trips). Here, the most effective option would be to segregate users into separate tracks or paths along the road network, (especially if the speed limit for MV is over 30 Km/hr). On other streets there is a need to reduce their speed difference by traffic calming without affecting directness or coherence. Other factors affecting safety on the NMT network would include the following:

Provision of segregated track or path for most part of the journey.

- Minimum part of the journey in mixed conditions on dangerous roads.
- Speed reduction by design on roads where NMTs mix with motorized vehicles.
- Limiting number of junctions/crossings on the NMT infrastructure.
- Reduction of speeds of motorized vehicles at crossings and intersections.
- Combining shortest and safest routes.
- Discouraging encroachment by motorized modes such as two wheelers on NMT path/track.
- Improve visibility for both NMT and motorized modes, especially at intersections.

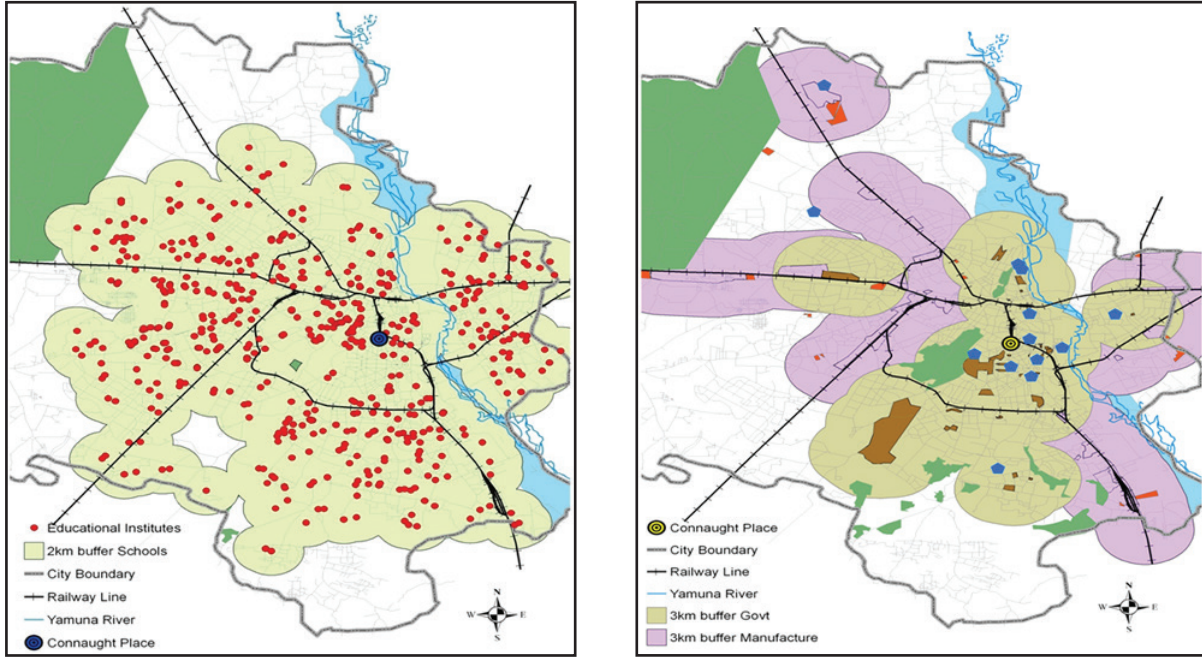

Figure 9 : Left Figure shows 3 km buffer around education institutes and Right Figure shows catchment area of 5km around govt offices, industrial areas (H. Jain, 2008)

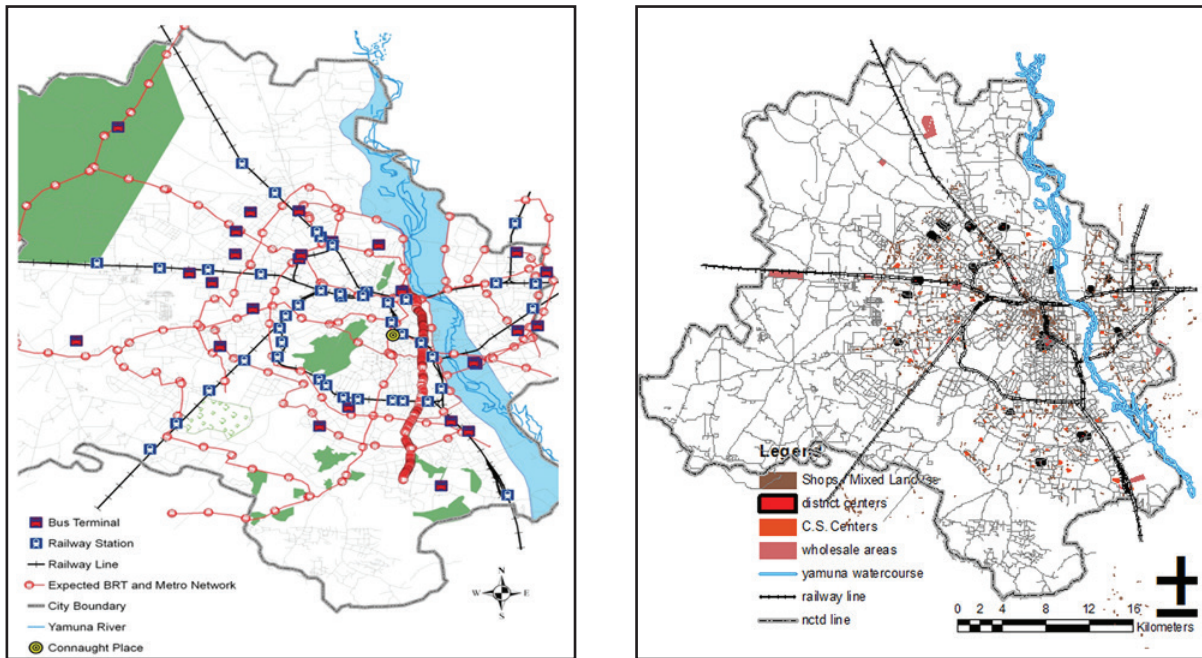

Figure 10 : Left figure Shows location of the transport interchanges: Bus Depots, ISBT, transport centers, railway and metro stations and Right figure Shows locations of major Commercial Centres, District Centres, Shops / Mixed Land Use and Wholesale areas. (H. Jain, 2008)

Security from harassment on the streets also becomes an important consideration for NMT users use especially women and children. Planning and design elements that introduce eyes on the streets – by removing setbacks and compound walls, having active building fronts and mixed land use, and street vendors – should be part of the spatial planning to ensure security. Design level interventions like toilet, street lighting, etc. are critical and will be discussed in greater detail in the next chapter.

A city wide NMT network is created by combining segregated NMT tracks, NMT lanes and traffic calmed areas. Segregated tracks are required on roads where motorized vehicles move at 30km.h or higher speeds. Painted lanes and traffic calming is required on local roads to ensure that motorized vehicles speed remains below 30km.h and cyclists are safe. Figure 11 and Figure 12 shows example from the road network of Vishakhapatnam to illustrate the hierarchy of road networks: the MV network segregated cycle tracks and non segregated lanes i.e. the pedestrian network. Each street of the city needs pedestrian connectivity through low speed streets. These streets can also be used by cyclists since they are low-speed and hence are safe. Some of the streets which are arterial roads and have high speeds and hence need segregated tracks to provide adequate safety for cyclists. The longer distance trips are made by motorised modes, for which the connectivity is provided by the highways, arterial and sub-arterial roads which form the major and minor roads in the motorised mode network. It can be observed that the NMT network is much more fine-grained in nature and needs planning for a much larger network than the motorised modes.

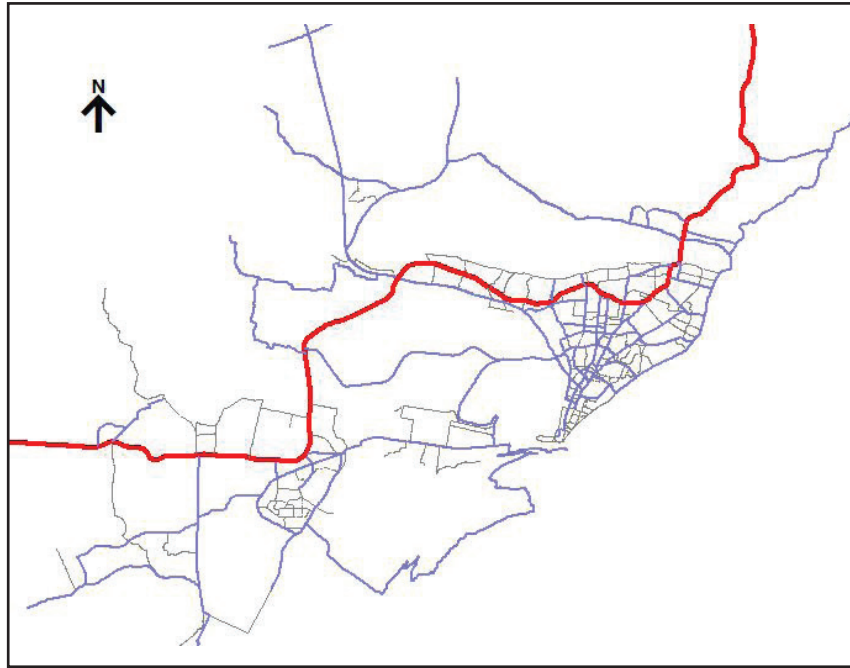

Figure 11 : Motorized Network Coverage of Visakhapatnam City (UNEP, 2012)

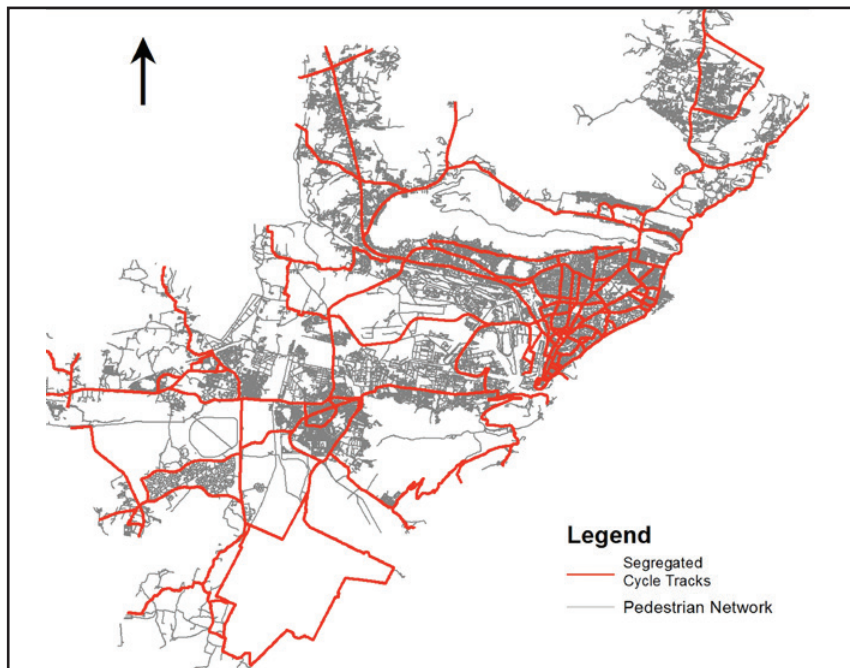

Figure 12 : Non-motorized Network coverage in the City (UNEP, 2012)

2.2 Planning Development Process

The Planning process is a long road from policy to implementation, which runs through an environment in which countless interests vie for the limited resources. Any effort to develop NMT infrastructure has to start with the right policy decisions. These should be Central, State and City level policies such as the National Urban Transport Policy, cleared on April 6, 2006; which states as one of its objectives: “investing in transport systems that encourage greater use of public transport and non-motorized modes instead of personal motor vehicles” (Government of India, 2005). This is followed by the Master Plan or development plans, which includes city level network of NMT routes as well a time bound vision for a NMT friendly city. Working according to a Non-motorized master plan (NMTMP) gives the best chance of protecting the interests of cycle and other NMT users (CROW, June 2007).

2.3 Data Collection and Review of Existing Scenario

Data collection is required to understand the existing scenario of walking and cycling in the city. This broadly comprises of data related to the supply components like the existing infrastructure and the demand components like the travel behavior of various road users, both existing NMT users and other road users. The current section explains the details of data that needs to be collected for NMT planning. Secondary sources of data like the road inventory data of the Municipality, The Comprehensive Mobility Plan (CMP) of the city or other studies like the City Development Plan (CDP), Detailed Project Reports (DPR) for any transportation project or the Master Plan can also be used. This data would later be used to develop a travel demand model. The input parameters and their data sources used for developing a travel demand model are listed in Table 5.

2.3.1 Road Network Inventory

Infrastructure inventory is to be prepared collecting information about the existing level of service and type of infrastructure. Data on roads and infrastructure type is collected for three categories of roads defined as – Arterial or sub-arterial; Collector roads and Local roads based on the ROW and the purpose served. The road inventory for the entire city is developed on GIS platform and using a sample of roads data regarding the amenities and facilities is collected. The requirement of infrastructure to facilitate easy, comfortable and safe mobility for each of the modes is different. It is thus necessary to assess the existing infrastructure with respect to the requirements of each of the NMT users.

2.3.2 Travel Behavior Pattern of User Groups

The travel behaviour of all road users are collected as part of data collection since it is important to understand the behaviour pattern of both the existing NMT users and other road users, who form the potential NMT users of the future. Two important considerations while collecting data on travel patterns is that the collected data should be representative and should study all travel behaviour of individuals within a household, and be segregated by social groups and by trip purpose. In addition, the collected data should also represent the actual travel behaviour of the respondents as well as the rest of the population. Home interview surveys of socio-economic characteristics and travel diary together are effective tools to capture these components. The questionnaire for such surveys needs to be designed keeping in mind the perception of people towards different modes of transport, particularly NMT, in terms of time, cost, comfort, safety and security.

The home-interview or household survey questionnaire can be broadly divided into two sections: Revealed preference survey and stated preference choice. The revealed preference survey must include questions related to information on the socio-economic characteristics of the household and its members as well as their choices under existing conditions. The stated preference choice includes their choices under alternative scenarios (mode choice) or other conditions, which are non-existent. Socio-economic characteristics of the household and personal level information will provide details on the number of members and their details, assets, housing and living conditions, vehicular ownership, accessibility to important destinations and mode choices

Table 3 : Data required for model development

Model Component	Likely Data Sources
Traffic Analysis Zone Map	Derived from Ward Map
Road Network	Derived from Property Tax Data, Primary Data collected for road inventory & Link speeds and secondary data on road widths
Trip Production Patterns	Household Interview Data Comprehensive Mobility Plan of the city
Trip Attraction Patterns	Land Use Data from Master Plan and Building wise usage type from Property Tax Database Economic census data
Trip Distribution	Trip length distribution patterns from Household Interview data to calibrate the Gravity Model
Base Mode Shares	Household Interview Data Comprehensive Mobility Plan of the city
Traffic Assignment	Traffic Volume Counts used for network calibration

along with their opinions. The other part of the revealed choice survey includes the travel diary, including details of trips, mode choices, origin, destination, travel time, etc. The stated preference survey involves individual mode choice in two alternative scenarios with different conditions on travel time, efficiency, safety, comfort, etc. Table 4 and Table 5 represent the data derived from the inventory survey and household interviews.

2.4 Needs Assessment Through Travel Demand Modelling

The travel demand model is required to replicate the road network and travel patterns of the city in modelling software and to test for various measures that can be taken to improve the existing NMT system. This modelling process should be a part of the Comprehensive Mobility Plan (CMP) of the city integrating the planning processes for NMT with other modes. If not, atleast the same data as that of the CMP needs to be used for this process. Also, if the CMP data is not available the NMT specific data needs to be collected for developing this model which is listed in the next section.

However, in case the modelling is not possible, the combination criteria given for cycling in Table 9 and Table 10 can be used to determine the priority of routes for the base year. Horizon year hierarchy can be made based on the available and proposed ROWs in the Master plan or the CMP of the city. Moreover, infrastructure for pedestrians is necessary throughout the city on all roads and it doesn't require travel demand modelling to identify routes and provisions. Pedestrian specific solutions can be identified with the help of other codes developed by the Indian Road Congress (IRC) like IRC-11. Therefore, the modelling process explained in this chapter is needed only for cyclists.

The overall demand modelling framework for NMT is the same as that of other motorised modes: it follows the same four stage modelling process. The existing toolkits for urban transport planning only explain the modelling framework needed for motorised modes¹. The additional steps that need to be taken into consideration for NMT planning are explained in this chapter. However, this process is not used to forecast demand but the whole 4 step modelling framework is used to model NMT specific improvements in the network which has an impact on mode choice. This includes developing a network for the NMT system, identifying the missing links in the existing NMT network and prioritizing the NMT corridors for future development. Software's like Quantum GIS, ArcGIS, TransCAD, CUBE, VISUM, EMME, Omni Trans can be used to create the travel demand model of the city. However it should be noted that these softwares are made primarily to model motorized modes like cars, two-wheelers and buses. Omnitrans is the only software among these that has specific modelling capabilities relating to NMT users. Hence adequate care should be taken in specifying the modelling parameters to suit the softwares for NMT users. Various stages of the modelling procedure have been explained in the following sections.

2.4.1 Traffic Analysis Zone (TAZ) Map Creation

The accuracy of the travel demand model depends heavily on how accurately the Traffic Analysis Zones (TAZ) and the road network replicate the actual scenario in the city. Entire planning area delineated for the study is divided into Traffic Analysis Zones (TAZ). These TAZs act as units of disaggregation for trip productions and attractions from various parts of the city. Municipal wards in the core area are generally small and are smaller than 1.5 sq. Km. In area and hence can be retained as they are. The larger wards i.e. the one's having areas more than 1.5 sq. km and two-three pockets of development need to be split into smaller TAZs.

¹<http://www.iutindia.org/CapacityBuilding/Toolkits.aspx>

Table 4 : Data derived from the infrastructure inventory surveys for cycle users (UNEP, 2012)

Data required		Description	Data level
Infrastructure for cycles and cycles rickshaws and Pedestrians	Lanes	Cycle lanes/tracks, foothpaths	Citywide1
		Width of cycle lanes/tracks, footpath	Citywide1
		Both sided/single sided	Citywide1
		Encroachment by other activity/vehicles	Sample2 or citywide1
		Lighting	Sample2
		Pavement condition Barriers to access	Sample2 or citywide1
	Intersection treatment	Signalized intersections	Sample2 or citywide1
		Traffic calming tools	Sample2
		Traffic calming for access to properties	Sample2
	Parking	Number of parking	Citywide1
		Distance of parking from PT stop	Citywide1
		Parking charges	Citywide1

Table 5 : Travel Behavior Data (to be collected as a part of Household surveys) (UNEP, 2012)

Data required	Description
Personal information	Age
	Gender
	Occupation (to get idea about current and future travel demand/ need)
	Monthly income and Monthly expenditure on transport
	Migration status
	Vehicle ownership and age of vehicle
Trip making information	Trip purpose
	Trip origin
	Trip destination
	Travel distance
	Mode used
	Total travel time
	Total travel cost
Transport infrastructure rating for cycling	Perception about Safety
	Perception about security
	Perception about comfort
	Perception about cost

Smaller TAZs are formed in such a way that the landuse type and trip making characteristics of all households in a particular TAZ are nearly uniform throughout the TAZ. Figure 13 shows one such TAZ map created for the city of Visakhapatnam.

2.4.1.1 Creating the Road Network

Trips between various TAZs are made using the road network of the city using various modes. The road network for the model needs to be created based on the road inventory data of the city. Care should be taken to represent even minor links in the network since NMT users sometimes prefer the interior roads which are safer than the arterial roads. Network attributes required for modelling like link speed, travel time, volume-delay functions, link-wise impedance and capacity (only needed if it is constrained for cyclists) should be included based on various primary and secondary data sources. This network is used for further four-stage modelling.

2.4.2 Trip Generation

This step involves estimating the number of cycle trips produced and attracted to each TAZ. The walk and cycle trips are derived as a proportion of the overall trips produced and attracted to each TAZ. Trip production is dependent on socio-economic characteristics of households within the TAZ while trip attraction depends on the land-use type of the TAZ².

2.4.2.1 Trip Production

Household interview data is normally used to estimate trip production trends for various types of households using the following steps:

- Purpose wise trips produced in each household are derived as a function of the socio-economic attributes of the household like household size, income and vehicle ownership.
- Total number of households in each TAZ is derived from the census data or the property tax database or any other relevant database and its total households and the number of trips produced are estimated.
- The socio-economic characteristics of each TAZ are derived from the household interview data.
- If detailed household level data is not available, TAZ level data and parameters like TAZ population, (including informal low income settlements) employment opportunities etc. are used to derive the productions for each TAZ

2.4.2.2 Trip Attraction

The attractiveness of a zone is a function of the type of land-use of that zone. For example, residential land use produces trips (where trips originate) while commercial, institutional, industrial areas and informal employment zones typically attract trips (where trips end). Hence the existing land use mix is considered as the critical variable in determining the trips attracted to each TAZ. Land use data at the city level is provided by the Master plan of the city, but they are only indicative as the land use allocation in the master plan and its actual usage varies widely.

Property tax data from the municipal corporations maintain building wise land use type and its plinth area. Types of land use in the buildings include: Residential, Commercial, Educational, Industrial, Public Use, Shops, Hospital, Cinema/Pub Entertainment, Others. Except residential, all other land use types attract trips. Hence, the total plinth area of each type of attracting land use can be calculated and used as a measure of attractiveness of the TAZ.

²Ravi Gadepalli, Muslihuddin Jahed, K. Ramachandra Rao, and Geetam Tiwari. "Multiple Classification Analysis for Trip Production Models using Household Data: Case study of Patna, India." Journal of Urban Planning and Development (2013)

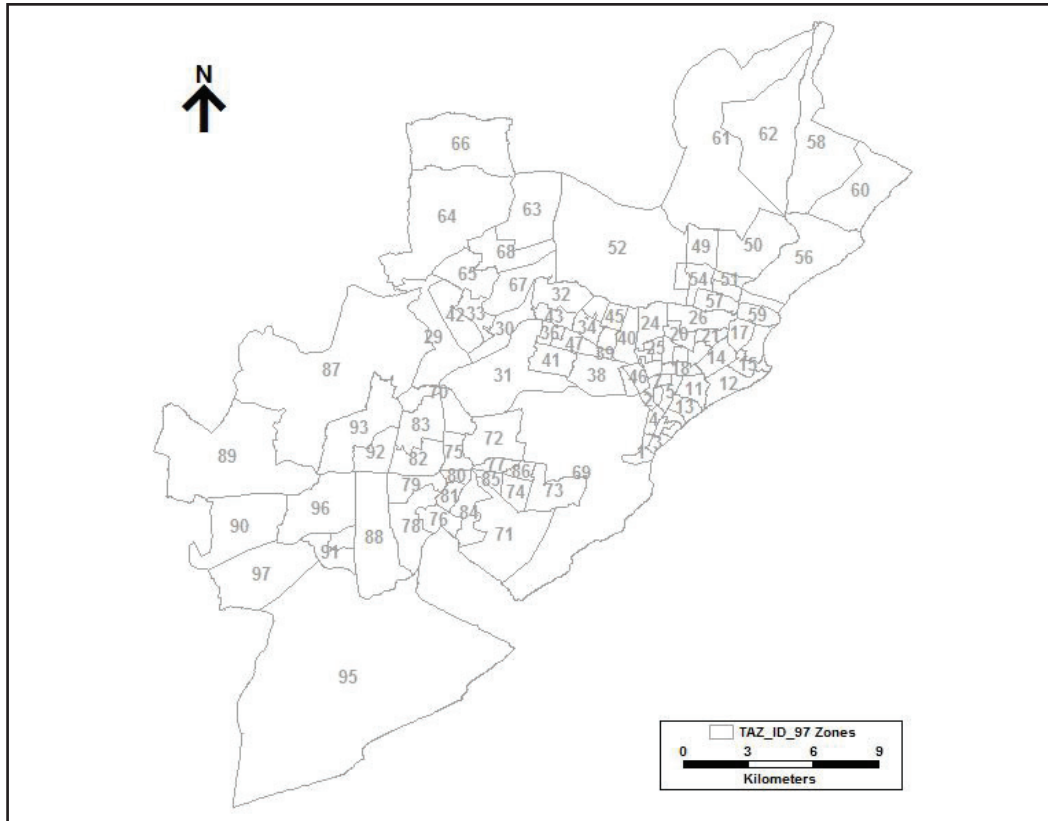

Figure 13 : TAZ map showing the 97 zones (UNEP, 2012)

Purpose wise trips attracted to each zone from the household interviews is correlated with land use types in each TAZ using multiple linear regression technique to derive the relation between the trips attracted and the land uses of the TAZ. Based on these equations, the number of trips attracted to each zone is re-calculated using the equations. This will however only give the number of trips at the scale of the sample size of data, since the sample trips are used for deriving the equation. Therefore these attractions are used as the relative attractiveness of each zone. The attractions of each zone are then up scaled proportionally to the total attractions based on the total trips produced for each purpose. Hence, the Production-Attraction (PA) table is prepared for the total trips made in the city for each trip purpose.

Peak Hour PA Table

The Production-Attraction (PA) table is prepared for the total trips made in the city for each trip purpose. The peak hour PA table is derived based on the hourly variation of the trips of each purpose. Based on available traffic volume counts, the peak hour for the city is identified and this is taken as the peak hour for the demand model. The PA table for each purpose is derived for the peak hour according the proportion of trips observed.

2.4.3 Current and Potential Cycle Users and Trip Distribution

Existing NMT trips are captive in nature since they cannot afford other modes of transport and are exposed to high risk to accidents and pollution. Other than these captive users there are a large number of potential users. Indian cities are characterized by mixed land use structure, high density and compact city development. Therefore the majority of the trips made are shorter than 5 km. Improving NMT infrastructure that provides safe, secure and direct access to pedestrians and bicyclists can help attract potential demand.

Modal shift to NMT can be estimated using a combination of stated preference (SP) surveys and trip length distribution of cities. In SP surveys, improvement in infrastructure and the resulting impact on attributes like comfort, safety and security are presented to the respondents and they choose the most preferred mode for their existing trip in the improved infrastructure scenario. These include measures like better cycle paths, parking provision for cyclists, dis-incentivising measures for private modes, latent demand for cycling, effect of new metro in the city, etc. Based on this, likely modal shifts from different modes based on trip lengths can be determined.

However there are two points of concern. Firstly, people may be pre-biased towards a particular mode resulting in more preference towards that mode. Secondly, respondent do not necessarily do what they say in stated preference surveys. To account to this variation, two scenarios can be created i.e. maximum shift scenario (MSS) and least shift scenario (LSS) as shown Table 6.

For the base year model, mode share split is carried out before the trip distribution. The TAZ wise mode-share values can be derived from the HH Interview data and applied to the PA table to get the mode-wise PA table for all zones. The PA table containing inter-zonal walking and cycling trips is used as the input for trip distribution.

2.4.4 Trip Distribution

Trip distribution is used to derive the Origin-Destination (OD) matrix from the PA table. The Gravity Method is generally adopted for trip distribution. In this method trips between zone i and zone j are distributed in proportion to the number of trips produced in i, number of trips produced in j and in the inverse proportion of the impedance between these zones i.e. travel time, travel cost, relative safety, etc.

A holistic model to calculate the impedance between zones is the Bicycle Compatibility Index (BCI). BCI reflects the safety and comfort levels and perceptions of bicyclists based on observed geometric land use, street environment and operational conditions of the road network. The four parameters which affect cycle compatibility as measured by their variables are -

Table 6 : MSS and LSS Scenarios (TRIPP, 2011)

Description	Share of trip shorter than 5 km shifting to NMT	
	Improving only NMT infrastructure	MSS
LSS		10% from MTW, three-wheelers & Bus

Table 7 : Parameters and their weightages to compute Bicycle compatibility index (BCI)³

Level 1	Level 2	Cyclists Score	% weight attached	Captive value
Physical safety		812	29.74	
	Less frequency of buses in curb lane	812	29.74	8.84
	Low speed of motorized vehicles	790	28.94	8.61
	Lesser Volume of motorized vehicles	605	22.16	6.59
	Dedicated bicycle tracks	523	19.16	5.7
Social security				
	Formal Land use aspects (diversity/intensity of mix)	722	23.45	6.79
	Informal LU on roadside	716	29.23	8.46
	Lighting	718	22.3	6.45
	Other bicyclists/pedestrians	574	25.03	7.24
Barriers		523	19.16	
	Pedestrians on the road	698	23.56	4.51
	On street parked vehicles	688	25.19	4.83
	Poor Pavement quality	716	27.22	5.22
	Gradient	629	24.03	4.6
Intersections		605	22.16	
	Crossings signalized	710	26.01	5.76
	Crossings un-signalized	759	27.8	6.16
	Roundabouts	683	25.02	5.54
	Uncontrolled MV entry/exit	578	21.17	4.69

Table 8 : Example Mode-Wise Average Occupancy*

Mode	Average Occupancy
Car	2.5
2-Wheeler	1.5
Bus	30
Auto	4.9
Cycle	1

*Source: LCMP Visakhapatnam

³Himani Jain,2012, Development of a bicycle demand estimation model incorporating land use sensitive parameters: Case of Pune city, India

- Physical safety - volume of motorized vehicles, speed of motorized vehicles, frequency of buses and other heavy vehicles.
- Security- land use mix and density, informal sectors on road side, lighting, other bicyclists and pedestrians.
- Barriers and attractiveness- parked vehicles, pedestrians on the road, bus stop density, pavement quality, shade, gradient, etc.
- Intersections- density of non-controlled vehicular access, type and level of controlled vehicular access (signalized intersections).

These weightages are derived based on detailed field studies to determine user preferences. If these data are not available, the BCI for various links can also be derived based on the existing infrastructure data collected through road inventory surveys. Scoring shall be given to various components of NMT infrastructure like width of NMT path, segregation tools, encroachments, visibility and other relevant information. The aggregate score of each link is multiplied by the travel time or length of the link to derive the BCI of that particular link.

The BCI derived for each link is aggregated to derive the cycling impedance between various OD pairs and is used in the Gravity function for trip distribution to derive the Origin-Destination (OD) matrix for current and potential cyclists in the city. Table 7 shows the various parameters and their weightages required to calculate the BCI between various zones.

2.4.5 Traffic Assignment and Calibration

The person trip OD matrices for current and potential users are converted to vehicle trips based on the average occupancy in Table 8 observed in each mode from the occupancy survey carried out in the city.

However, the floating population coming into the city through the numerous entry points have also been captured from OD surveys at these locations. These sample surveys are up scaled based on the traffic volume counts at those locations. The OD matrices from these surveys are added to the OD from trip distribution to develop the overall OD matrix of the city.

The mode-wise calibrated OD matrices derived from the above step are assigned on to the road network using All or Nothing (AON) method in general by considering the minimum BCI or travel distance between ODs of the cyclists as the determining factor for route choice. Since most links are assumed to have enough capacity for cyclists and since cyclists are sensitive to safety and security issues more than the speed, AON method is adopted.

2.4.5.1 Network Calibration

The link flows observed from traffic assignment are compared with the actual cycle traffic flows observed from traffic volume counts conducted at various locations across the city. If it is observed that the link flows from traffic assignment vary from the traffic volume counts the network needs to be re-checked for its accuracy. Some missing links in the road network are identified through this procedure. However, the larger contributing factor to this error in the OD matrix can be derived from trip distribution. OD matrix had to be re-calibrated for it to match the traffic volume counts. For this, an iterative process available in modelling software's called the OD matrix estimation (TransCAD)/ t-flow fuzzy (VISUM). Using this procedure the network is calibrated to match the actual volume counts observed on ground.

2.5 Horizon Year Scenarios Analysis

The base year model developed above is used as the base to model the likely cycle demand scenarios for the horizon year for which the NMT master plan is being prepared. The scenarios predict the likely trends of development of socio-economic and infrastructure characteristics of the city in the future and model the likely impact of such growth for the cyclists. A twenty year period is considered as the long term horizon year for scenario development, since it is considered to be a long enough period to estimate the future growth.

The various NMT scenarios and recommendations can be carried out for three horizons of growth ; short term (5 years), medium term (10 years) and long term (20 years). e travel demand modelling for the horizon years includes population projections in the first step. The same methodology of four stage modelling procedure as applied for the base year is applied for the horizon year i.e. 20 year long term horizon. The Master plan of a city is the guiding document for its pattern of growth. The figure below explains stepwise how the BAU scenario is analysed.

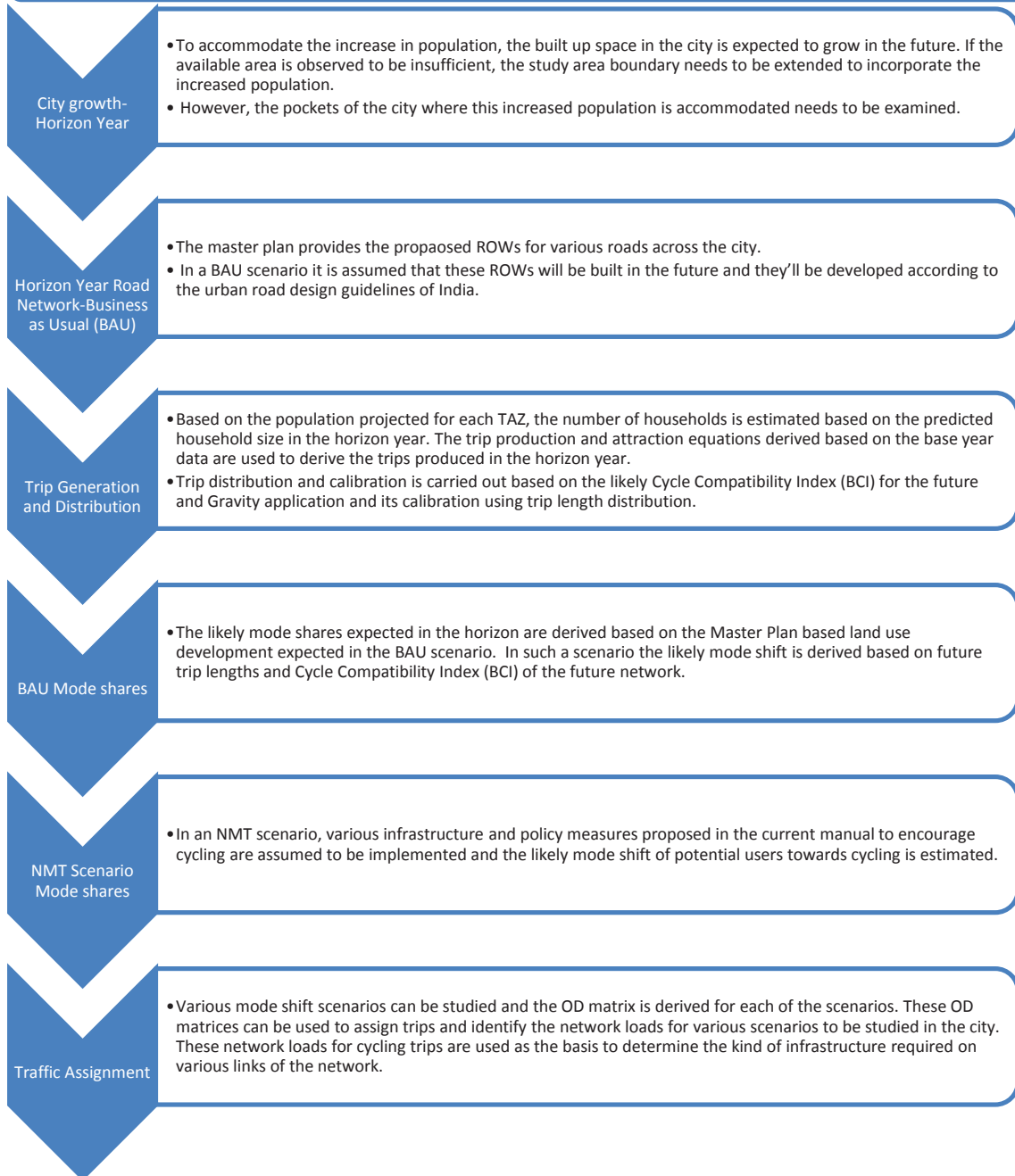

Figure 14 : Steps carried out for Horizon year scenario analysis

2.6 The Non-Motorized Transport Master Plan (NMT-MP) and Network Plan

The NMT master plan is a detailed document, which should include the study of all existing NMT routes in the city with current peak and off peak demand. Generally, these routes are from origin to destination and in the context of the Indian subcontinent, they cover almost the entire road network of any city. This is attributed to the nature of walk and cycle trips that are primarily work trips from low-income localities, to industrial areas (in case of industrial workers); local shops, commercial complexes and offices (in case of attendants, peons, runners, etc.); high and middle-income residential localities (in case of domestic helps, drivers, gardeners, guards, etc.) and local streets (in case of vendors, salesman, postman, courier delivery, repair and maintenance personnel, etc.). Other NMT trips that cover all parts of the city include good delivery on goods rickshaws and feeder as well short commuter trips on passenger rickshaws. Goods delivery trips are amongst the longest in the city as they offer city-wide connection between wholesalers, retailers and consumers.

The NMTMP should set the goals and desired level of service for NMT friendly infrastructure and include quantifiable criteria such as average cycling speeds, capacity (at a desired level of service – LOS), PBS and parking infrastructure (frequency and capacity along the route), integration options with public transport (parking infrastructure, fare concessions, feeder infrastructure,) etc. The main components of NMTMP are:

- Vision and objectives of the document along with details on the desired ‘Level of Service’ or LOS for the NMT infrastructure.
- Current data and understanding of NMT in the city along with related issues.
- Details and data on the current popular and potential routes, parking spaces.
- Suggested Network Plan
- Implementation Strategy
- Assessment Methodologies
- Institutional and policy requirements, etc.

The NMTMP should not be treated as an isolated set of recommendations for NMT friendly infrastructure development. It should be an empowered, legal document in line with the government’s policies on promoting non-motorized transport in the city. To enable this, the NMTMP or its key elements should be derived from the CMP which should be embedded or made a part of the master plan/ town planning schemes document, which once notified in the Gazette, is a legal document. This ensures that any deviation from the plan then becomes non-conforming and therefore illegal. This will not only label it as a legal, technical document to be adopted by all government organizations but also ensure policy based co-ordination within departments, especially since the NMT links and routes cross municipal borders. Figure 15 gives the steps involved in making a Non-motorized transport plan.

2.6.1 Phasing for NMTMP Implementation

After the design and planning intervention and developing scenario, the next step that is required is to phase intervention according to the priority in order to attain various defined objectives.

It is rarely possible to take up large-scale citywide development at one go. Thus, development of a citywide NMT specific infrastructure as per the network plan would require a phased expansion spread over time. While prioritizing development of routes or links in the network, captive routes should be prioritized over potential routes in line with the recommendations of NMTMP. Captive routes have high existing demand, which is declining due to unsafe conditions. Provision of infrastructure on these routes would not only help arrest their decline by ensuring safety, but also attract potential users.

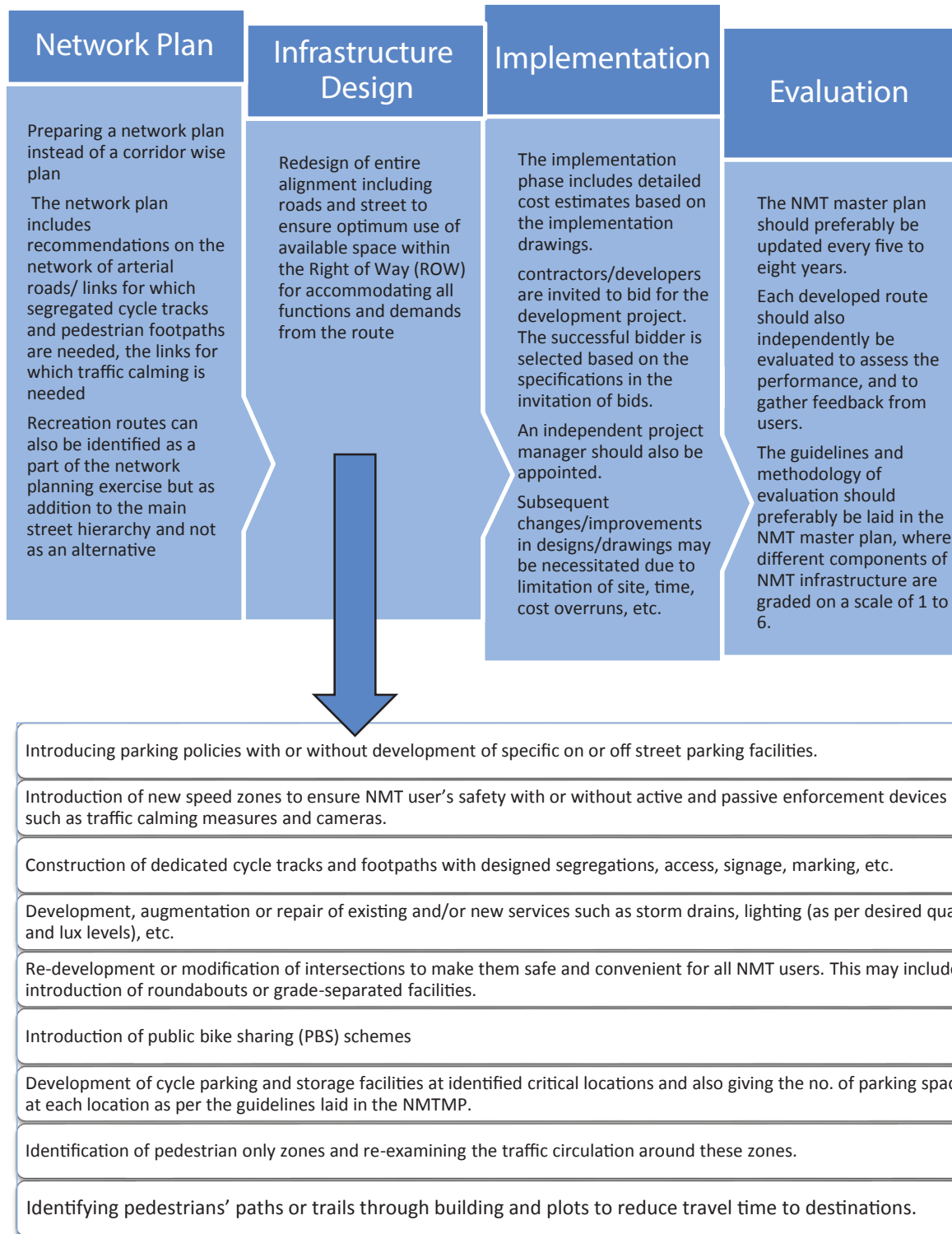

Figure 15 : Steps involved in making of NMT master Plan

The analysis to arrive at a phased plan may be based on the following criterion:

- Accident data – Routes with highest observed risk of accidents may be prioritized over others to ensure immediate reduction in fatalities. These would generally comprise fast and high traffic volume roads and thus most arterial roads within the city would fall under this category.
- NMT traffic volume – Routes with highest peak hour or daily demands may be prioritized over others to ensure wider impact.
- Ease of Construction and Maintenance – Routes along roads/streets with less obstructions/complications; or those within the same municipality limit as well under the same development body; or roads which are new developments or proposed to be re-developed with a sanctioned budget which includes provision for NMT infrastructure. This criterion may be selected as a standalone option only to demonstrate an infrastructure, though the same may have little impact on the NMT use.
- Contribution to the network – This becomes one of the most important criterions in selection of subsequent routes/links for development. After selecting the first route based on the three criterions discussed above, subsequent routes or links are selected to strengthen or contribute to a network. So connecting routes, or routes in the vicinity (with high demand and accident rates) are selected.

Table 9 presents how a combination of criterion may be used to set the priorities of development. It is important to note that smaller links may also be included, either as independent routes or part of bigger routes in the selection process. These links are useful in strengthening the network, keeping detours to a minimum, reducing the number of encounters with motorized traffic, and creating a cohesive network structure.

2.7 Network Planning in Existing Built-up Areas and New Cities

Due to the absence of any dedicated NMT infrastructure, cyclists and other NMTs in our cities have always used the road infrastructure sharing the carriageway with motor vehicles. However, with the growth of the city and the resultant increase in motorization, the street infrastructure developed into a strictly motor vehicle specific infrastructure and cyclists have been marginalized. All Indian cities are manifestations of this growth, evolving from traditional streets to urban roads and expressways. These cities therefore need to be retrofitted to incorporate the NMT planning concepts introduced in this chapter. This involves re-classification of the existing road network in these cities and planning for NMT specific infrastructure for each class of roads. Table 10 describes each of these categories as per their associated function, as well as their approximate Right Of Way (ROW) and design speeds. Also to strengthen the NMT network, the planners should look out for missing links in the existing network. These may include forced detours caused by parks, reserved forests, railway lines, drains, rivers, etc. Where a possibility of providing a bridge or a stand-alone walking and cycling path exists in a safe environment, these missing links should be marked or identified as independent NMT paths in the network. Also, recreational routes specifically for NMT users can be planned for the city to encourage choice users. However, these can only be an add-on to the street network but not an alternative to that. All the measures adopted like re-classification of road categories and proposal for new links specifically for NMT need to be incorporated into the planning documents of the city like its Master Plan and the Comprehensive Mobility Plan.

New urban centers being proposed have the option of developing on the principles of more sustainable urban transport which promotes mixed land use and offers more direct links for pedestrians, cyclists and public transport over private motorized vehicles. This would mean that the city provides dedicated cycle and pedestrian infrastructure and also closes more and more of its interior areas to motorised modes. The overall planning, which reduces the dependence of private motorized vehicles within the city, coupled with a dense NMT network providing direct links between all origin and destination points should result in high walk and cycle use, lower emissions/pollution and fewer accidents.

Table 9 : Combination Criteria

CRITERION	POINTS				
	Route 1	Route 2	Route 3	Route 4	And so on...
Accidents (safety)					
(Rate on a scale of 1 to 20 for each route where 20 is highest priority or possibility of selection as per this criterion and 1 is the lowest)					
NMT Traffic Volume (efficiency)					
(Rate on a scale of 1 to 15 for each route where 15 is highest priority or possibility of selection as per this criterion and 1 is the lowest)					
Contribution to the Network					
(Rate on a scale of 1 to 10, for each route or link; where relative points are awarded to routes, such as 10 points to the route connecting directly between one or more existing or selected routes, 1 point for links or routes which are isolated or at considerable distance from routes already developed or selected for development)					
Ease of Construction and Maintenance (cost)					
(Rate on a scale of 1 to 5 for each route where 5 is highest priority or possibility of selection as per this criterion and 1 is the lowest)					
Total Points					
	Priorities for development may be based on the total points allotted to each route/corridor, with routes having higher points placed higher on the priority.				

Table 10 : Roads, re-categorized

S.No.	Road Category	ROW (m)	Speed Limit (Km/hr)	Function
1.	Arterial Roads	30-80	50	A combination of flow and distribution function, these roads are expected to carry high speed and high volume motorized traffic.
2.	Distributor Street	12-30m	30	These are streets feeding the traffic from access roads to Arterial roads. These streets are expected to carry moderate volume of vehicular traffic with relatively low speeds.
3.	Access Streets	6 to 15	15	Access to residences, commercial establishments, etc. These streets are expected to carry low volume vehicular traffic at very low speeds.

3 Design for Cycle Infrastructure

Design for cycle infrastructure includes understanding of aspects that contribute to making of cycle infrastructure for various road categories, space allocation required for different types of cycles and translating the design requirements through cross section design, materials, signs and markings, etc.

3.1 Basic Information

The section provides the user with the basic dimensions of NMV and should be useful to understand the requirement by the vehicle and therefore develop cross sections, layout plans and design details for bicycle friendly infrastructure. As mentioned in Chapter 1, the shortcomings in the IRC Codes have been updated and cycle specific details have been included.

Vehicle Dimensions: Table 11 shows the basic dimensions of the following NMV:

Cycle: Bicycles are commonly used to carry gas cylinders, milk cans, etc. It is also commonly used for vending, and used for services such as post-delivery, telephone repair, garbage collection, etc. The bicycle is also used as a retail platform to display and sell products, like toys, cooked food, tobacco products, etc. (Figure 16)

Cycle Rickshaw: The cycle rickshaw is predominantly used as the main vehicle for commuting (mainly in small and medium sized cities) since the trips are short. (Figure 17)

Goods Rickshaw: A rickshaw is also used to transport goods to and from commercial shops. It is clear that even though in cities there are no visible passenger cycle rickshaws, goods rickshaws are predominantly used for freight transport. (Figure 17)

Tricycle for the differently abled: These are used by many physically challenged and mobility impaired people for commuting as well as used as mobile telephone kiosks/ eateries and serve as good livelihood options for persons with loco motor impairments (Agarwal & Chakravarti, 2014) . (Figure 18)

The rickshaw needs to be the limiting design vehicle for the NMT infrastructure. A comparison between the cycle-rickshaw and the bicycle has been discussed in the annexure.

Speed Design: The average speed range of NMT is about 5km/hr – 15 km/hr depending on the type of cycle users ranging from hand driven cart used by hawkers to bicycles and rickshaws. In rare cases, it can be higher than 20km/hr. It is important for cyclists to gain a cruising speed for constant usage. Interruptions due to parking, side roads and access to properties affect the desirable speed and make it difficult for the cyclist. Hence, variations in alignment, levels and form of the bicycle infrastructure should be avoided. Vertical Gradients need to be well accommodated.

Clearances and Widths: The width requirement for a NMV in movement is higher than its physical dimensions. This is on account of two main factors: zigzagging movement (side to side movement to maintain balance during riding) and fear of obstacles (or maintenance of manoeuvring gap). Bicyclists carrying goods and pillion riders may experience higher zigzagging on account of the extra weight carried, while cycle rickshaws experience minimal or no zigzagging. The distance that NMV maintain for fear of obstacles depends on the height of the obstacle. Figure19 shows us the variations in width and clearances from different obstacles.

Turning Radius: Bends are required for smooth connections between cycling paths and also to ensure continuity of the infrastructure. The radius of curves used in bending a path affects the speed of NMVs using it. The sharper the bend, lower the speed. Minimum design speed for stability requirement of a bicyclist is 12 km/hr. Bends of 30m radius or more are preferred on segregated bicycle tracks to maintain visual directness and continuity of the path and also to reduce the path widening requirement due to additional width requirement for a rider negotiating bends. It is also evident that turning radius of less than 10m should not be considered as it does not permit cycling at comfortable cruising speeds. (Figure20)

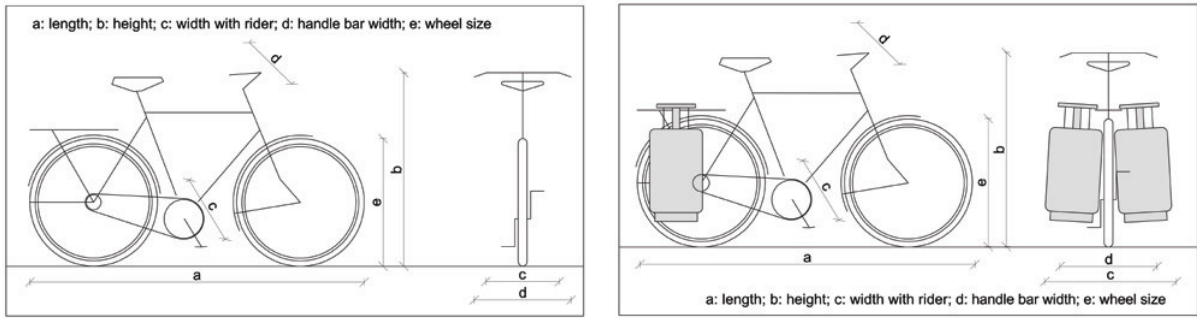

Figure 16 : Basic Information - Bicycle

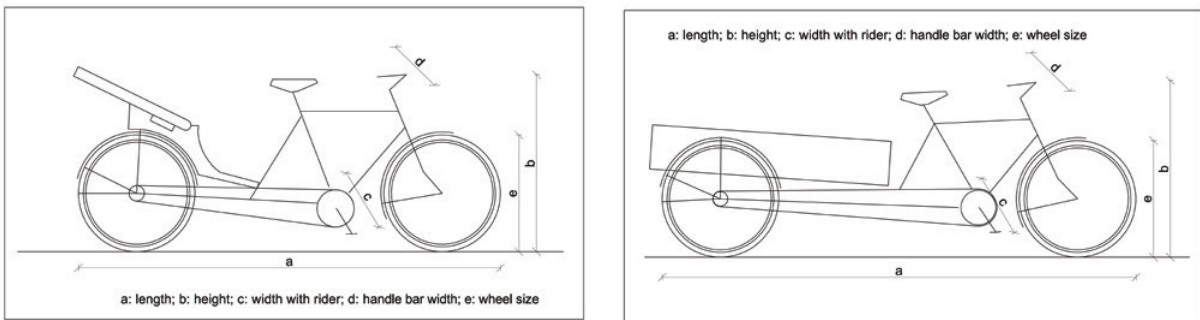

Figure 17 : Rickshaw – passenger (L) goods (R)

Table 11 : Vehicle Dimensions

	a Length (mm)	b Height (mm)	c Width with rider (mm)	d Handle bar width (mm)	e Wheel size (dia. in mm)
Adult Touring Bike	1950	1200	750	600	710
Adult Touring Bike with goods (milk cans or gas cylinders)	1950	1200	950	600	710
Passenger Rickshaw	2200	1200	1000	600	710
Goods Rickshaw	2400	1200	1220	600	710
Modified goods rickshaw	2600	1200	1400	600	710



Overall Length : 2000 mm
 Overall Width : 860 mm
 Overall Height : 1000 mm
 Weight : 35 Kgs. (approx.)



Overall Length : 1815 mm
 Overall Width : 750 mm
 Weight : 26 Kgs. (approx.)



Overall Length : 1600 ± 50 mm
 Overall Width : 745 ± 25 mm
 Overall Height : 850 ± 25 mm

Figure 18: Tricycle for the differently-abled. Source: ALIMCO : Tricycle

Riding on Bends: A safe leaning angle for a cyclist while negotiating a bend at a co-efficient of friction of 0.3, is about 18° from the vertical or 72° from the horizontal plane. A widening of about 0.51m per lane is required to accommodate the extra width on account of this bending. At cruising speed, widening of cycle lanes become necessary for all turning radiuses less than 120m (when the lean angle is negligible and widening requirement falls to less than 0.05m per lane).

Inclines and Slopes: While designing infrastructure for the cyclists, horizontal/ vertical / super elevation are of minor consideration. Only vertical gradients are applicable. The most desirable condition is to avoid level changes or introduction of any inclines along NMV infrastructure. In some conditions, negotiating a bridge or a tunnel may be unavoidable for a cyclist. These can be a nuisance especially rickshaws and cyclists carrying goods or passengers. It is very important to make the ground level more cycle friendly than expecting the cyclists to detour from their natural path. Table 12 indicates the recommended slope gradient.

Table 12 : Inclines and slopes

Level to be negotiated	Recommended Incline/Slope	
1m	1:12 - 1:20	
2m	1:30 – 1:50	
5m	1:30 – 1:50	Resting place of 25m length to be incorporated as a horizontal section
Rail Over Bridge	1:40 – 1:60	

On a decline, junctions and obstructions should be spaced reasonably far from the bottom of the incline because cyclists (especially those carrying a load) need plenty of free space at the bottom of the incline to recover from the speed.

3.2 Design Requirements

The five main requirements for design - Coherence, Directness, Attractiveness, Safety and Security and Comfort are explained as follows:

Coherence - Coherence relates to the legibility and connectivity of the bicycle network. In design, this implies that the segments in the network should look similar to improve the legibility and usability of the bicycle infrastructure and there is provision of good connectivity between all origins and destinations. Constant width ensured through design with adequate widening at turns and rendering the same texture for typical scenarios across the network would help not only the cyclists to identify with it but also ensure that motorists are cautious at trouble prone locations. Elimination of any missing links as well as standardization of intersections i.e. the shape, size and form of each category of junction solution should be similar to help the cyclist be aware of vehicular behavior in the traffic mix. Also, use of various measures like marking, signs and traffic calming measures across intersections improves coherence.

Directness- Directness of bicycle infrastructure has to do with the amount of time and effort required by a cyclist to undertake a journey. Therefore, major detours from their natural path should be avoided. As mentioned in the ‘Design manual for bicycle traffic’ (CROW, June 2007), directness has two components: in terms of distance and time. At intersections, directness in time may be achieved by eliminating stopping/waiting for cyclists by introducing bicycle specific grade separated infrastructure, defining the cyclists right of way and signals which eliminate or reduce staged crossing and delays. Directness in distance for NMV users can be achieved by eliminating any detours or long bends for cyclists at intersections, and by reducing or eliminating stages in a crossing.

Attractiveness - To ensure attractiveness, care should be taken that the path of the cyclist should be clean and devoid of any dumped material that blocks movement. Such a blockage would prevent the cyclist from using the cycle infrastructure from the initial point and force him to use the carriageway in unsafe conditions. Location of spaces for hawkers and vendors, well integrated bus shelters, green areas, resting spaces, etc. and shaded NMT infrastructure are factors that are definitely attractive.

Safety and Security – Prevention of collisions and reducing the conflicts and their impact will result in a safer travel. Provision of adequate and uniform lighting ensures enhanced usability as well as safer streets.

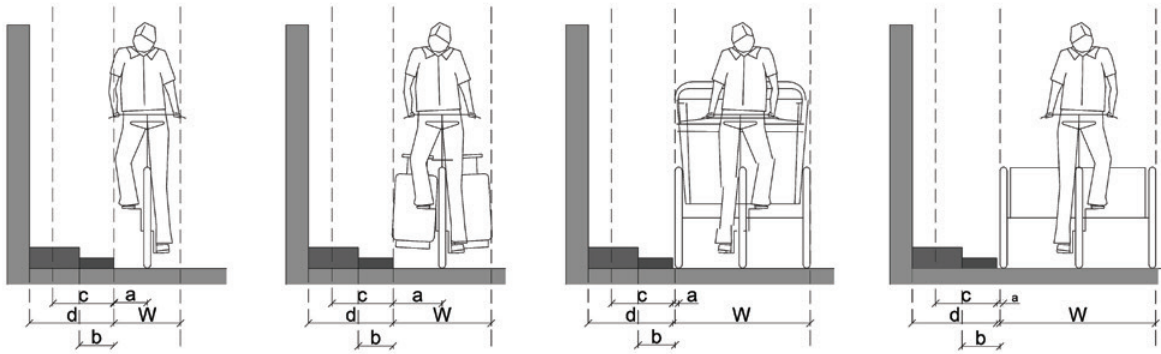

	Total Width (as per cycle type)	Total clearance from obstacles 0-50 mm	Total clearance from obstacles 50-150 mm	Total clearance from obstacles regarding fixed objects like poles & bollards in mm	Total clearance from fear of obstacles regarding closed walls (from body edge) in mm
	W	a	b	c	d
Adult Touring Bike	750	0	125	325	625
Adult Touring Bike with goods (milk cans or gas cylinders)	950	0	325	325	625
Passenger Rickshaw	1000	250	325	325	625
Goods Rickshaw	1220	250	325	325	625
Modified goods rickshaw	1400	250	325	325	625

Figure19 : Clearances and widths

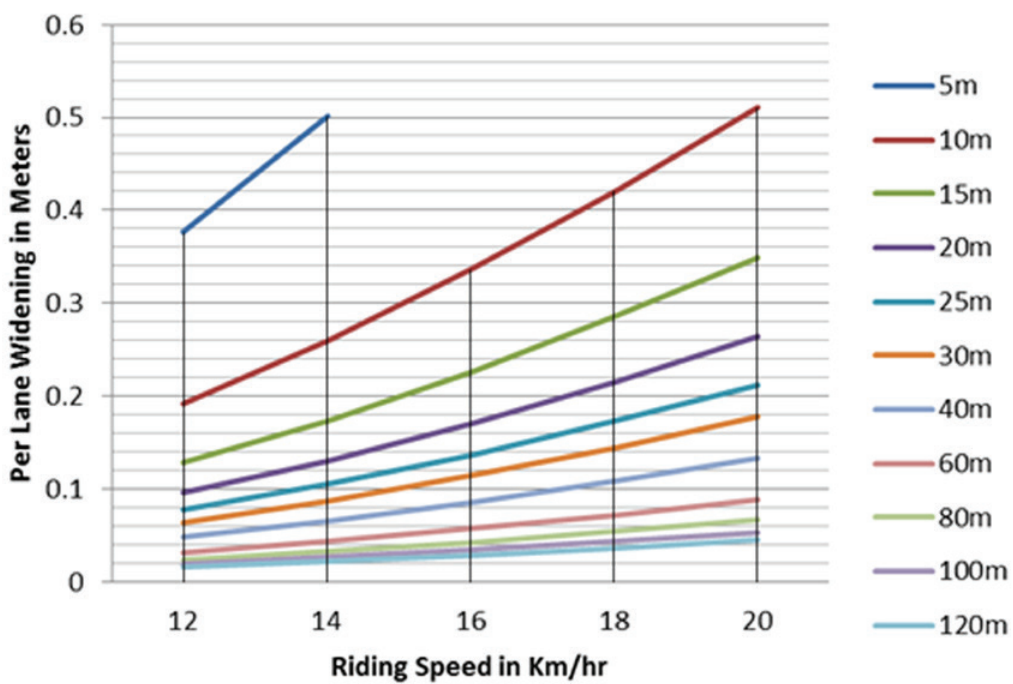

Figure20 : Per cycle lane widening required at bends based on riding speed and turning radius

Integration of spaces for hawkers and vendors, support facilities provides security and the necessary eyes on street. Safer Intersections can be provided by minimizing conflicts (and sub-conflicts), introducing traffic calming and resolving complexity by eliminating segregated left turning lanes, etc.

Comfort - Riding comfort is essential to bicycle infrastructure therefore the surface should be even and free of cracks and potholes. Riding surface for cyclists at the intersection should be smooth to reduce inconvenience. Water logging in the path of cyclist areas is uncomfortable and therefore it is important that proper drainage should be provided with regular maintenance. Also at intersections, traffic nuisances should be minimum. Segregation terminating up to the stop line at high speed roads or high volume distributor and access roads will ensure cyclists that their Right Of Way (ROW) is not obstructed by vehicular traffic.

3.3 Data Collection

Site data and traffic counts are required to produce a cycling inclusive and balanced, road re-development plan. The necessary surveys are:

Geometric Survey - A total station based geometric survey of the entire ROW along the length of the road is a basic requirement to start a cycling inclusive corridor design. A total station survey will give complete topographical data of existing underground and overhead features like services and utilities, the existing landscape, buildings and structures. The accuracy of the survey is important; therefore it is advisable to pick points every 10m along bends and every 20m on straight portion of the roads. The survey drawing should be globally aligned using global positioning system (GPS) based co-ordinates, and the control/benchmark points should be physically recorded on site with care on durable cement concrete benchmark pillars so that it can be effectively used for accurate layout of computerized drawings on site.

Activity Survey - An activity survey allows an understanding of the user requirements and behaviour, which cannot be reflected by a geometric survey. It records dynamic, formal and informal activities at the site, such as parking, hawking, service activities, etc. This presents an opportunity for integrated planning to address these requirements, which otherwise have a potential of compromising planned usage of the corridors. All activities are marked physically, on the survey drawings, as per appropriate symbol and size indicating the quantity and spread accurately, in order to produce a plan image of the current usage. Figure 21

Traffic, Parking and Accident Surveys- Traffic surveys provide an assessment of current vehicular (motorized and non-motorized) as well pedestrian traffic demand on the corridor. The road infrastructure planning should address peak volumes, hence daily or 16 hour surveys are required to derive peak hour data. Longer survey duration for traffic counts is also important because non-motorized and motorized modes have generally staggered peak hours. Parking surveys record the current usage of land at different times of the day by parking—both formal and informal.

A detailed sample sheet for all of the above mentioned surveys in the annexure.

3.4 Infrastructure Design

An efficient urban road network follows a hierarchy. The hierarchy is based on the function that the road is expected to perform, and the type of traffic and the road users present on the road. The design speeds, road widths and other geometric features are adapted to suit the road function. The Code of Practice-1 describes the road typologies and its components in detail. (MoUD, 2012). Table 13 shows the road hierarchy as well as the speed limit for each.

3.4.1 Cross Section Design

The street selected for planning is divided into various segments based on its function, form and use from the surveys mentioned earlier. The minimum and most available ROW conditions are selected for each stretch from the total station survey drawing, for the development of the cross section designs. The main elements of a cross section design are given in Table 14.

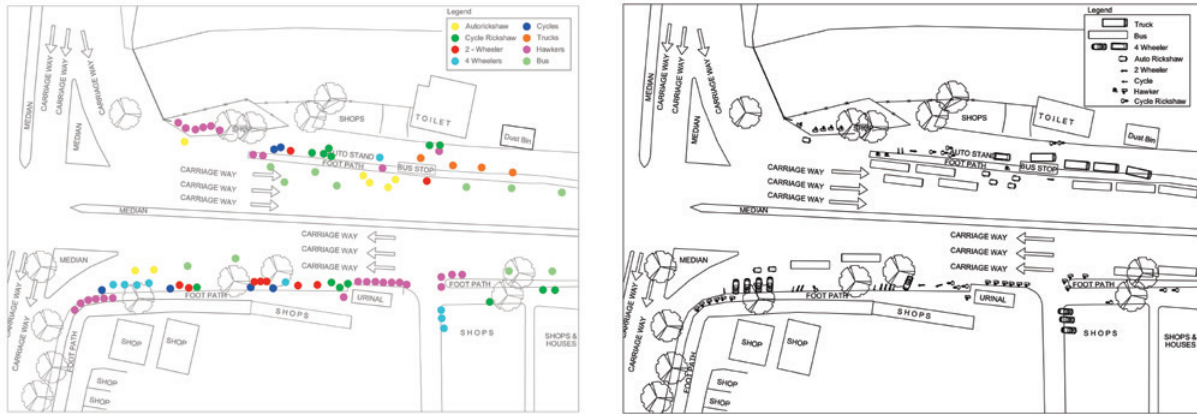

Figure 21 : Activity Survey done on geometric survey at site and then transferred on a digital base. Source: TRIPP, IIT Delhi

Table 13: Road Typology

Road Typology	Right of Way-ROW (m)	Design speed (km/hr)
Arterial Roads	50-80	50
Sub Arterial Roads	30-50	50
Distributor/Collector Roads	12 - 30	30
Access Streets	6 - 15	15

Table 14 : Cross Section Design Elements

	Arterial Roads	Sub Arterial Roads	Distributory Roads	Access Roads
Carriageway				
Criteria	50 km/h	50 km/h	<=30km/hr	<= 15 km/hr
ROW	50m – 80m	30m – 50m	12m – 30m	6m – 15m
Gradient	2%	2%		
Number of lanes	Maximum 6 to 8 lanes divided (using a raised median);	Maximum 4 to 6 lanes divided (using a raised median);	Maximum 4 lanes of 3.0m width each (excluding marking) or 2 lanes of 2.75m to 3.1m width each (excluding marking) with or without an intermittent median	1 to 2 lanes, (undivided); of 2.75 to 3.0m width each
Maximum Width for car lane	3.0 to 3.3m width each (excluding lane marking)	3.0 to 3.3m width each(excluding lane marking)	3.1m width each	2.75 to 3.0m width each
Maximum Width for bus lane / Mixed lane	3.3m - 3.5m			
(segregated) excluding lane marking	3.3m - 3.5m (segregated) excluding lane marking or painted lane	Mixed traffic		
	Mixed			
Levels	0.0m	0.0m	0.0m	0.0m

Note - In special cases, there are conditions on arterial and sub arterial streets where the ROW gets constricted to a minimum of 24m. In such conditions, the continuity of the NMT and pedestrian infrastructure is important without creating a bottle neck in the arterial/sub arterial flow. A segregated cycle track and footpath can be easily achieved with 2 lanes in both directions.

	Arterial Roads	Sub Arterial Roads	Distributory Roads	Access Roads
Non Motorised Vehicle	Segregated Cycle Track	Segregated Cycle Track	Cycle Lane	Mixed \traffic
Location	Between Carriageway or street parking and footpath on either edge of the carriageway	Between Carriageway or street parking and footpath on either edge of the carriageway	On the edge of the carriageway, adjacent to the footpath or parking.	
Gradient	1:12 – 1:20 (min)	1:12 – 1:20 (min)	1:12 – 1:20 (min)	1:12 – 1:20 (min)

Desirable Lane width	2.5 to 5.0m	2.5 to 5.0m	1.5 to 2.5m	Mixed with motorized vehicular traffic
Level	+50mm to +100mm	+50mm to +100mm	0.0m	0.0m
Minimum Width	2.2 for a two lane cycle track and 3m to 4m for a common cycle track and footpath (not more than a length of 40m).	2.2 for a two lane cycle track and 3m to 4m for a common cycle track and footpath (not more than a length of 40m).	1.2m painted cycle lane.	Mixed condition
* To be applied on both directions of ROW for streets which have uni-direction vehicular traffic				
	Arterial Roads	Sub Arterial Roads	Distributor Roads	Access Roads
Pedestrian Paths				
Gradient	1:20	1:20	1:20	1:20
Level	+150mm	+150mm	+150mm	0.0m
Lane width	2.5m (including curbs) to 5.5m each side. However where secondary footpaths are available along service lane, the minimum width of secondary paths can be 1.5m minimum(including curbs) *Based on site observation, if required, the secondary/ side footpaths could equal or larger than the primary path	2.5m (including curbs) to 5m each side.	2.5m (including curbs) each side.	0-2.5m (including curbs) each side.
Minimum Width	1.8m	1.8m	1.8m	1.8m
* To be applied on both directions of ROW for streets which have uni-direction vehicular traffic				

Green Belt/Utility Belt				
Width	0.75m (min) desirable = 1.5m			
Location	Primarily between carriageway and cycle track. Secondary between cycle track and pedestrian path. In addition tree planters may be provided between parking bays on the service lane.	preferably located between cycle lane and pedestrian path	preferably located between carriageway and pedestrian path	
	*Tree belt should be provided 0.025 to 0.05 m lower than adjoining paved surface to avoid discharge of excess rainwater collected.			
Parking				
Width	Parking width can vary from 2.5m (parallel parking) to 5.0m (perpendicular parking) along with adequate width of access road.	1.8 to 2.5m width (parallel parking)	Non defined, mixed function with motorized vehicular traffic	
Location	Service lane only	Service lane only	Along carriageway between cycle lane and footpath	preferably be located between carriageway and pedestrian path
Levels	0.0m	0.0m	0.0m	0.0m

Median - The divider between the two way traffic lane is called a median. In urban areas, medians are often used as a pedestrian refuge for arterial roads. Pedestrians can use medians as narrow as 1.2 m but the preferable width is 2 m where space permits. Distributor roads are usually divided using paint marking. There is no physical segregation required. Design of Urban Roads, Code of Practise -1, includes ready reckoner’s as well as diagrams suitable to be used for various ROW conditions.

Figure 22 shows a cross section design for various road categories for two way streets. In case of roads carrying uni-direction carriageway traffic, it is important to apply the edge conditions mentioned for various road types similar to that of two way streets. Therefore, each arterial street will have a segregated cycle track and pedestrian path on both sides of the carriageway.

In the case of a cross section design at the junction, the bicycle track/lane alignment follows the widening alignment of the carriageway, which provides a convenient turning radius at bicycling speeds. Little or no modifications are required or desired with respect to location, size, form and function of the bicycle track at the intersection (from that at the mid-block). Any limitations or restrictions within the ROW have to be solved in the interest of the cyclists. This has been discussed in section 3.4.3.

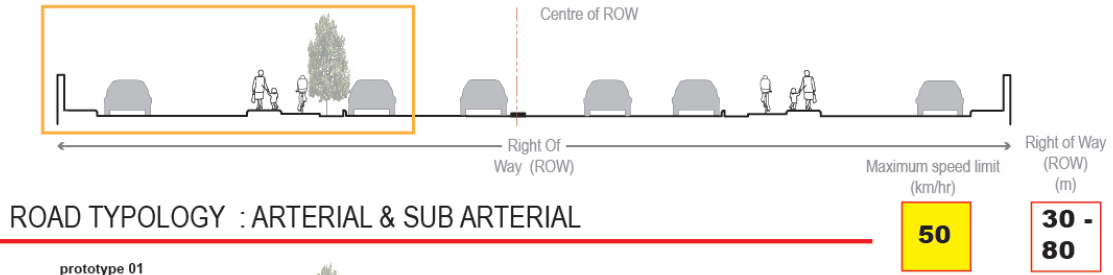

ROAD TYPOLOGY : ARTERIAL & SUB ARTERIAL

prototype 01



NOTE : Plantation of tree only when service belt width of width 1500mm

prototype 03

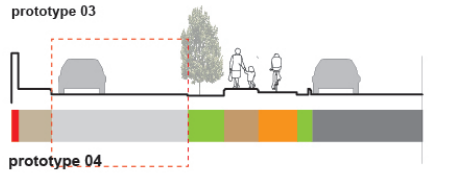

prototype 04

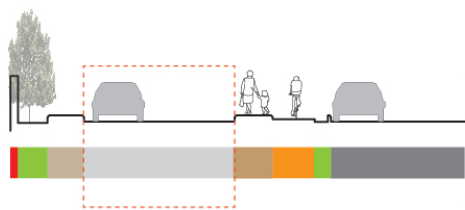

prototype 02



prototype 05

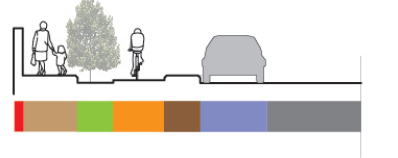

ROAD TYPOLOGY : DISTRIBUTOR

prototype 01



NOTE : Plantation of tree only when service belt width of width 1500mm

prototype 02



NOTE : Plantation of tree only when service belt width of width 1500mm

prototype 03



ROAD TYPOLOGY : ACCESS

prototype 01

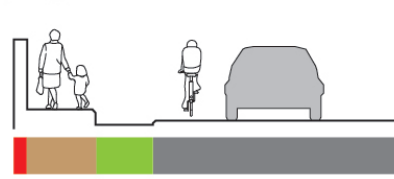

prototype 02

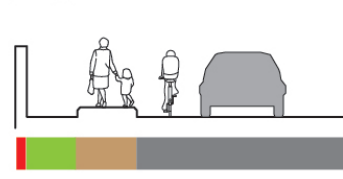

prototype 03

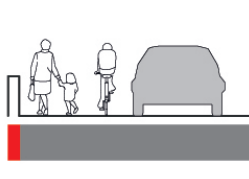

LEGEND

- EDGE OF ROW
- CARRIAGEWAY
minimum 2 lanes each direction
divided by a median
- CYCLE LANE
Desirable Width : 1500mm
- CYCLE TRACK
Desirable Width : 2500mm
Height: 50mm - 100mm
- BOARDING BAY
Width : 750 mm (min) ;
Height: 150mm (maximum)
- SERVICE BELT
- SERVICE LANE/ PARKING
Width : 2m (minimum)
- TREE BELT / SWALE
Width : 1500mm (desirable)
Chamber to drain
- FOOTPATH
Width : 1800mm (min)
Height: 150mm
- FOOTPATH (SIDE)
Width : 1800mm (minimum)
Height: 150mm
- PARKING BAY
Based on the available width the parking can be both directions in parallel,
perpendicular and angular configurations.
- PARKING BAY
Constricted arterial roads do not have adequate width for a service lane.
Therefore, provision of parallel parking (intermittent) along carriageway.

Figure 22: Cross Section Design – Prototype for various roads

3.4.2 Intersection and Approach design

The intersection design forms an integrated part of the overall route for a NMV user. As mentioned in the design requirements, all principles need to be applied in intersections as well. Based on the types of roads intersecting, junctions can be classified as a signalized intersection, an un-signalized intersection or a roundabout. Traffic lights are a less (sustainably) safe solution than geometrically designed roundabouts or grade separated intersections and must therefore be regarded as second best in terms of safety (CROW, June 2007). Intersections created within and between each road type presents varying challenges to directness, safety, comfort and the attractiveness of NMV infrastructure. A detailed description of design and geometry of each typology has been discussed in Code of Practice -2 (IUT, 2012). Table 15 presents the grading of these intersection types based on the severity of conflicts with cyclists/NMVs (1 being highest, and 6 being the lowest severity) based on the expected speeds and volumes of motorized vehicles. Cyclists choose to cross along with vehicular traffic or along with pedestrian traffic or independent of vehicular and pedestrian traffic. Some known advantages and disadvantages of each approach are indicated in Table 16. Table 17 shows a comprehensive chart of various possible solutions. Detailed designs of these solutions should include geometric elements based not only on the type of junction but on requirements of directness, safety and comfort as well selected crossing method for cyclists.

Table 15: Intersection type vs. Severity

	Arterial Roads	Distributor Roads	Access Streets
Arterial Roads	1	2	4
Distributor Roads	2	3	5
Access Streets	4	5	6

Type of Severity (Most Severe 1>>>2>>>3>>>4>>>5>>>6 Least Severe)

Table 16 : Advantages and Disadvantages of each approach of crossing bicyclists

Bicyclists crossing along with or as vehicular traffic	Bicyclists crossing along with or as pedestrian traffic	Bicyclists crossing independent of vehicular and/or pedestrian traffic
Direct route across the intersection; At busy intersections with high speeds potentially very dangerous.	Usually very uncomfortable and indirect; Inducing conflicts between cyclists and pedestrians; Denial of vehicular characteristics of cycling. This solution is often chosen by lack of other feasible options.	Intersection design can contribute to clearer position of cyclists; Conflict points can be identified and thus conflicts can be managed; Usually these intersections will be more complicated and more spacious.

Roundabouts: Safety of cyclists and pedestrians negotiating a roundabout can be ensured by reduced vehicular speeds and geometric designs, ensuring adequate segregation and visibility for slow moving users. Modern roundabouts allow better capacity without compromising safety. However it is important to understand that roundabouts have capacity limitations. Geometric elements of a roundabout and the methodology of its geometric design have been explained in Code of Practice -2 (IUT, 2012).

Signalized Junctions: At signalised intersections, expected delays for cyclists are considerably longer than other junction solutions. Therefore, a flexible approach to adapt a single or combination of crossing methods should be adopted. A designer may use one of the following design tools for signal and intersection geometry to be able to address NMV requirements without significantly compromising the needs of motor vehicles. In a signalized intersection, the following is of importance:

Segregation at or Near Intersection ensures safety and directness for cyclists. Cycle tracks extending up to the stop line on the near side of the junction ensures reduced delays, higher safety and protection from motorised traffic. Designated bicycle facilities (tracks or lanes) on both sides of the junction provide a comfortable and direct path for NMV users.

Bicycle Boxes or Waiting Spaces for cyclists (Figure 23) are required for waiting cyclists on the near side of junctions. Bicycle holding area or boxes and signal phase design are inter-related to the flow of bicyclists and

Table 17: Intersection Solutions

	Arterial Roads	Distributor Roads	Access Streets
Arterial Roads	<ul style="list-style-type: none"> Roundabouts (3,4 arm) Signalized Crossings (3,4 arm) Grade separated crossing for motor vehicles Grade Separated Crossings for cyclists, along Arterial road (in case of 4 arm only) 	<ul style="list-style-type: none"> Roundabouts (3,4 arm) Signalized Crossings (3,4 arm) Grade Separated Crossing for cyclists along Distributor road (4 arm only) 	<ul style="list-style-type: none"> Traffic calmed crossing (3 arm only – access street opening on to an arterial road) Grade Separated Crossing for cyclists along access road
Distributor Roads	<ul style="list-style-type: none"> Roundabouts Signalized Crossings (3,4 arm) Grade Separated Crossing for cyclists along Distributor road (4 arm only) 	<ul style="list-style-type: none"> Roundabouts Signalized crossing 	<ul style="list-style-type: none"> Roundabout Un-signalized/ Traffic Calmed Crossing (3, 4 arm)
Access Streets	<ul style="list-style-type: none"> Traffic calmed crossing (3 arm only – access street opening on to an arterial road) Grade Separated Crossing for cyclists along access road 	<ul style="list-style-type: none"> Roundabout (3, 4 arm) Un-signalized/ Traffic Calmed Crossing (3, 4 arm) 	<ul style="list-style-type: none"> Un-signalized/ Traffic Calmed Crossing (3, 4 arm) Mini Roundabouts



Bicycle box at BRT Corridor, Delhi



Intersection crossing path for cyclists at Roundabout
(Source:www.standard.co.uk)

Figure 23 : Crossing Methods at Intersection. Source: SGArchitects(L), www.standard.co.uk(R)



Figure 24: Figure 24: Grade Separated Crossing for NMV (ongoing construction), Chandigarh

motorized vehicles; and need to be looked at together. However, it should be clear at all junctions, especially those on arterial. NMVs flexibility in crossing along with vehicles is required to reduce delays. This cannot be facilitated without providing areas for waiting ahead of vehicular queues. NMVs accessing bicycle boxes or waiting space should be provided with a clear, defined and barrier free path. At locations, where the bicycle track does not open directly onto the cycle box, a surface coloured and pavement marked bicycle lane (with bicycle symbols) should be provided as a direct connection between the two. This has been discussed in section 3.5.6.

It is important to check the proposed signal plan for bicycle compatibility. Currently, signal engineers tend to exclude NMV requirements from design considerations leading to inefficient and unsafe designs for cyclists. Designers should ensure inclusion of specific NMV considerations in the signal design. A separate signal phase is not required.

Provision of Left turning Traffic: To cater to left turning motorised traffic, the following solutions are to be taken up in order of priority:

1. Ignore a segregated left turning lane: Additional turning pocket for left turning vehicles may be provided on the near side of the junction but a segregated lane should be avoided. The left turning traffic moves as per regular signal along with straight moving traffic.
2. Signalized and Traffic Calmed Segregated left Turning Lanes : At junctions where heavy left turning traffic is expected, signal engineers and traffic police may insist on provision of segregated left turning lanes to reduce any expected delays for motorized traffic. In such a scenario, the negative impacts of segregated turn lane can be reduced by introducing a two-phase pedestrian and bicycle signal coupled with traffic calming in the form of speed table or raised crossing for cyclists and pedestrians. Here speed tables are also an essential component to ensure continuity and coherence of bicycle infrastructure across segregated left turn vehicular lane. It must be clear however that this type of solution for cyclists and pedestrians is **always only second best**.

The advantages and disadvantages of each of the solutions have been discussed in the annexure 3.7.6.

SHOULD WE HAVE FREE LEFT TURNS?

Free segregated left turning vehicular lanes deny cyclists and pedestrians any safe time to cross the junction, and adds to their delays and risk. It is also known that in most cases signal free left turning lanes do not provide any significant benefit or relief to waiting motorists; on the contrary they cause friction and reduced flows for motorists merging after the junction. However, it can also reduce crossing distances in very large intersections.

Grade Separated Crossing: Grade separated infrastructure needs to address all requirements of both current and potential cyclists. In some situations, this approach may require provision of both, at grade and grade separated crossing facilities to address different requirement for various NMV users. Grade separation of intersecting motorized vehicle carriageway (flyovers, etc) is a high cost intersection design solution, which may be suitable for use on highways or expressways. Such solutions are not desirable within the built up areas or urban limits due to their adverse impact on accidents, pollution, etc. However, grade separation of cycle and pedestrian traffic across high-speed and high volume motorized vehicle carriageway may often be advisable to ensure safety of cyclists and pedestrians. Figure 24

Traffic Calmed and Un-signalized Junctions: For minor intersections, it is recommended to apply traffic calming such as mini roundabouts, humps, table tops to keep the speed of motor vehicles in check.

3.4.3 Special Conditions

While cross section and intersection designs provide location specific solutions, they cannot be used for implementation and development of a complete bicycle infrastructure along a corridor. A detailed plan showing the location, layout and alignment of all road elements on the corridor is required. This section discusses the layout and integration of situations and contexts referred to as special conditions in a plan and profile for implementation. To comply with the principles of bicycle infrastructure, the following should be

SPECIAL CONDITION : BUS SHELTER



Arterial / Sub Arterial Road

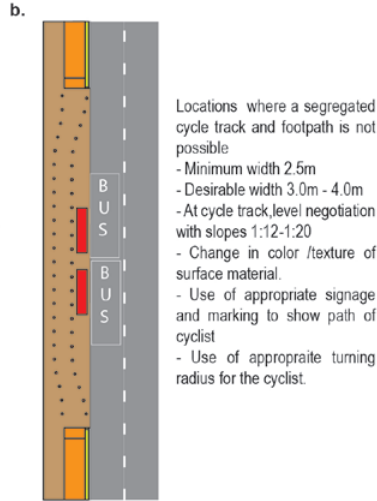
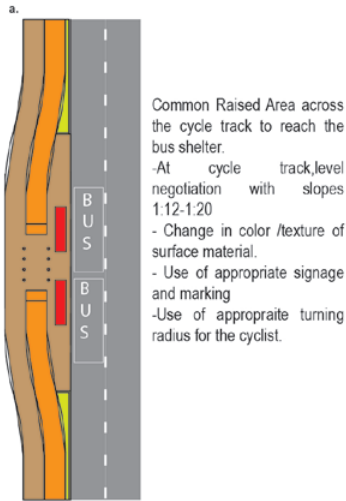

Distributory Road

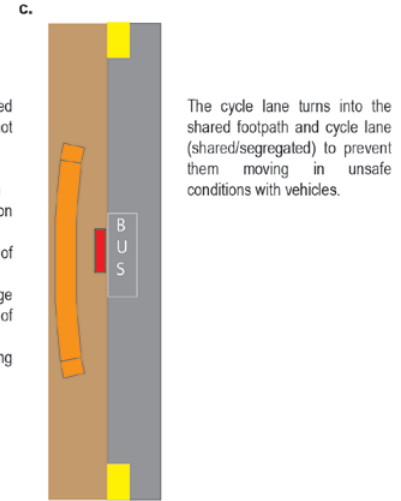

SPECIAL CONDITION : HAWKER SPACE

Arterial / Sub Arterial Road

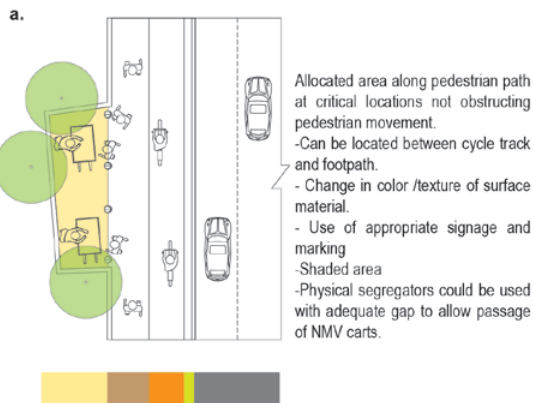

Distributory Road

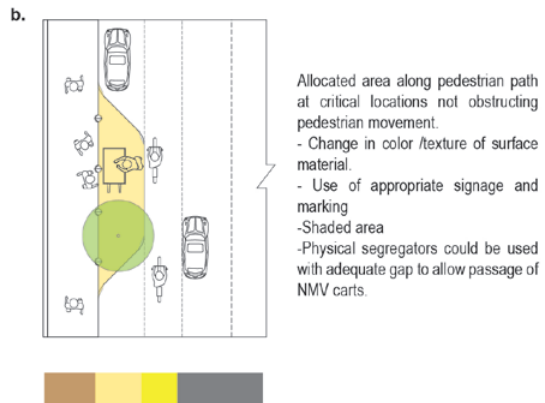

SPECIAL CONDITION : LIMITATIONS 40m - 200m

Arterial / Sub Arterial Road



LEGEND

BUS SHELTER	CARRIAGEWAY minimum 2 lanes each direction	CYCLE LANE Width : 1400mm	CYCLE TRACK min width : 2200mm	FOOTPATH minimum width : 1800mm
SERVICE BELT	TREE BELT / SWALE	HAWKER SPACE	TSR PARKING BAY	CYCLE RICKSHAW PARKING BAY

Figure 25 : Special Conditions: Bus Shelter (Top) Hawker Spaces (Center) Limitations between 40m – 200m (Bottom)

taken into consideration:

- Location of NMV/Bicycle Path/Lane in the Cross Section
- Width of bicycle path/lane
- Form of bicycle path/lane: Bicycle lanes require less width than segregated bicycle tracks. A designer may thus choose to introduce bicycle lanes for the length of a stretch where there is an existing track constrained by available space
- Function of bicycle path/lane : Compromises affecting the function of bicycle path/lane include combining or sharing of bicycle infrastructure with other users or functions such as pedestrian path in case of NMV/ Bicycle tracks and carriageway in case of NMV/Bicycle lanes. These compromises should only be made where continuous length of constriction/limitation is between 5 and 40m.

WHEN THERE IS NOT ENOUGH RIGHT OF WAY (ROW)?

Cycle tracks located beyond the pedestrian path should preferably not be continued for very long continuous distances. It is preferable that such lengths be no longer than 40 to 200m. In case the width reduction necessitates a width lower than the minimum prescribed for a particular ROW condition, it may be desirable to combine the pedestrian path and NMV lane. If the length of constriction is lesser than 40m but requires transition to cycle lane from cycle track for a length of less than 40m, the preferred solution here is to instead provide a combined width of 3.0m – 4.0m. At distributor streets, where there is high parking friction or the lanes on intersections get encroached by the volume of cars, provision of segregated tracks is recommended strongly. The changeover from bicycle track to cycle lane and vice versa should require little or no change in the direction of travel by the cyclists and both should form a part of one continuous alignment.

The predominant conditions seen in our urban roads are as follows:

1. Bus Shelters – When curb side shelters are installed on the road, it needs to be connected to the pedestrian path. Ideally, for a segregated cycle facility, one has to detour the cyclists from their natural path but for a short distance. (Figure 25)
2. Hawker Spaces – Presence of hawkers and street vendors provides security and services to road commuters. Allocation of a dedicated space shall also make the street more lively and interesting. (Figure 25)
3. Obstacles – Trees, encroachments etc. might create hindrance in the natural path of the cyclist. It is important to eliminate obstacles such as light poles, encroachments, etc. At places, where trees also lie in the path of the cyclist, for a short stretch, it is important to change the course of the cyclist with the proper turning radius and maintaining the required obstacle-free width. (Figure 25) (Figure 26)
4. Para Transit – TSR and Cycle rickshaw are feeder services and need to be integrated in the cross section as well as intersections at critical locations to enhance seamless multi-modal accessibility. (Figure 26)

Grade Separated facilities like flyovers are solutions specific to motorised traffic. Once constructed, it is seen that no special facilities are created at grade for cyclists and pedestrians. One needs to prioritize their movement at grade critically at these locations keeping in mind the 5 design requirements mentioned earlier.

SPECIAL CONDITION : LIMITATIONS upto 40m

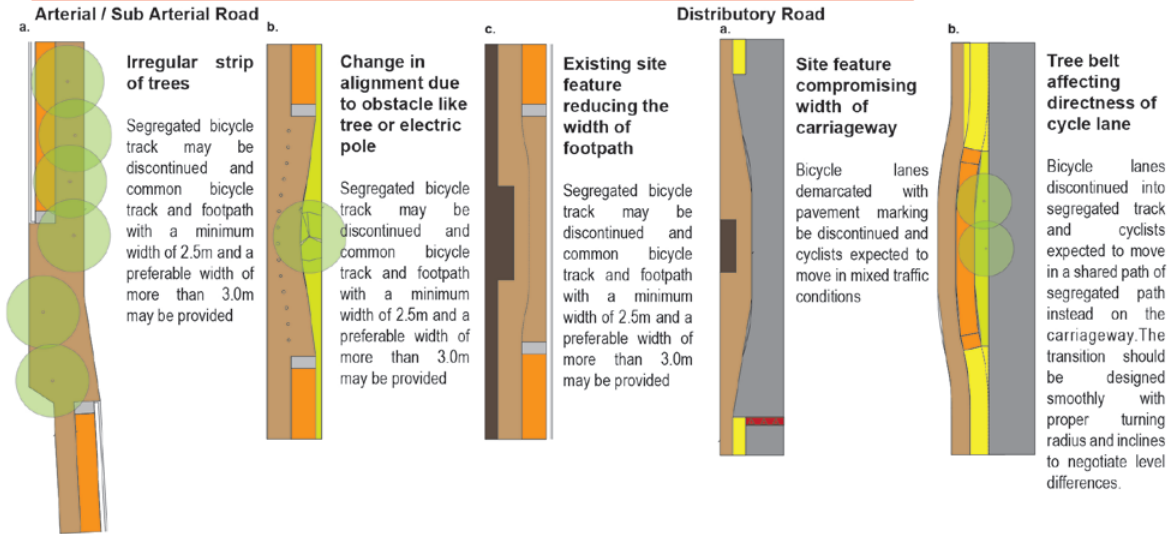

SPECIAL CONDITION : CYCLE RICKSHAW PARKING

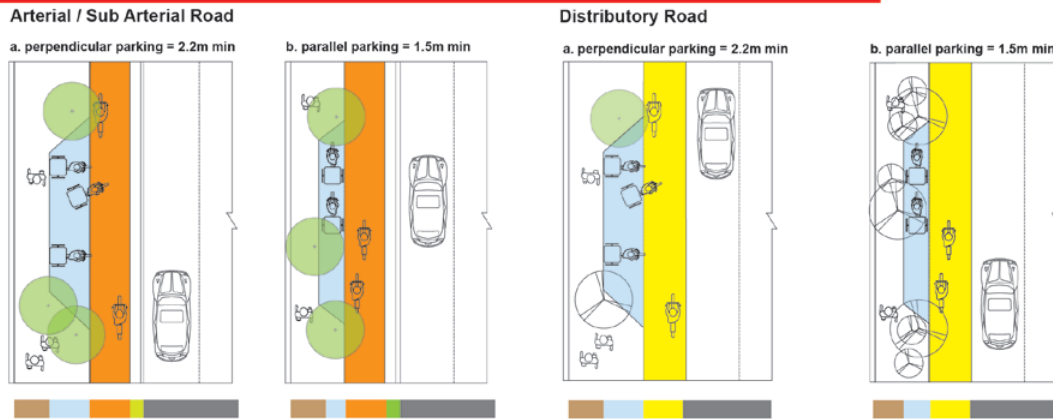

SPECIAL CONDITION : TSR PARKING

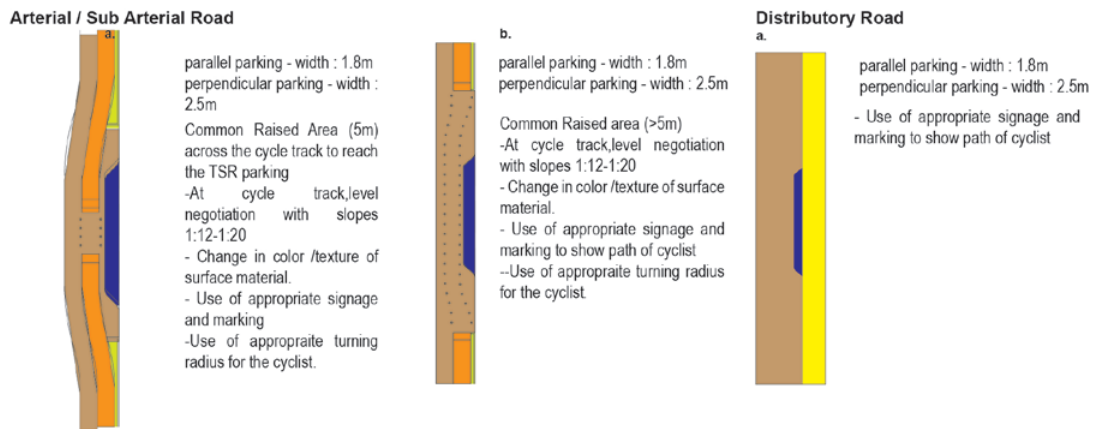

LEGEND

BUS SHELTER	CARRIAGEWAY minimum 2 lanes each direction	CYCLE LANE Width : 1400mm	CYCLE TRACK min width : 2200mm	FOOTPATH minimum width : 1800mm
SERVICE BELT	TREE BELT / SWALE	HAWKER SPACE	TSR PARKING BAY	CYCLE RICKSHAW PARKING BAY

Figure 26 : Special Conditions: Limitations upto 40m (Top) Cycle Rickshaw Parking (center) TSR Parking (Bottom)

3.5 Other Design Details

3.5.1 Riding Material Selection

Asphalt, Concrete, interlocking tiles, pavers, granite, stones, etc. have been used as a surface material for cycle infrastructure. The materials used for bicycle infrastructure construction should meet the requirements of being theoretically sound, validated experimentally and capable of reasonable testing and comparison. The materials should also have the desired level of workability, economy, strength, durability and volume stability; wear resistance and impermeability. Road authorities usually select between materials for closed surfacing and open surfacing on the basis of cost, maintenance and repair work for different agencies. But cyclists have a clear preference for closed surfacing, such as asphalt and evenness because it has the least resistance and is the most comfortable. The components of bicycle infrastructure mentioned will actually consist of the inner subsurface material and surfacing material. There are bound to be some irregularities in closed surfacing materials like cracks, fissures and projections. Table 18 indicates the acceptable surface irregularities on bikeways. Table 19 gives a comparable picture:

Riding Quality/ Evenness of Surface: Attractive riding comfort for cyclists can only be achieved with a well paved, smooth lane free of irregularities like cracks and fissures which can be easily achieved by the use of asphalt and concrete. Holes and bumps can cause bicyclists to swerve into the path of motor vehicles. Apart from an uncomfortable riding experience, it can lead to resistance in cycling experience.

Skid Resistance (CROW, June 2007) : Skid resistance of paving is generally determined by its texture. Texture includes macro-texture (which offers room for rainwater and dirt) and micro-texture (roughness of the individual stone particles in paving material). Skid resistance governs the safety of the cyclists and affords riding comfort.

Ease of Maintenance & Repair: By design, no cables and pipes for services should be placed under the cycle tracks else it would definitely affect the riding comfort of the bicyclists since they require constant maintenance and detour cyclists from their natural path. Road authorities must allow laying of asphalt/concrete over pipes and cables only if the cost estimation required for movement or reworking is available. The repair work should give the same results as the original and leave no patches or bumps on the road which gives riding discomfort. At areas where there is snow, snow and ice clearing has to be taken into consideration. Durability and management is an essential for selection of road materials. High maintenance materials such as granite and expensive stone finish are not preferred.

Drainage: Improper drainage results in an unsafe and uncomfortable riding experience. It also makes the facility unattractive.

Capital Cost: The cost of kerbing is an important part of the total cost. For e.g. Well laid tile paving including kerbing is more expensive than asphalt and concrete paving. As a prerequisite, the foundations should be wider than the paving to help control edge damage. It also leads to safety in the case of mishaps.

Cost of Maintenance & Repair: Materials which have high durability will not require high maintenance and regular repair.

Pavement Strength: Design and engineering judgment is required when selecting the material; keeping in mind the heavy traffic, asphalt or concrete is preferred.

Functional Appropriateness: Use of a material should satisfy the visual comfort or highlight the requirement of function. It would affect the attractiveness, safety and comfort as requirements of a cycle infrastructure.

The advantage and disadvantage of each material and its description is available in annexure 3.7.8.

3.5.2 Integrating Traffic Calming Measures

The variation in speeds between vehicles is the major cause of accidents. Establishing a speed zone is a design-enforced methodology where the three basic elements, infrastructure, road users and the vehicle, are adapted to each other. Here infrastructure design can be instrumental in ensuring safety by effecting the user and vehicle behaviour.

Table 18 : Irregularities on surface

Orientation of Irregularities	Cracks ¹	Projections ²
Parallel	13mm wide	10mm high
Perpendicular	13 mm wide	20mm high

1) Cracks/Fissures in the surface. Often found in hot mix asphalt surfaces or between slabs of Portland cement concrete. 2) Projections: abrupt rises in the surface of the travelled way. May be caused by sinking drainage grates, crude patching of the surface, and partial erosion of a layer of asphalt, pavement joints, pedestrian ramp transitions, or root growth under pavement.

Table 19: Comparison of material selection

	Asphalt	Concrete	Paver Blocks	Clinker Bricks / Quartzite	Granite
Riding Quality/ Evenness of Surface	1	2	3	3	1
Skid Resistance	2	2	2	1	4
Ease of Maintenance & Repair	2	1	3	3	3
Capital Cost	1	3	2	2	2
Cost of Maintenance & Repair	2	1	3	3	2
	1 (Desirable) >>>> 2 >>>> 3 (Undesirable)				



SPEED HUMPS



CHICANES



RUMBLE STRIPS

Figure 27 : Traffic Calming measures: Humps(L) (www.seton.net.au), Chicanes(C) (www.streetswiki.wikispaces.com), Rumble Strips(R) (Chandigarh)

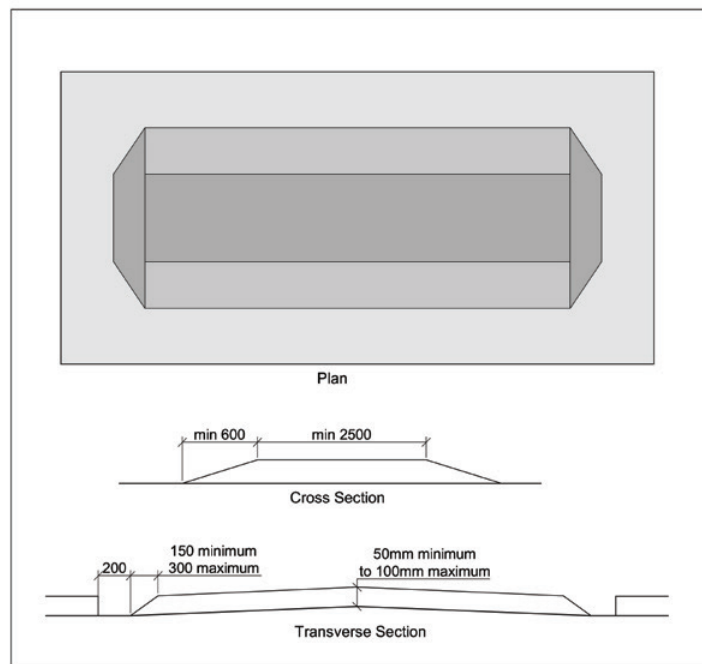

Figure 28 : Trapezoidal hump

Influencing the user behaviour by using visual warnings / pre warnings such as signage and markings or physical and psychological warnings like humps, speed tables and table tops helps to inform the user in a visual or palpable way about a change in the road situation. Similarly, influencing the vehicle behaviour by a specific change in geometric alignment reduces speed. They need to be logistically positioned and be visible from a distance for the user to react. Signs and markings should be effectively placed and are used as advance warning/pre-warning to road users.

Figure 27 shows various types of traffic calming. This includes narrowing, chicanes, speed humps, rumble strips and table tops. It is important to understand that traffic calming is taken up to bring down the vehicular speed similar to that of NMT. In an Indian scenario, chicanes and narrowing have not been as successful as in the west due to the high number of two wheelers. Also, to curb speeds of two wheelers the speed humps should be created on the entire length of the carriageway, else two wheelers detour path and pass at grade creating hazard for cyclists. **Speed Humps** are one of the most effective traffic calming devices and can be used on virtually any kind of road, with posted speed limits of up to 50 Km/hr. Speed Humps most successful for Indian streets are trapezoidal and table tops. It has been seen that sinusoidal humps are also successful in Europe. However they require much more supervision during construction. Trapezoidal humps have a flat top, which is generally 2.5m wide (Figure 28). If the flat top is 8m or more in width, it is known as the platform or table top (MOSTH, 2000) and is also used as a barrier friendly infrastructure (Figure 29). The maximum gap required between speed humps to maintain a speed zone of 30km/h, is 50 to 100m and for a speed zone of 50km/hr. it is 150 to 200m for 50km/hr, depending on the design of the speed hump and the speed of the vehicle on it. **Rumble strips** and bars generate a lot of noise and hence should not be used in residential streets. They may be appropriate for use at special mid block and junction approaches on arterial and other non residential distributor roads. In addition it may be advisable to use rumble strips as pre-warnings to speed humps (50-100m before) on arterial roads where approach speeds are higher and pre-warning is desirable. Detailed working drawing of table top crossing has been given in annexure 3.7.7.

3.5.3 Edge Treatments

The path of a cyclist is identified by the edges on both sides of the infrastructure. Depending upon the form and type of NMV infrastructure provided, the solution of the edges differs with the use of a kerb, green hedges, bollards, etc. Green areas provide shade, qualitative spaces and an ambient environment for not only cyclists but all road users. Trees and planters reduce the glare of concrete on roads during the dry and hot Indian summers. The usage of cycle track and pedestrian path depends on shade since in most parts of India, extended summers prevail. It should be kept in mind that the height and level of the edge condition should be treated as a vertical obstruction and adequate shy away should be provided to not compromise the requisites of NMT infrastructure. Figure 30 shows various edge treatments along cycle infrastructure.

For Arterial Roads, the provision of cycle infrastructure is segregated and has to respond to two different edge conditions. One side is towards the carriageway and the other towards the footpath. The edge condition towards carriageway is a kerb or a verge of bare minimum 0.75 m though 1.5 m is desired. The level of the cycle track and the verge could be of the same height or with a maximum level difference of 50mm. This could function as a utility zone for water to slope into the verge and locating sign poles and other vertical utilities provided within adequate shy away. Also, not having any level difference between the two areas has its advantages. The space could be seen as an extension of the cycle track and during peak hours or high volumes, such areas can be used by overtaking cyclists. It is not advisable to have a kerbstone edge without a verge because it is easier for two wheelers to misuse the NMV facility for overtaking and using it as another lane for seamless movement. This should be managed by enforcement. The edge condition towards the pedestrian path can be physically segregated by introducing a level difference of 75mm (maximum) between cycle track and footpath or by introducing a green belt / utility area where the ROW permits. This width of the green belt could determine the kind of plantation i.e. from hedges to a regular/irregular tree line based on the landscaping plan. All vertical installations like light poles and sign poles can be located in this area (alongwith support facilities like hawker spaces, benches, etc), thus making the cross section safer for all modes and making the cyclists more visible to the fast moving traffic. In both the cases mentioned above, the width of the verge should not be so wide that it compromises the requisites of a cyclist like directness, coherence and safety. The designer should



Figure 29 : Traffic Calming measure - Table Top Crossing at Bus Rapid Transit System, Delhi (Source: TRIPP, Delhi)



Figure 30 : Edge Treatment : Deterrent Strip (top) www.cyclotouringbc.com/(L) www.pexco.com(R), Bollards (Middle-L)&(Middle-C), Curb laying at Rajkot BRT (Middle -R)Green & Utility Belt, Delhi BRT (Bottom)

Table 20 : Cumulative percentage of mobility impaired people observed to be unable to move more than the stated distance in city centres without rest (County, 2005)

	18m	68m	137m	180m	360m
Wheelchair Users	0	5	5	60	85
Visually Impaired	0	0	5	50	75
Ambulant Disabled with walking aid	10	25	40	80	95
Ambulant Disabled without walking aid	5	15	25	70	80

carefully look into this aspect in the interest of the cyclists. It is quite possible that due to available width and ROW, landscape plans are designed with tree lined avenues etc. This should be done with careful discretion not compromising the choice route of the cyclist.

For Distributor Roads, Deterrent strips are cycle segregators. If the cycle lane is placed just next to the parking bay, the cyclists must be able to keep a safe distance from parked cars without deviating from the lane. For Indian roads (with speed limit of 30 km/hr), there are two methods in which the deterrent strip can be implemented. It could either be a 500mm painted strip or a 500mm slight depression on the surface to provide a tactile warning to the parked vehicle. In case of distributor roads, since the cycle lane is painted, if there could be a segregator between the footpath and the painted lane, the collection chamber could be put there which would prevent installation of grating in the lane and would prevent injuries/ accidents to cyclists. However, streets where there is a high degree of friction from on street parking and usability of lane is endangered, it is highly recommended to change the form of the lane into a track as discussed in section 3.4.3.

3.5.4 Road Furniture and Support Facilities

Street furniture and support facilities are important elements that enhance the comfort, visual quality, convenience and security for cyclists and pedestrians. Street furniture includes benches, bollards, etc. They provide comfort and rest areas for both pedestrians and cyclists. They can help in identifying an area of different function. The most important property of any street furniture should be that it be vandal-proof, easy to clean and preferably maintenance free.

Support Facilities: Hawkers and street vendors are a small yet significant component of road users. Their presence on the street not only helps increase safety, but their services provide convenience to cyclists. Their presence is already admisible on the street roads; however they are not integrated in the road design. Their integration affects the comfort, safety and security of cyclists. Incase no provision is facilitated and no integration by design is undertaken, there is bound to be an encroachment on to the infrastructure provided for other users. The activity survey will help identify the type of hawker, area occupied by the hawker, location with respect to places of importance / nodes / junctions, time period and frequency. A study on the activity survey and an interview with the hawkers should give outcomes, which will become the determinants in design. Table 21 shows generic determinants which should ensure 90% usage and would minimize conflicts between users..

Street Furniture: The use of street furniture definitely assists in improvement of the urban quality of road infrastructure. In addition to its aesthetic quality, street furniture plays a role in segregating spaces and adding facility for different users. The following should be taken into consideration while adding street furniture:

1. Vandal-Proof. All street furniture should be vandal-proof.
2. Easy to install.
3. Requires little or no maintenance.
4. Attractive design.
5. Economical design.
6. Ease in production.

Use of dustbins and location of amenities such as public toilets, kiosks, information booths are other types of street furniture that make the infrastructure more attractive.

Table 21: Generic Determinants for a designed space for street vendors.

Location	It should be such that the spill-over of activities or clientele does not encroach on to the cycle track. It is very rarely seen that mainstream cyclists use these facilities. The ideal location is integrating the space after allocating space for the carriageway, lanes/tracks and pedestrian paths. The hawkers can then be integrated along the pedestrian path in case of arterials and along the carriageway between parking bays in a distributor street.
Type	The types of hawkers are the same that have been identified from the land use survey. Also, the design could answer the need of areas that would enhance the urban quality of the roads with landscapes and other street furniture. This way, the area of collection / activity would be concentrated and limiting.
Material	The use of material can be same as that of the pedestrian path or a mix of materials can be used to evolve a pattern in the paving to make it more attractive.
Edge treatment	The edges could be designed using street furniture like benches and bollards.
Change in elevations	It would not be wise to segregate levels from the pedestrian path since it will not ensure a fluid movement of their clientele. A visual segregation works the best in such cases since it is also easier to demarcate territory, incase regulations are to be enforced.
Access	Many street vendors use bicycles and wheeled-carts. A mountable kerb and provision of ramps for various levels must be provided.



Figure 31 : Integrated use of bollards and support facilities (Source : Bus Rapid Transit, Delhi)

WHITE BROKEN LINE

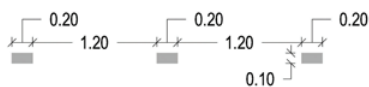

To mark the center of the cycle track to indicate two lanes (dimension in 'm')

Color : white

BROKEN WIDE LINE

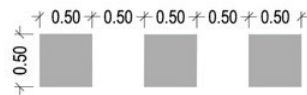

It is used to indicate the cyclists crossing when in conflict with turning MV's. (dimension in 'm')

Color : White

YIELD MARKING



It is used to indicate that the traffic towards which the vertex of triangle points should slow down or give preference to the traffic coming from opposite side. (dim in 'm') Color : White



Color : White

WHITE SOLID LINE

To mark the right edge of the left turning cycle track. Also, it is used to segregate a bicycle lane from the carriageway. It is continuous throughout except when it encounters an intersection or a side road meeting the main corridor or TSR parking spaces.

Color : White

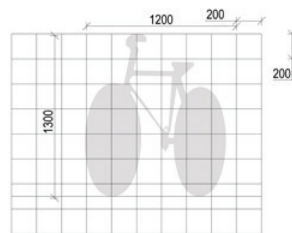

For Cycle Tracks/ Lanes

Color : White

CHANNELIZING LINE

Used : before the intersection while exiting the cycle track and after the intersection while entering the cycle track. (dimension in 'mm')

Color : White

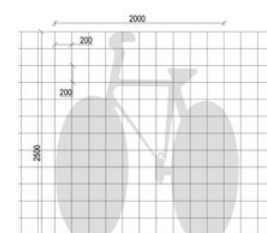

For Cycle Boxes

CYCLE BOX

It is marked parallel to the pedestrian crossing on the main intersection. It gives priority to the cyclists for waiting ahead of the motorists when the signal for turning right is red. (dim in 'mm')

Color : White

Figure 32 : Cycle Specific Road Marking

3.5.5 Signage

Signage plays an important and complementary role (along with road marking) to inform the cyclists as well as other road users about the nature of the cycle infrastructure in the zone. They play a critical role in enforcing speed limits. The signage system comprises of regulatory, informatory and warning signs, as per Indian Road Congress (IRC 67). The size of the signage depends upon the design speed. Therefore the maximum size is used for arterial roads and the minimum is used for access and distributor roads. However, in specific cases where the role of the signage is more important, the bigger size is used. In the recent revision of IRC: 67, Code of practice for road signs, (Indian Roads Congress (IRC), 2012) many signs have been modified first as new ones have been added to address the cyclists and other road users. Design of Urban Roads, Code of Practice (Part-4), (MoUD, 2012) , highlights a comprehensive data of signage for road users.

Figure 33 covers signs specific to bicyclists. Figure 34 shows some with their area of application.

3.5.6 Markings

Like signages, markings too inform the cyclists as well as other road users about the nature of the road infrastructure. They act as guides and provide advance warnings signs to caution the road user. A comprehensive description of various kinds of markings used has been explained in IRC:35, Code of practice for road markings, (IRC35, 1997) and Design of Urban Roads, Code of Practice (Part-3), (MoUD, 2012). Figure 32 shows some cycle specific markings and Figure 35 shows their area of application.

3.5.7 Services and Utilities

Drainage - Drainage should be addressed while designing cycle lanes and tracks to prevent ponding and erosions during rains. Improper design of gully gratings, water collection on the edge of bicycle lanes/tracks are to be avoided. In arterial roads, by design there should be a segregated bicycling facility or a cycle track. As mentioned earlier, no services that require regular maintenance should be laid below the cycle track. The green verges discussed earlier should have the provision of gratings that take surface water from the carriageway as well as the cycle track (slope 2%). Water travels through a pipe to the storm water drain (Figure 36). In case a segregated facility is provided with the main storm line, it should be flushed to the floor of the cycle track and the drain should be aligned along one edge so that in times of an open manhole or when annual maintenance work is being carried out, one side is available for movement. For distributor and access streets placing a collection grating along the edge of the footpath can be placed. A bell mouth arrangement to collect water is not recommended. The grating should be flush with the floor of the carriageway and the cover should not hamper the movement of cyclists. The cover of the grating should be perpendicular to the direction of the travel of bicyclists so that the tyre does strike it.

Lighting - Street lighting makes the available space legible for each road user. The illumination of a street is governed by the posted design speed. For cyclists, lighting also adds to the comfort of the ride. In fact, lighting is the basic street furniture required in the functioning of the entire cycle infrastructure network.

Location of Poles is decided depending upon the category of the road. It could be the central verge or at the sides where a segregated cycle facility is available. Two luminaries can be mounted on a pole located between the carriageway and the cycle track at different height to light the required area with the required lux levels. This would also reduce the number of poles required and the vertical clutter on any given road. Lighting specifications (based on design for Delhi BRT Corridor – ROW 45M avg) for a cycle facility are as follows:

- At no point along the lanes, average horizontal illuminance should be less than minimum 40 lux.
- Uniformity Ratio: (E Min / E Avg): 40%
- Mounting height: 6m (Luminaires should be located to avoid formation of shadows from tree foliage).
- Luminaire to luminaire Spacing: 20m (Better spacing than this will be appreciated)
- Type of Lamp: Metal Halide

REGULATORY

Prohibited Parking in Non- Motorized Lanes: Used to prohibit parking on the segregated cycle lane.

Cycle Prohibited
Note - to prohibit cyclists from using elevated roads like flyovers be at grade.

Compulsory cycle track/cycles only

Compulsory Route For Cyclists & Pedestrians

Segregated Cycle & Pedestrian Route

Compulsory Route for Cycles & Buses

Source : (MoUD, 2012)

Warning

Cycle Crossing

Cycle Route Ahead

Prohibited Parking in Non-Motorized Lanes: Used to prohibit parking on the segregated cycle lane.

Common Lane for Cyclists and MV: To warn motorists of the cycle users, wherever the cycle track is painted and not segregated

Source : (Indian Roads Congress (IRC), 2012)

Source : (MoUD, 2012) Source : (MoUD, 2012)

INFORMATORY

NMV Parking: Located at cycle parking areas.

NMV Track: Indicating segregated cycle track

Common Cycle Track and Footpath: Used at locations where pedestrians and cyclists share the road

Differently-Abled Environment: Indicated at locations which have wheelchair access and are accessible to the differently-abled.

Ramps: Used to indicate locations of ramps at the subways and/or foot-over bridges, which are accessible to the differently-abled.

Source : (Indian Roads Congress (IRC), 2012)

Source : (MoUD, 2012)

Public Toilets: Used at public Toilets accessible to different-abled, arrows can be used to indicate directions

Public Telephones: Used to indicate locations of public telephones, which are accessible by the differently-abled

Parking for Differently-Abled: To indicate the demarcated parking space for the differently-abled persons

Source : (MoUD, 2012)

Source : (MoUD, 2012)

Figure 33 : Roads Signs specific to cyclists.

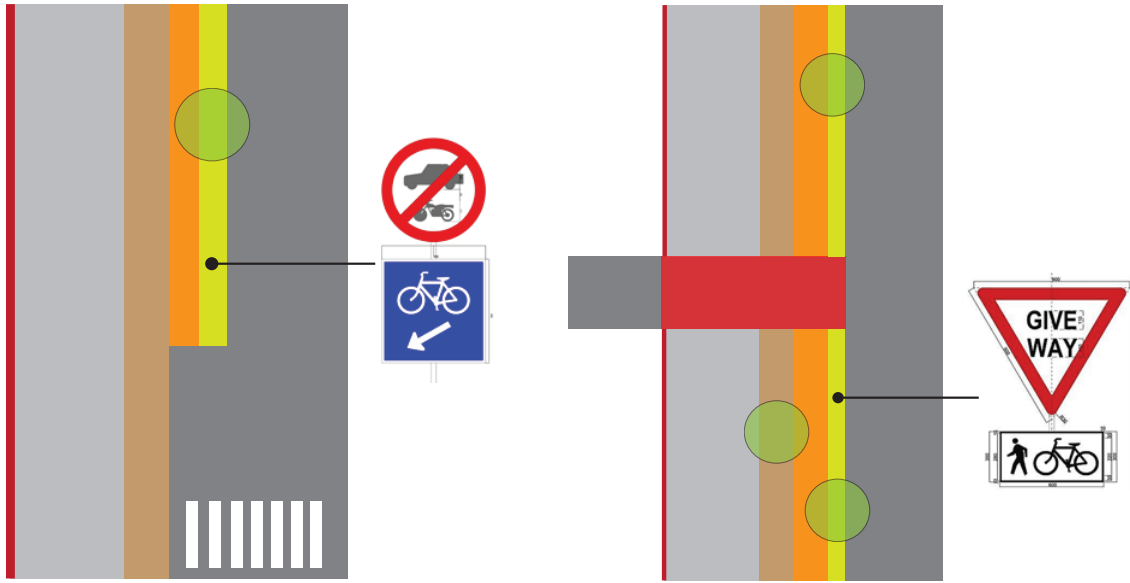

Entry to the cycle track

Raised Crossing - Conflict with entering and exiting vehicles to side road

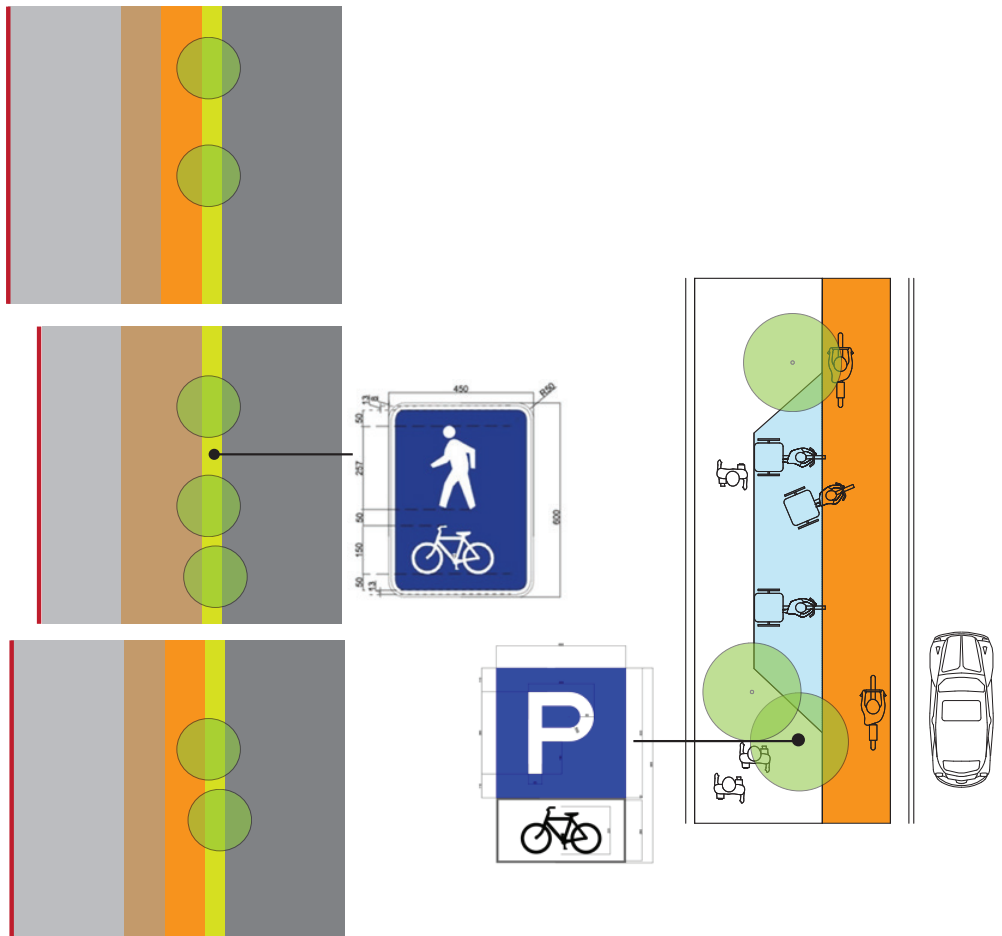

Shared Cycle Track & Footpath

NMV Parking / NMV Rickshaw Parking

Figure 34: Area of Application - Signages

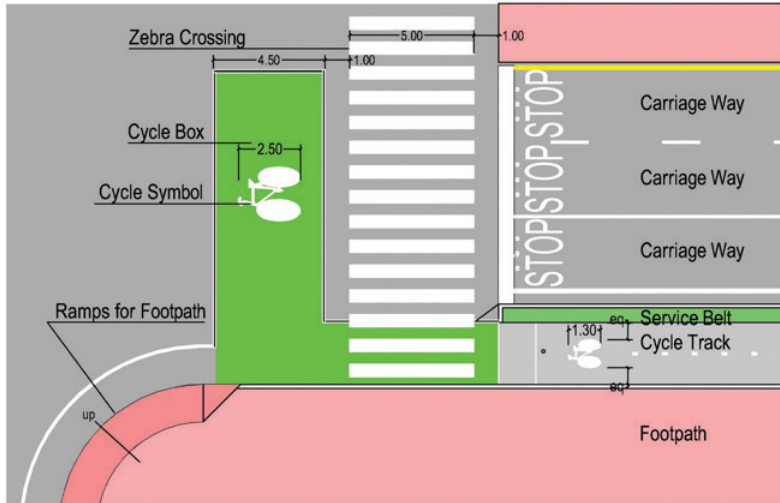

Shared Cycle track and Footpath

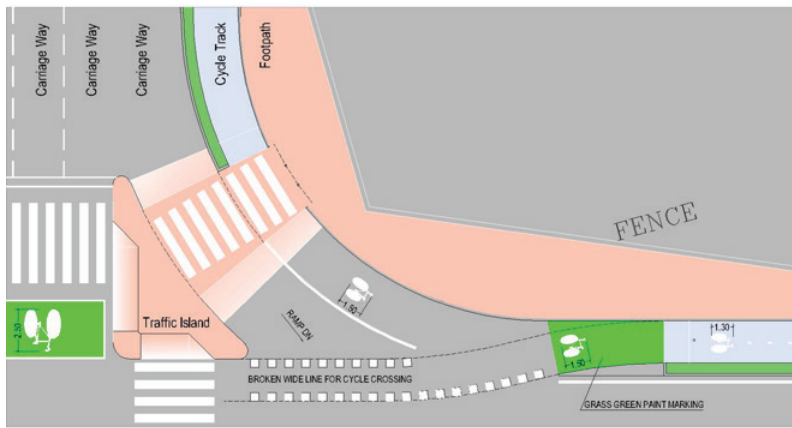

Shared Cycle track and Footpath

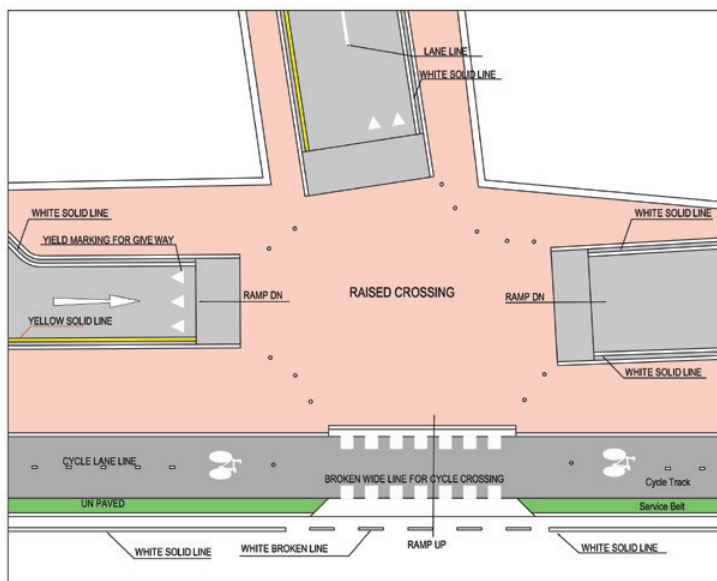

Shared Cycle track and Footpath

Figure 35 : Area of Application – Marking

Color of Light: Street lighting should produce enough intensity required for face recognition and objects from a particular sight distance. Especially for the purpose of social safety, women and children are a special group for whom the color of light is of added importance. White light is a preferred choice. The advantages of white light are as follows: In a segregated facility, it easily distinguishes between the fast and slow moving zones. It creates contrasts for pedestrians with tactile paving provided for the differently-able and the visually impaired.

Other Under and Over Ground Utilities: Apart from the lighting and drainage that is required for a comfortable riding experience, there are other utilities that affect the comfort of cyclists. Table 23 shows the various other utilities, overhead and underground, that can affect the cyclists' infrastructure as well as movement. There are various utilities running longitudinal and across the ROW of any category road. These include storm drains, underground and overhead electrical lines, gas pipelines, optical fibre cables and others. Usually it is seen that an annual maintenance is required which involves roadwork and therefore disruption of movement of traffic for a temporary period. In such a case, the location and depth of laying these utilities is of utmost importance. Also, for a segregated cycling facility, since the paving is rigid, it is not desirable to locate the services/utilities, which require frequent maintenance. The important point is to rationalize all available existing and proposed services in order of their maintenance works and see that they do not come in the way of the efficiency and functioning of cycling services (as mentioned in the guiding principles).

3.6 Parking Facilities

It is essential to retain the captive cyclists in the future. To do that, cyclists must be provided similar facilities/provisions to car users. Hence it is of the utmost importance to provide well designed and integrated parking facilities for cyclists. Good parking facilities also help attract new users thereby promoting cycling.

Provision of parking is not a new concept. Railway stations in most of the cities have a cycle parking facility for commuters who travel to place of work using trains. All government institutions have a designated parking space within the premise for cyclists. However, the main thing lacking is that an entire network for different types of cycle parking facility is missing on our roads. Some of them have been shown in Figure 37. Measures by the government to provide public parking near informal households or slums, which also are origin points, would definitely be fruitful to a cycling route and the network across the city. In residential areas, to ensure use by current cyclists and even to attract new bicyclists, functions like places of gathering and market areas must have safe parking facilities. Parking areas can be immediately identified and designated using a marking material like a thermoplastic material. Areas like a community centre, post offices, etc must have such facilities for people living in the vicinity and access the services. Rickshaw-parking stands will make the area much more inclusive, help many to cover the last mile connectivity, travel short distances and encourage using non-motorized modes. Similarly across the city, integration of parking with transit stations, bus stops, market places, places of gathering, public spaces etc will make the provided cycle infrastructure much more connected and attractive to use. Designated and visible parking for passenger cycle rickshaws and goods rickshaw (in commercial areas) etc (every 200 – 300m and based on activity survey) has to be provided at important nodes and places of importance.



Figure 36 : Drainage for arterial streets (Source : SGArchitects, Delhi)

Table 22 : Depth of laying various Services (MoUD, 2012)

S.No	Type of utility	Depth (in meters)
1	Trunk Sewer Line	2 to 6m
2	Water Supply line	1 – 1.5
i	Service Line	0.6 - 1
ii	Trunk Line	1 – 1.5
3	Electric Cable	1 – 1.5
i	LT Cable	0.6 - 1
ii	HT Cable	1.5 - 2
4	Telecommunication cable	2 - 3
i	Directly laid	0.6 - 1
ii	Laid in ducts	2 - 3
5	Gas Mains and lines carrying combustible materials	2 - 3

Table 23 : Effect of Services on Cycle Infrastructure and Movement

Services/Utilities	Effect on cycle movement	Infrastructure Modifications (incidental)
ELECTRICAL (overhead services)	Minor effect	In case a work is overdue it is advisable that the work is taken up before introducing bicycling infrastructure.
ELECTRICAL (underground services)	The maintenance work will definitely affect in the movement in cycle track	In case a work is overdue it is advisable that the work is taken up before introducing bicycling infrastructure.
OPTICAL FIBRE CABLES (OFC)	Minor affect	In case a work is overdue it is advisable that the work is taken up before introducing bicycling infrastructure.
GAS PIPE LINES	No effect. The cycle track can be constructed over Gas pipeline. Not much effect on movement.	In case a work is overdue it is advisable that the work is taken up before introducing bicycling infrastructure.
TELECOMMUNICATION	No effect. They are usually located at the rear footpath.	No effect

The advantage of cycle rickshaw parking over cycle parking is that it would not require manning; theft is very rare and parking covers a very low share of investment in terms of infrastructure. Since it acts as a feeder mode, it would cater to short trip lengths of 1.5-2km, the introduction of frequency of cycle rickshaw parking would fairly increase in densely populated residential (passenger rickshaws) and commercial areas (passenger and goods rickshaws). The percentage of the space allocated for goods rickshaw parking in a commercial area would be higher rather than that of residential areas.

The various elements of cycle parking have been addressed in Table 24.

Table 24 : Elements of cycle parking

Elements of Cycle Parking
<p>Location: These can be easily identified with the use of activity surveys done for a particular zone, district or city. These locations could be in the proximity of: transit stations, places of importance, junctions/interchange, nodes, informal settlements/ slums, etc.</p>
<p>Space/Area: Space allocation is based on the activity survey, the existing capacity of the corridor and discretion of the designer. The space allocation should be 20%-30% more for optimum use in the future. Capacity requirement needs to be assessed in detail.</p>
<p>Theft Control: It should be kept in mind that investments to prevent thefts would only lead to an increase in the number of cyclists and make it an attractive and safe mode of travel.</p>
<p>Manned or provided: Parking facilities can be manned or provided. While the manned provision needs an extra investment to make it theft free (hire security personnel), the latter is providing good fastening locking facilities to a designated parking area.</p>
<p>Shade: Much needed for Indian conditions, shade is required for cyclists. This could be done by the providing parking under existing trees or use of temporary structures.</p>

Forms of bicycle parking: The most popular form currently used in a number of cities is the wheel clamps or the inclined wheel braces, used in office properties, schools, metro stations/railway stations where the risk of theft is quite low. The other types of bicycle parking facilities used are:

1. Hanging system bars
2. Hanging system on walls
3. Tiered racks – such is used at railway stations where the cyclists travels to the suburbs for work.
4. Binder racks
5. Bolt locking system – frame type/ wheel lock
6. Fastening poles
7. Support rack
8. Brace rack

Others, where the volume of bicycle parking is larger are: Canopies and designated parking lots.



Lack of designated and safe cycle parking; Cycle rickshaw stand (L) Cycles parked in pedestrian path at Nehru Place, New Delhi (R)



Designated Cycle Parking at IIT Delhi Campus



Designated Cycle Parking at BRT corridor (L); India Habitat Center, New Delhi (R) (Source : Divya Menon)

Figure 37 : Bicycle parking

3.7 Annexure

3.7.1 Comparison between bicycle and cycle rickshaw

Similarities	Differences
They have similar speeds and control	Bicycles have much higher flexibility than cycle rickshaws.
Both bicycles and cycle rickshaws do not have any shock absorbing systems	Bicycles are much smaller in size than rickshaws, which can be 0.95 to 1.25m in width (though widths are comparable when cyclists carry goods such as gas cylinders).
Both bicycles and cycle rickshaws are used for ferrying goods	Parking requirements for bicycles and cycle rickshaws vary considerably

3.7.2 Total Station Survey – Checklist

The accuracy of the survey and the control/benchmark points, with site references ensure that the digital survey equipment can be effectively used for accurate layout of computerized drawings on site. The total station survey will include the tasks to be carried out:

1. The survey should clearly show the master plan and available Right of Way (ROW), as separate layers. The drawing should be provided in 2D and 3D (Digital Terrain Model (DTM) drawing). Width of carriageway, footpaths, central verge and drains should be clearly indicated. Where there is a sudden change in width of road, physical measurements should be marked on the drawings.
2. The survey should also depict Road / lane name and location of all the approach roads with marked level crossings (if any) with their numbers, class, manned or unmanned, Road-Over-Bridges (ROBs) Road-Under-Bridges (RUBs) and Foot-Over Bridges (FOBs), Railway bridges with their structural details, angle of crossing and road & rail levels with storm water drains, open drains and nallahs with bed levels, HFL and manhole details should be made clear. Details of existing flyovers including details of at-grade service roads at such locations should also be marked.
3. Dimensions and details of built-up areas including setbacks from building line/boundary wall and type of edge (fence/ wall/ etc), with plot numbers should be indicated. Other observations which need to be marked are ownership such as private or government and usage i.e. residential or commercial etc. within survey limits, type of building such as temporary, permanent including their number of storey's and basement details. Details of religious structures such as temple, Gurudwara, Mosque, Church, Monuments, tomb, etc. should be clearly marked. Other details that need to be recorded are: details of land along the route and their uses such as residential, commercial, religious, parks, green areas, vacant lands etc; name of all the adjacent colonies including their boundary conditions, jhuggi Clusters with boundary conditions along the route, and squatters. Details of access steps and ramps, corridors, columns etc. Demarcation of plinth in plans needs to be marked. Details of overhangs, first floor extensions etc. along with encroachments on the right of way (ROW), location of gates, entry and exits to be clearly indicated. The building blocks should be named similar to their existing names assigned by the municipal body.
4. Utility services such as electric lines, telephone lines, and transmission lines need to be marked. Vertical Clearances to power line or telephone / telegraph lines at road crossings and at locations where Flyovers are proposed should be observed. This also includes marking all the traffic signals, light posts, bus stops, Junction boxes (telephone and power), wire and water hydrants (fire fighting and others), transformers, telephone posts. Any other structure or details which may be relevant and observed on site needs to be indicated.
5. All trees with their location and type needs to be marked. This includes girth categorized in numbers T1, T2, T3, T4, (with the diameter of 300mm to 600mm, 600mm to 1200mm, 1200mm to 1800mm 1800m m and above. All trees with girth more than 30 cm need to be measured at 1 m height from ground level. Other features like water ponds, fountains etc. need to be indicated on plan.
6. Access area beyond ROW to metro stations, if any, needs to be marked. This includes ramps, pathways,

opens paces, entry /exit gates. Comprehensive detailed survey of the bus terminals such as footpaths, area for circulation, sheds and parking spaces, other building and structures within the premise, utilities etc should be indicated in plan.

Reduced levels of all traverse stations shall be taken by Double territory method. Levelling shall start from a Great Trigonometric Survey (GTS) benchmark and closed at the same point after carrying out levelling of traverse stations. Control points established along the alignment shall be referred to as temporary benchmarks. TBMs (Temporary BenchMark) should be located at an adequate distance (every 1km) and at critical locations. Intermediate GTS benchmarks, if any are also to be connected. All control points/ TBMs shall be installed at ground using bars/bench markers, if they have not been established on permanent structures.

3.7.3 Activity Survey – Checklist

The following activities should be recorded as accurate Auto-cad symbols:

1. Hawkers by type (such as cart, kiosk, sitting on ground, etc.), area occupied (shown in CAD)
2. Parked vehicles with vehicle type, location, shape, size, orientation, etc.

Time, location and duration of the survey: Activities should be recorded as per the following time schedule:

1. All activities as mentioned above, should be recorded on working days on marked road network. These should be recorded twice at two time periods, i.e. 12:00 pm to 5:00 pm and 09:00pm to 12:00am. (any other time required is site specific).The activities recorded should include a broad time stamp.
2. In addition, the activity survey should be conducted on stretches of the road hosting specific activities at defined times.

3.7.4 Traffic Volume and Pedestrian Survey

a) Vehicular Volume Counts:

Number of Sites and Time of Survey should be selected for vehicular traffic volume counts. The survey conducted can be for 8hours/ 16 hours / as per need for a single working day. Timing of the survey should be identified (on a typical working day i.e. excluding Saturday and Sunday). Locations for the volume counts are selected in such a way that they capture the total traffic entering into and leaving the area of influence. At each of the locations identified, pedestrian volumes for every 15 minutes should be recorded.

Type of Data to be collected - Mode and direction wise volume count at all sites/intersections should be collected and recorded in xls format. The duration of data recording unit should be 10 minutes. Vehicle classifications system should be as per IRC SP 41:1994.

Name of the Project																		
Name of Intersection/Junction: _____								Day : _____ Date :										
Location_ID: _____								Direction/ Movement From : _____										
Time Period	Motorised Traffic													Non Motorised Traffic				
	Passenger Vehicles							Goods Vehicles										
	Two Wheeler	Autorickshaw (3w)	Grameen Seva	Car/Jeep/Van/Taxi (Other than Taxi)	Bus				Goods Autorickshaw (3w)	LCV	2-Axle Truck	3-Axle Truck	MAV	Tractor / Trolley	Cycle	Cycle Rickshaw	Animal Drawn	Others (pl. specify)
					Mini Bus	DTC BUS	Chartered Bus	Pvt Bus										
:00																		
:10																		
:10																		
:20																		
:20																		
:30																		
Total																		

- The classification should include both classifications of motorized and non-motorized vehicles. Classification of buses should be further subdivided into public transport, chartered, mini and school buses.
- Data should be presented and submitted in tabular and graphical form. Data should be collected through Video recording at site and then extracted and inserted in x.l.s format at an offsite location.

Pedestrian Volume Counts:

A. Numbers of Sites and Time of Survey: A total of ten locations/intersections in the study area have been selected for pedestrian counts (including the 6 locations selected for volume count).

B. The survey time and the number of hours should be similar to that of the traffic volume survey.

Type of Data to be collected: Direction-wise volume count at all sites/intersections should be collected and recorded in spread sheet format. The duration of data recording unit should be 10 minutes. Data should be collected through Video recording at site and then extracted and inserted in spread sheet format at an off-site location.

Name of Project		
Direction:	Date:	Road Name:
Location:	Junction Name:	
Time		No. of People
:00 - :15		
:15 - :30		

:30 - :45		
:45 - :00		
Grand Total		

3.7.5 Parking Survey

Parking survey should cover all vehicle types and classifications as per IRC SP41:1994, and should include chartered buses, private cars, two wheelers, service vehicles (such as tempos and trucks counted separately), goods cycle rickshaws, cycles, etc. Data should be collected at continuous 16 hour counts at the entrance and exit of parking areas (formally and informally defined parking areas including notified and illegal parking areas). The surveyor shall identify adequate methodology to do so which may include tracking parking ticket purchase, determining ends of roads as entrance/exit points etc. At the beginning of the survey, number of vehicles parked inside an identified parking area should be counted. Subsequently, parking counts should be made (for entering and exiting cars) in a unit of 5 minutes for a continuous period of 16 hours. All data should be recorded in spreadsheet format. Parking data should be collected separately for each type of parking i.e. formal and informal parking, underground, surface and over ground parking (multi-level) and also exclusive parking spaces of office complexes on a single typical working day. The type and location of parking should be clearly identified in the spreadsheet submitted.

Name of Project					
Location:			Day :		
Date :					
Vehicle Type	Vehicle Registration No.	In Time	Out Time	Occupancy	Comments

3.7.6 Provision of Free Segregated Left turns

As mentioned in section 3.4.2, there are two solutions to accommodate left turning traffic:

Ignore Segregated Left Turning Lanes

Advantages	Disadvantages
Left turning phase is not signal free allowing cyclists and pedestrians to make a safe crossing and turning at junction during designated phases	Such designs are generally accompanied by provision of an extra left turning lane or left turning pocket on the near side of the junction. This increases the crossing distance for pedestrians requiring longer pedestrian phase time.

Controlled left turns ensure that conflicts between straight and (left) turning vehicles can be avoided during specific phases ensuring higher efficiency and throughput during the straight phase.	Where very high left turning traffic is expected (higher than 30%) (Gadepalli, 2008), provision of a non-segregated and signalized left turn may contribute to some delays for vehicular traffic.
Non-segregated left turning lanes reduce crossing delays for cyclists and pedestrians, as segregated left turns require staged and thus more crossings (separately across left turning lane and other traffic lanes) leading to accumulation of wait time at each crossing red light.	At junction where very high left turning traffic is expected, it may not be possible to separate left turning phase from straight phase on a traffic arm. Here cyclists arriving in the middle of the green phase may not be able to move with the motorized traffic for fear of conflicts with left turning vehicles
At junctions, where left turning traffic is expected to be significantly minor, provision of a left turning pocket with a left turning phase (independent of straight traffic) can be introduced. This allows cyclists arriving in the middle of a vehicular green phase to safely move straight across the junction with motorized traffic.	

Signalized and Traffic Calmed Segregated Left Turning Lanes

Advantages	Disadvantages
Traffic calming and signalization of segregated left turning lane makes it a controlled (and not signal free) left turn which allows safe gaps for pedestrians and cyclists to cross	Segregated left turning lanes introduce at least two more stages for crossing cyclists and pedestrians, making the crossing more complex and adding to their delays, and adversely effecting their directness (in time and distance)
Staged crossing ensures that smaller road widths or distances require to be crossed at a given time, making it safer for cyclists and pedestrians and also allowing a smaller and more efficient crossing phase in the signal.	Segregated left turn lanes with non-coordinated signals can result in conflicts between straight moving and left turning motorized traffic (on far side of the junction), resulting in reduced efficiency of signal plan.
Segregated left turn lanes with signal co-ordination for cyclists, can reduce delays for straight moving cyclists as they can be allowed to move unobstructed with straight motorized traffic even if they arrive in the middle of the green phase.	Segregated left turn lanes with coordinated signals (between left turning and intersection signal, i.e. straight and left move together in one phase), does not significantly benefit motorized vehicles and may be counterproductive at junctions where left turning traffic volume is high. Such co-ordination of signals also denies the cyclists, who approach the junction during the green phase, to move straight along with vehicular traffic.

3.7.7 Traffic Calming – Raised Crossing/Table Top

Case 1 – Segregated cycle track is punctured with frequent openings due to entry/openings on the edge

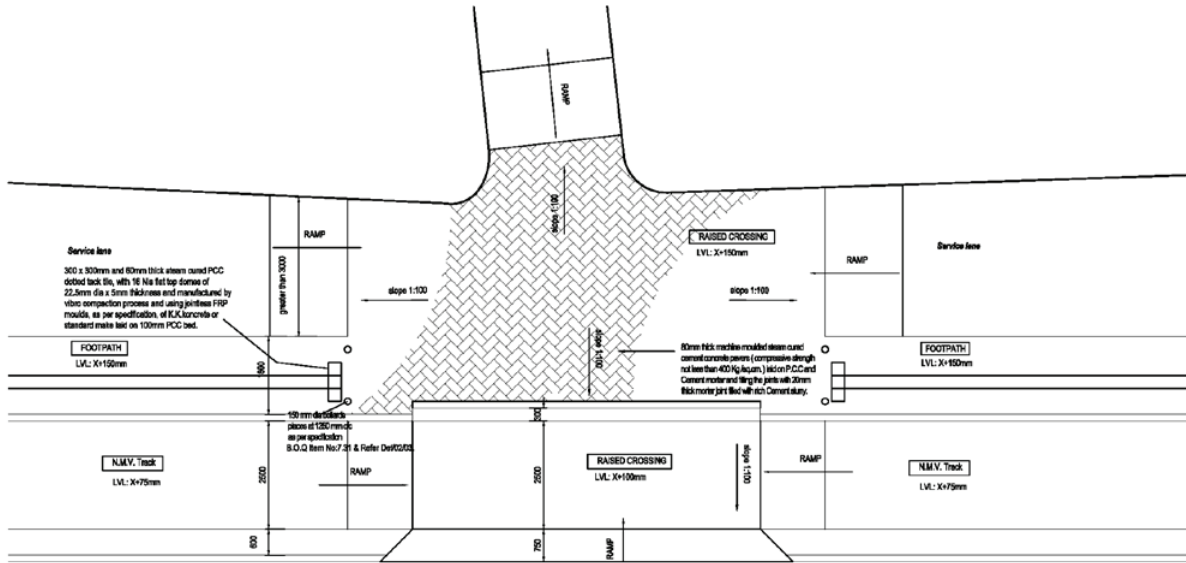

Case 2 – Segregated cycle track is punctured with less openings to the side lane

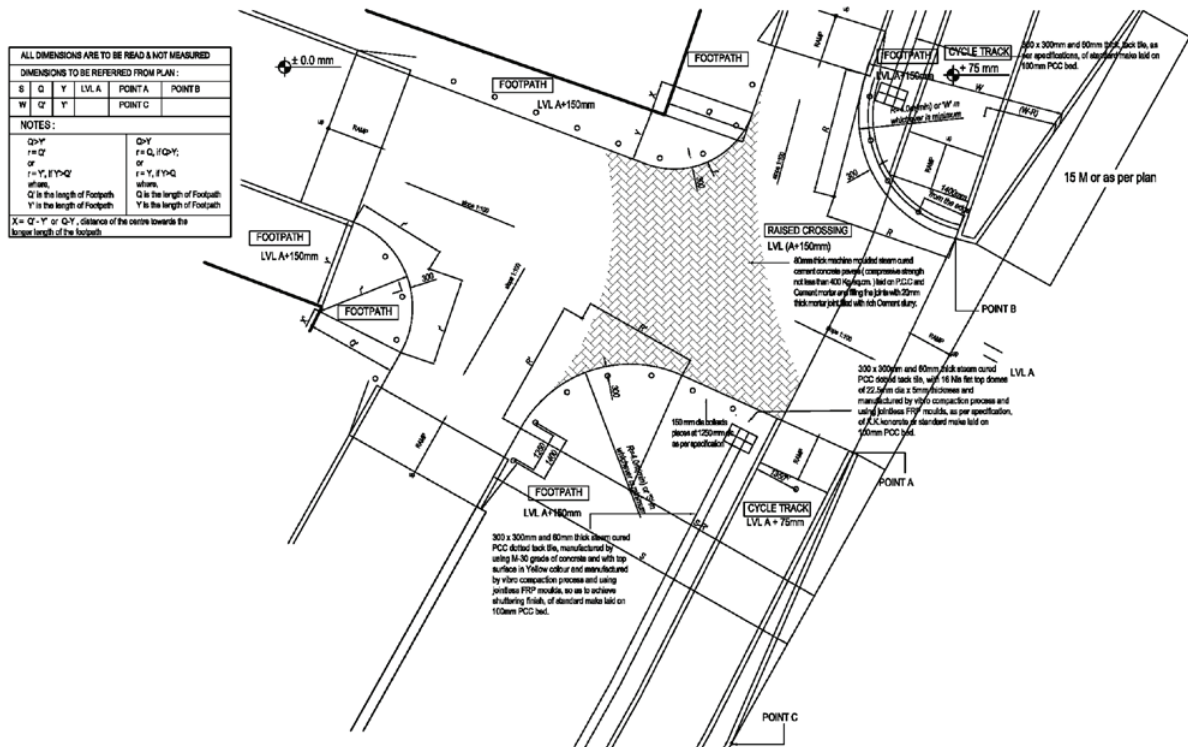

3.7.8 Material Selection – Criteria

Asphalt	
<p>The properties of bitumen such as its workability, strength, durability, imperviousness and adhesion make it an attractive material. Again, the relative economy of bitumen is undoubted as a binder; indeed its main virtue is that it is the cheapest durable glue available. Bitumen mainly acts as glue; it binds the aggregate used in the base material. It is largely nonvolatile and insoluble in acids and alkalis. The viscous properties of bitumen should be such that it is sufficiently fluid to permit handling during construction, sufficiently viscous at high pavement temperatures so that it will not permanently deform under traffic and sufficiently fluid at low temperatures. However, it requires re-layering and maintenance.</p>	
Advantages	Disadvantages
<p>It is the most appreciated by cyclists. Closed surfacing Optimal evenness Heavy traffic loads can be attended. Cheaper than concrete paving</p>	<p>Bitumen becomes soft in high temperatures and adhere to bicycle tyres (CROW, June 2007) There are chances of potholes. Foundation provided should keep heavy traffic in mind Less or no residual value. It needs to broken up into granulate and used as a secondary high-grade raw material.</p>
Concrete	
<p>In road making, concrete is used to produce a continuous relatively stiff slab (a rigid pavement). The most important mechanical property of concrete is its unconfined compressive strength after 28 days, which is usually discussed in terms of its minimum value. The initial sealing of an unbound pavement will reduce the range of moisture content that can be expected to occur within it and will protect the pavement materials from damage due to traffic, wind and water erosion. From the user’s viewpoint (cyclists), sealing provides a better driving surface and dramatically reduces the effects of dust and mud. These should surely be weighed against the cost of providing and maintaining a sealed surface. The preferred finish is broom finish required for cycle tracks to complement skid resistance. Closed surfacing can be continuously modified to load bearing capacity of the sub grade.</p>	
Advantages	Disadvantages
<p>Preference by cyclists – greater evenness – least resistance – most comfortable Not much problem with skid resistance Chance of potholes is minimal. Better than asphalt Bicycle friendly Durable Less or no maintenance required Least affected by tree roots Can easily take heavy traffic load. Long, low maintenance service life.</p>	<p>Joints must be installed carefully. On laying a concrete track special attention should be paid to shrinkage and expansion joints. Rolling resistance is higher than asphalt High cost laying More expensive than asphalt paving. Less or no residual value. It needs to broken up into granulate and used as a secondary high grade raw material</p>
Paver blocks	
<p>This is one of the most preferred materials for road managers because of its ease of use and its modular nature. However, special care should be taken while laying the material since one needs very good base and special equipment for vibrations to make it competitive with the closed surfacing materials. Also, if there is a possible maintenance required in the same, it loosens the material and affects the riding quality due to unevenness. This needs to be re-laid and the acceptable riding quality is difficult to achieve. It should be laid on sub-grades with good bearing capacity. The thickness of tiles should not be less than 60mm. Areas where heavy load is to be kept in mind should have tiles of minimum thickness of 80mm. Kerb should be added to prevent edges and joints.</p>	
Advantages	Disadvantages
<p>Poor evenness as compared to closed surfacing If the tile texture is good, it ensures sufficient skid resistance. Preferred by cable and pipe managers. Good residual value</p>	<p>Poor evenness as compared to closed surfacing since there are more joints. Clinker bricks worse than modular paving Extra care in drainage required. In case of lose joints, the water seeps in and washes away the sand affecting the evenness of the tiles. This affects the riding quality, safety and comfort.</p>
Clinker Bricks/ quartzite stone	
<p>It is similar to tiles but is less favorable by the users due to its bad riding quality and affects the safety and comfort of bicyclists. It should only be used in exceptional circumstances. If used in recreational areas, the riding comfort and skid resistance are below standard affecting the safety and comfort of the cyclists.</p>	

Advantages	Disadvantages
Appearance can increase the urban quality of the space.	Need to be laid tightly. Kerbing is preferred for better results, therefore increase in cost Not recommended in main cycling routes. Only to be used in areas of heritage. It should be given the least priority over asphalt or mixing another color.
Coloring of Bicycle lanes	
Colored concrete is costlier than ordinary concrete and this is imparted to concrete mainly by using colored cement, or even by using red or pink granite with red cement. When pigment is used proper care should be taken in using it. Usually the pigment is about 10% of the whole composition and it does not contribute in any way to the strength of the concrete but weakens it. It is advisable that the cement quantity be increased to 15% when a pigment is used so that the weakening of strength is accounted for. With buff colored aggregate and gravel a pleasing effect is obtained especially if the gravel is well exposed. Never should mortar or cement be allowed to mix on colored concrete road because the stain introduced as a result cannot be removed. In Germany some of the motorways are colored dark grey by using iron oxide in the mixture of the cement.	

4 Implementation

Implementation of a cycle infrastructure development plan involves bid process, construction, operation as well as maintenance. This section covers these aspects of implementation where the bid process is covered under costing and contracting separately, while construction is covered under construction and maintenance safety, working drawings, site layout and site inspection. Operations of cycle infrastructure are discussed under the auditing sub section of this chapter.

4.1 Costing

Cycling infrastructure which forms a part of the road network may either be developed as a new system or be integrated with existing roads and streets; with the latter being a common option for existing cities and towns. When an existing road system is upgraded as a cycling friendly design, it is rarely possible to include cycling features without re-organizing other street elements such as carriageway, services, medians and edges, pedestrian paths, etc. The resultant cost of development of cycling infrastructure must account for funds required to rationalize other road elements. This would include the cost of dismantling and re-constructing different road components, as required by the design. This section provides the designer with an itinerary of components and their estimated cost, which can be expected for every kilometre development of the cycling infrastructure. The costs presented are in Indian Rupees and are based on Delhi Schedule of rates and standard market rates (in a metropolitan city) of 2005. It is important to note that these rates are indicative and cannot be applied directly.

Cycle Tracks (Table 25) : The cost of per kilometre development of cycle tracks includes all related costs such as excavation, dismantling, preparation of sub bases, backfilling, etc. The costs have been calculated for three conditions. These include a 5.0m wide independent track and 2.5m wide cycle track on both sides of new road development or on either side of an existing road; where upgradation of an existing road to a bicycle friendly infrastructure is being undertaken.

Primary Footpath (Table 26): The cost per kilometre development of the footpath along the main carriageway and besides the cycle track or cycle lane has been calculated for a 2.5m wide footpath, on either side of the carriageway and finished in 60mm thick interlocking cement concrete tiles. Along the Independent cycle track the footpath of 5.0m width is provided along one side of the cycle track.

Functional Lighting (Table 27): Per kilometre cost of functional street lighting would be as per code of practise for lighting of public thoroughfare (BIS, 1981). The cost for an independent track is based on 150 watt metal halide light sourced, with 6m high mounting, spaced at 20m centre to centre one edge of the cycle track (only a single row). The cost of lighting for cycle infrastructure along the road is based on 150 watt metal halide lamps facing the cycle track and/or pedestrian path and spaced every 20m centre to centre, while 400 watt HPSV lamps facing the carriageway and spaced at every 40m centre to centre. The metal halide light sources are mounted at 6m height whereas HPSV light sources are mounted at 12m height. The design provides for 12m and 6m poles spaced at 20m, interval centre to centre placed alternately. 12m poles have dual mounting, i.e. HPSV lamp mounted at 12m height and facing the carriageway and metal halide lamp mounted at 6m, and facing the cycle track. The light poles in the assumed design are proposed to be mounted either between cycle track and the carriageway or between cycle track and the footpath and should achieve a lighting level of average 40 lux across the cross section, with a uniformity ration of 40%. For some streets where service lanes are provided, additional light posts/sources may be required to be mounted at the edge of the carriageway to achieve the desired average of 40 lux. The cost of this additional row of poles has not been accounted for.

Table 25: Sample cost calculation for segregated cycle track

Cycle Track Development (for arterial roads, and special condition on distributory roads) Cost in Lakhs INR			
Component	Independent Track	New Road Development	Upgradation of existing road
Dismantling of existing surface and structures	0.00	0.00	1.79
Excavation	0.67	0.67	0.67
Base courses (GSB+DLC)	57.72	57.72	57.72
M40 CC pavement+pavement marking	81.55	81.55	81.55
CC Kerb stone segregator	0.00	3.60	3.60
Total	139.94	143.54	145.33

Table 26: Sample cost calculation for footpath

Development of Footpath (Cost in Lakhs INR)			
Component	Independent Track	New Road Development	Upgradation of existing road
Dismantling of existing surface and structures	0.00	0.00	4.13
Excavation	0.78	0.78	0.00
Base courses (GSB+DLC)	25.03	25.03	25.03
60mm thick CC paver blocks on sand bed	29.70	29.70	29.70
CC Kerb stone edges	7.20	7.20	7.20
Total	62.70	62.70	66.06

Table 27: Sample costing for provision of functional lighting

Provision of Functional Lighting (Cost in Lakhs INR)			
Component	Independent Track	New Road Development	Upgradation of existing road
Foundations, including excavation	4.26	0.11	0.11
Provision of new light poles, with fittings, wires, etc.	24.75	74.50	74.50
Dismantling of existing light poles	0.00	0.00	6.00
Total	29.01	74.61	80.61

Table 28: Sample costing for Storm water drainage

Provision of New Storm Water Drain - average pipe dia. of 900mm (NP2) (Cost in Lakhs INR)			
Component	Independent Track	New Road Development	Upgradation of existing road
Excavation, filling and preparation base for pipes	20.34	20.34	20.83
Laying of pipes	8.00	8.00	8.00
Development of Manholes	85.07	85.07	85.07
Provision of Gully chambers, including connection to Manholes, using 300mm dia., NP2 pipes	40.25	40.25	40.25
Total	153.66	153.66	154.15

Table 29: Sample costing for Electrical & Telephone services

Provision of services such as light poles, telephone poles, junction boxes, etc., (Cost in Lakhs INR)			
Component	Independent Track	New Road Development	Upgradation of existing road
Shifting of Existing overground services	0.00	0.00	8.80
Provision of new overground services	0.00	40.00	0.00
Provision of new underground electrical cables (both HT and LT)	0.00	261.20	261.20
Total	0.00	301.20	270.00

Storm Water Drain (Table 28): This includes per kilometer cost estimate for providing a 900mm diameter storm water drain. The drain size is assumed to be similar for all three requirements, i.e. independent tracks, tracks provided along a new road development and those provided as a part of an existing road up gradation. Cost of provision of storm water drain (as also the cost of functional lighting) has been calculated as a new drain provision even under upgradation of existing road, based on the assumption that either an adequate drainage provision may not exist, or it is an old choked drain requiring replacement. The drain pipe size is assumed based on the large distances between outfall points within the city. The drain collection system assumed for the costing is based on surface gully chambers and not bell mouths.

Electrical and Telephone Services (Table 29) : Development of cycle track along an existing carriageway may require re-location of some overhead poles and underground services related to telephone and electricity. This is based on the understanding that the electricity cables need to be accessed at the location where faults occur requiring frequent digging and trenching. These cables cannot be located under a concrete cycle track which will limit the access to such services. Poles cannot be allowed to be left within the cycle track and hence some may need to be shifted to another location. The costing for these procedures is based on the assumption that a single HT and two new LT cables may be required to be provided as an outcome of this shifting exercise on either side of the carriageway. For a new road development all services are new and hence the cost has been estimated accordingly. Since these electricity and telephone services are not directly related to cycle infrastructure but are a part of the road infrastructure they have not been accounted for in the cost of development of independent cycle tracks.

Carriageway (Table 30): The cost of development of a 6m wide, 2 lane carriageway along with 2m wide cycle lane for each direction (cost inclusive of both directions). The cost is only a part of complete road infrastructure design to make it cycle friendly and hence is not included for independent tracks. The cost for upgradation of existing roads is based on construction of roads from base courses for only 2m width for each direction. This is based on the assumption that re-alignment of the road would require limited width of the carriageway to be re-developed from the base. This is also the reason why the BC course or the top black layer may need to be removed, and re-laid to adjust the slopes and camber as per revised alignment. The cost for carriageway development for arterial roads may need to be adjusted to allow approximately 20% reduction on account of lower overall carriageway width for each direction to 2 lanes or 6.7m, as the cycle, lanes are replaced by cycle tracks on such roads.

Telecom Conduits (Table 31): Telecom conduits may be required to be provided separately under some arterial roads. These are generally located under the service road and carry optical fiber and other telecommunication cables. Such a development may be taken up to rationalize service provision along the roads when they are disturbed due to development or integration of cycle infrastructure. Since provision of telecom conduits is a part of road infrastructure it has not been accounted for in the development of independent cycle tracks.

Service Road (Table 32): Service roads are provided along arterial roads to cater to the access function of the road. The cost of development of six meter wide service roads on either side of the carriageway has been indicated. The cost for development is inclusive of base courses for new road development, whereas for upgradation of existing road, 1.5m wide development is considered with base courses.

Table 30: Sample costing for new carriageway

Development of two lane carriageway with central median and 2.0m wide cycle lane (for distributory roads only). (Cost in Lakhs INR)			
Component	Independent Track	New Road Development	Upgradation of existing road
Dismantling of existing road level footpath, and scrapping and removing top surface of existing carriageway	0.00	0.00	8.09
Scrapping/removing of top surface of existing carriageway	0.00	0.00	5.74
Carriageway, base layers upto DBM	0.00	262.47	65.62
Provision of new carriageway black top in asphaltic concrete	0.00	38.21	38.21
Development of 1.2m wide, 0.15m high central median, including excavation and finishing.	0.00	26.69	29.69
Total	0.00	327.37	147.35

Table 31: Sample costing for laying telecom conduits

Provision of 450mm dia., telecon conduit with manholes at 40m intervals (Cost in Lakhs INR)			
Component	Independent Track	New Road Development	Upgradation of existing road
Excavation and refilling, including preperation of base	0.00	2.07	3.62
Proision of 700mm x 700mm manholes, 1.2m in depth	0.00	31.27	31.27
Provision of 450mm dia., NP2, cement concrete pipes	0.00	11.00	11.00
Total	0.00	44.34	45.88

Table 32: Sample costing for Service Road

Provision fo 6m wide service lane (Cost in Lakhs INR)			
Component	Independent Track	New Road Development	Upgradation of existing road
Dismantling of existing road level footpath, and scrapping and removing top surface of existing carriageway	0.00	0.00	6.07
Scrapping/removing of top surface of existing carriageway	0.00	0.00	4.30
Carriageway, base layers upto DBM	0.00	196.85	49.21
Provision of new carriageway black top in asphaltic concrete	0.00	28.66	28.66
Development of 1.2m wide, 0.15m high central median, including excavation and finishing.	0.00	20.01	22.26
Total	0.00	245.53	110.51

Secondary Footpath (Table 33): Secondary footpaths are located at the edge of the ROW along the service lane on an arterial road. These only exist on an arterial road with service lanes, as on other streets the primary footpath is at the edge of the ROW. These may require to be developed as a part of the service lane development along roads where cycle infrastructure is included.

Sign Boards and Pavement Marking (Table 34): Pavement marking and sign boards are required both for cycle tracks as well as carriageways. The cost for road safety provisions for independent tracks as well as cycle infrastructure along the carriageway has been indicated. This does not include provisions for service lanes. The cost of pavement marking for cycle lane and cycle tracks have been shown separately. This is because cycle tracks include cycle box marking repeated every 100m which is not required for a segregated facility. The cost indicated is for development of a 2.5m wide footpath along the service lane on either side of the carriageway. The height of the footpath should be 0.15m.

Landscaping and Miscellaneous (Table 35): Plantation and landscaping elements are not only essential to ensure a good riding experience, they are necessary to protect the rider from harsh climatic conditions in most parts of the subcontinent. The cost estimate for new tree plantations, shrubs, grass, planters, benches, bollards, blinkers etc has been provided. The cost also includes provisions for changes in paving material at plazas etc.

Overall Road and Cycle Infrastructure Development Cost (Table 36) : The analysis of individual component cost for streets with integrated cycle infrastructure reveal that integration of cycle specific infrastructure in a road development project only amounts to 10% of the overall road development or improvement cost. The analysis also highlights the issues that under current circumstances, most roads in the Indian subcontinent require an investment almost equal to development of new streets to upgrade them to cycle and pedestrian friendly roads as per current best practices and international standards. The approximate cost of development of new and upgradation for existing cycle friendly and integrated infrastructure has been provided.

It is important to note that though the above mentioned costs cover most items required for a street development they may not be complete. For example it does not include the cost for development of bus shelters, traffic signals, traffic calming measures (including raised crossings), cost of construction, safety equipment, etc.

4.2 Contracting

The contract document between a contractor appointed for the development of a cycle infrastructure, and the employer (such as the municipality or state department) is a legal document listing the scope of services of the contractor including details such as development drawings, bill of quantities, cost estimate, specifications, time lines, etc. It includes clauses required to define the quality control and monitoring of the work. The contract document is generally based on the format specified by individual municipalities or state department, and such local administrative requirements are reflected in the general conditions, clauses and forms of the contract. In addition, the contract document has a provision for the insertion of special conditions. These conditions allow the employer to define work specific, legally binding instructions for the contractor in the document. Employers should use these conditions to include references and compliance with construction safety guidelines, quality management procedures, etc. Examples of some of the important instructions that should be included in a contract promoting NMT infrastructure development are:

- The contractor shall use digital total station equipment and related devices for layout of all construction points/plan/profile at site. Readings from the same should also be used for all measurement purposes, both for quality inspection and billing.
- The contractor should refer and comply with NHA work zone safety manual as well as the additional safety instructions included in this document. The costs of all specific safety related equipment, material and workforce as required by these documents and instructions have been accounted for in the bid price. The procurement and use of such equipment, material and workforce by the contractor should not be effected by any change, addition/alteration or modifications in the contract items or implementation plan.

Table 33: Sample costing for secondary footpath

Development of Service Lane level Footpath (Cost in Lakhs INR)			
Component	Independent Track	New Road Development	Upgradation of existing road
Dismantling of existing surface and structures	0.00	0.00	4.13
Excavation	0.00	0.78	0.00
Base courses (GSB+DLC)	0.00	25.03	25.03
60mm thick CC paver blocks on sand bed	0.00	29.70	29.70
CC Kerb stone edges	0.00	7.20	7.20
Total	0.00	62.70	66.06

Table 34: Sample costing for provision of Sign Boards & Markings

Provision of Sign Boards and Marking (Cost in Lakhs INR)			
Component	Independent Track	New Road Development	Upgradation of existing road
Information Boards	0.6	12.0	12.0
Regulatory and Warning sign boards	0.0	0.6	0.6
Pavement marking for motor vehicle lanes	0.0	5.1	5.1
Reflector studs or audible warning devices	0.0	3.0	3.0
Spring Posts/ Plastic bollards	0.0	1.3	1.3
Pavement marking for cycle tracks	13.7	0.4	0.4
Pavement marking for cycle lanes (distributory roads only)		25.0	25.0
Total	14.3	47.4	47.4

Table 35: Sample costing for Landscaping & Miscellaneous provisions

Landscaping and Miscellaneous items (Cost in Lakhs INR)			
Component	Independent Track	New Road Development	Upgradation of existing road
Including new tree plantation, shrubs, grass, etc. (inclusive of preparation of soil, beds, etc.)	2.52	2.52	2.52
Benches, solar blinkers, ramps, tow walls, etc.	5.00	15.00	15.00
Total	7.52	17.52	17.52

Table 36: Sample costing for overall development of NMV infrastructure compared to cycling facility

Development per km (Cost in Lakhs)			
	Complete Road with Cycle Facility	Complete Road without Cycle Facility	Difference of Cost
Arterial Road (45m ROW)			
New Development	1390.08	1246.18	143.9
Upgradation of Existing	1096.38	950.69	145.69
Distributory Road (24m ROW)			
New Development	984.45	959.45	25
Upgradation of Existing	783.07	758.07	27
Local Road (12m ROW)			
New Development	512.67	512.67	0
Upgradation of Existing	381.5	381.5	0
Independent Tracks			
New Development	407.08	139.94	267.14
Upgradation of Existing	-	145.33	-

4.3 Safety during Construction and Maintenance

Safety of cyclists and other road users need to be taken into consideration at the time of road construction and maintenance work. This includes works done for road restorations. At times of construction, the cyclists share the carriageway with the on-going construction work and they need to be provided similar safety practices for other users; at times of maintenance (since usable cycle infrastructure is occupied) cyclists need to be provided alternate/temporary facilities in lieu of occupied infrastructure. Although IRC SP 55 safety during construction has been outlined, cyclists have not been given due importance in the guidelines. The Work Zone Safety Manual (NHAI, 2010), addresses safety at work zones for all road users including vulnerable road users, however the document is specific for application on highways, and may not be entirely applicable in urban areas.

4.3.1 During Construction

The speed of a construction zone is specified and maintained at 30 km/hr for all traffic. Specific provisions for cyclists such as segregation from motorized traffic may not be necessary. The contractor should submit a detailed safety goal and safety case, to the employer. A safety goal lists targets for achievable work zone safety, while safety case includes a detailed safety plan required to achieve the said safety goals. A safety plan should be a supplementary plan for the construction work to be taken up. Usually, construction in roadway is taken up in segments or stretches. Thus planning of safety provisions in the work zone roadway needs to be undertaken in coordination with the construction phasing and traffic management plan. It is advisable to make a phase-wise description of the construction work plan, in which, planned interference in the moving vehicular/ pedestrian traffic especially near bus shelters and footpaths are defined. The process of ensuring safe work zone conditions is divided into three stages (i) Before start of work (ii) During execution and (iii) Partially completed section.

Need of Traffic Management Plan (TMP): The primary purpose of the Work Zone Traffic Management Plans (WTMPs) is to provide for the reasonably safe and efficient movement of road users through or around the work zones while reasonably protecting the workers and equipment. When the normal function of the roadway is affected with the presence of workers and equipment, the WTMP provides for continuity of the movement for motor vehicle, bicycle, and pedestrian traffic, transit operations, and access to properties and utilities. (SP:55, 2013). The traffic management plans should be prepared by the contractor before the start of the work (Figure 38). They need to be approved by the engineer. Also, later they need to be checked on site. Warnings must be issued if compliance is below 80% and work must stop if compliance is found to be below 70%. (NHAI, 2010). It often happens that partially completed sections are opened for traffic operations. For such situations, temporary signages and markings may be resorted to.

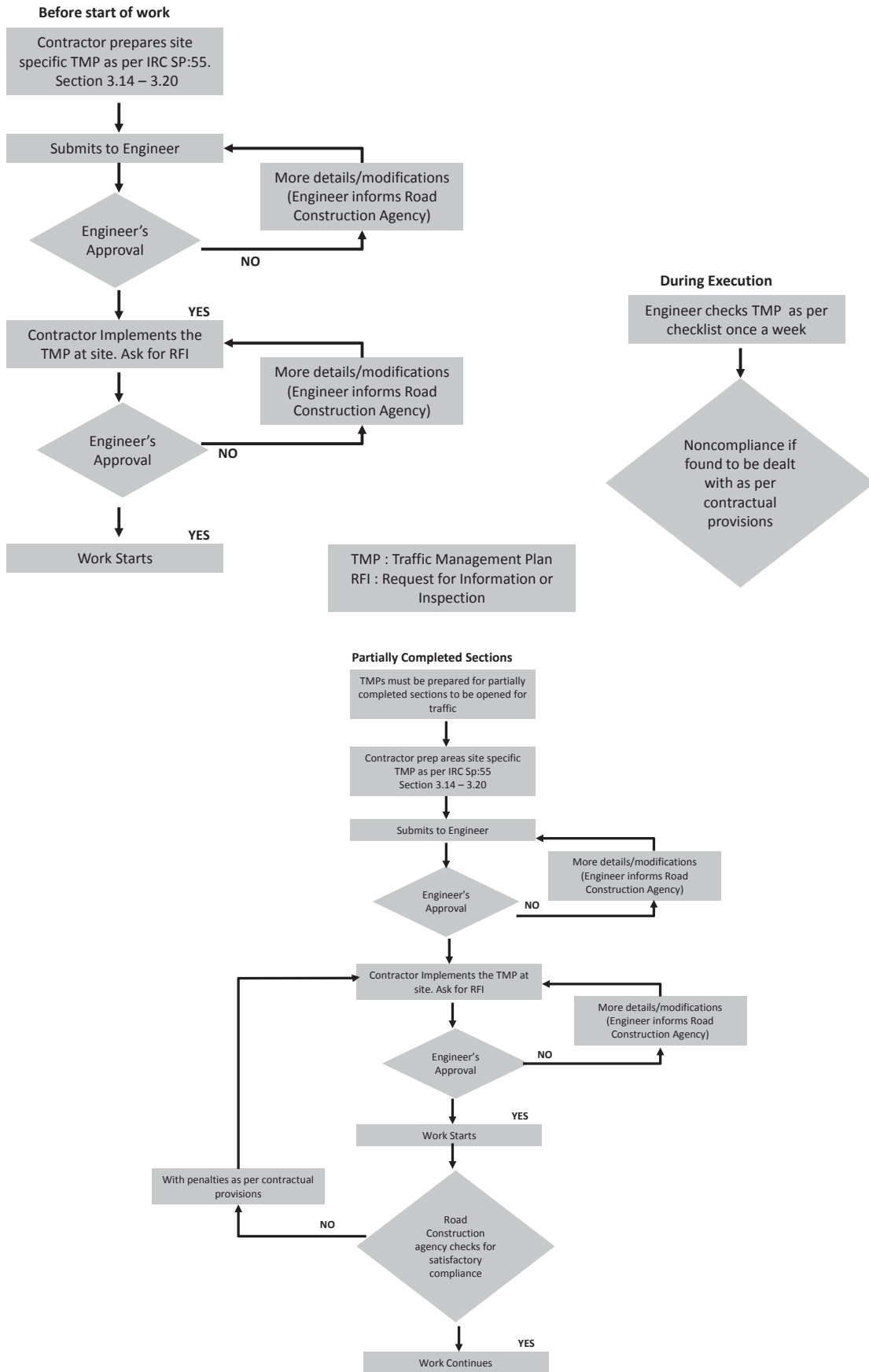

Figure 38: Traffic Management Process for Construction Zones (NHA, 2014)

There are five phases of traffic control:

1. **Planning Phase:** To identify and include traffic control requirements in the contract specification, work program and method of construction.
2. **Design Phase:** To design the Traffic Management Plan in detail, with regard to types, location and layout of traffic control devices for submission to the road authority for approval.
3. **Implementation Phase:** To install the temporary traffic control devices safely in accordance with the approved Traffic Management Plan.
4. **Operation and Maintenance Phase:** To inspect the Traffic Management Plan and devices regularly by day and night to ensure that they are effective and absolutely safe.
5. **Close out Phase:** To remove all the traffic control devices safely and reinstate the permanent traffic scheme.

The Traffic Control Zone (Figure 39) is the area of the road which is affected by the construction works and affects traffic flow and road users. The Traffic Control Zone can be divided into four components: the Advance Warning Zone, the Transition Zone, the Work Zone, and the Termination Zone. It is important to note that construction activity can change a part of the site ready for movement/usage by traffic, in a matter of few days. This should be accounted for in the traffic plan and the safety plan and zones re-designated in line with construction phasing.

Advance Warning Zone: The purpose of this zone is to warn and prepare the road user for the change in driving conditions (due to construction activity) ahead. To achieve this, presence and extent of the hazard through “Road Works Ahead” sign, accompanied by the distance to the hazard. Any changes affecting traffic arrangements (such as a reduction in the number of lanes and/or in the speed limit) within the traffic control zone should be notified. The type of danger should be indicated. In this zone it is also important to notify the reduction in speed of the vehicles, by using signboards. **The speed should not go beyond 30km/hr.**

Transition Zone: Moving zone or Transition zone is generally not affected by construction activity and serves the function of physically reducing vehicular speeds to the construction zone speeds through the use of adequate traffic control devices. Before declaring an area as a moving zone, it should be ensured that the disturbed services (during any preceding construction phase in that zone) such as streetlights etc are reinstated maintaining lux levels (in line with IS codes). At off peak hours (additionally) temporary narrowing of the lanes may be required so that drivers cannot speed more than 30km/hr in designated stretches. As a suggestion, intermittent barricading should be taken up so that only one lane should be operative at night. This can be undertaken using cones and with retro reflective tapes. It should be ensured that all debris, construction material, equipment, vehicles etc. are removed from the defined moving zone and its periphery before declaring the area usable. Any kind of landscape/trees obstructing the movement, physical or visual should be highlighted using retro-reflective tapes and safety cones, wherever necessary.

Work Zone: Work zone or construction zone is the area where the construction activity is undertaken. Speed of the moving traffic in this zone shall continue to be limited to 30km/hr. Traffic path in this zone must be delineated through the traffic control zone to prevent high speeds in this area. The contractor/PMC should define the area for construction, including additional space required for the safe movement and operation of equipment, manpower and other provisions such as any storage yards etc. The selection of an area as construction zone at any time should ensure enough space for safe and conflict free movement of traffic (as per overall traffic plans for the site), including non-motorized traffic and pedestrian which shall be adequately segregated from motorized traffic movement.

NOTE : This drawing is a graphical representation of the detour setup. It is not drawn to scale

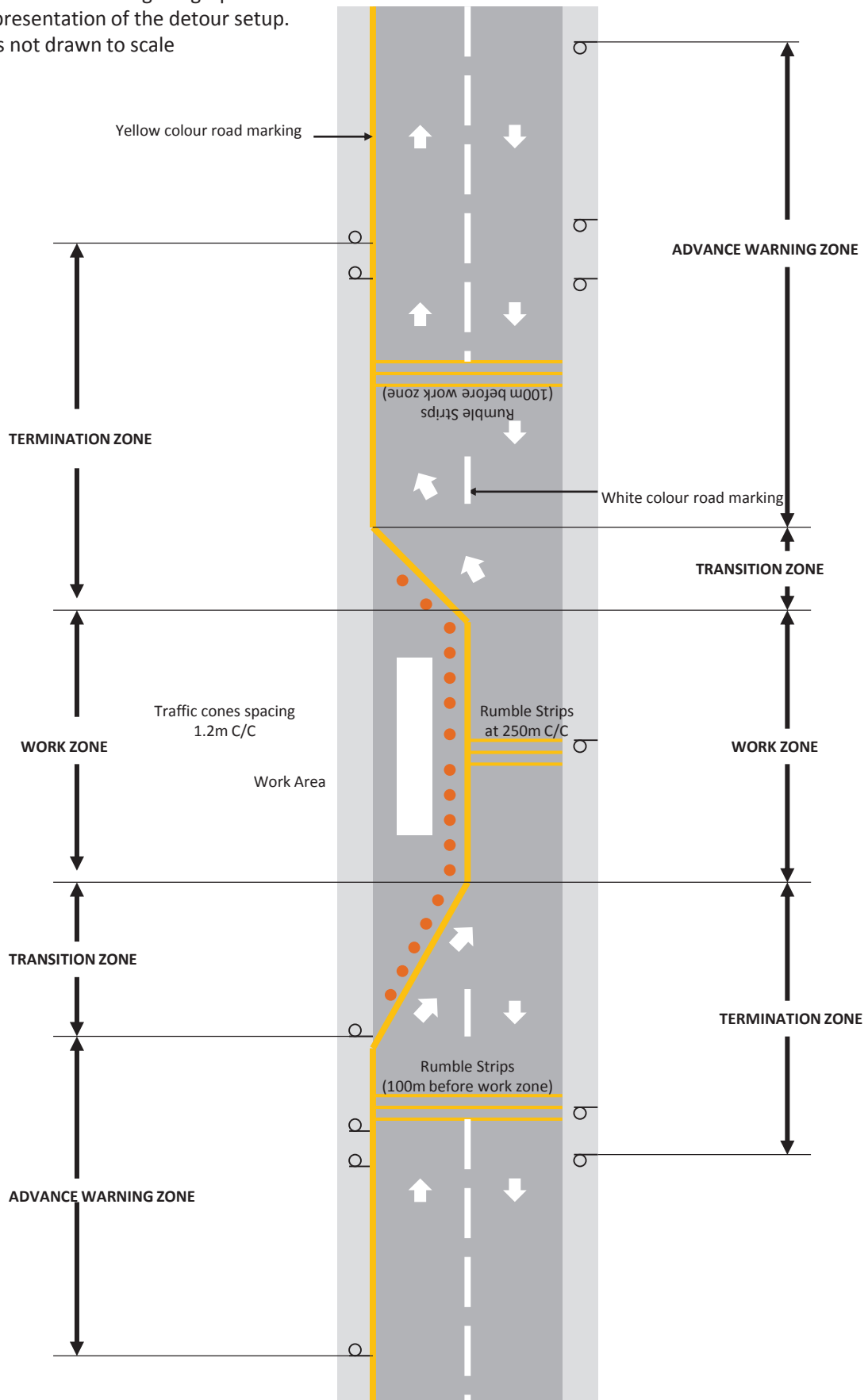

Figure 39: Elements of Traffic Control Zone (NHAI, 2014)

Termination Zone: The culminating end is called the Termination Zone. To ensure smooth and conflict free movement of traffic, it is advisable to use Advance-Warning signs at the initial and culmination areas of the transition zone. Additional protection using safety cones should be taken up, where required. Speed of motorized vehicles in this zone should be controlled to a limit of 30km/hr using adequate traffic control devices.. Pedestrians should be segregated from motorized traffic.

Traffic Control Devices : Traffic Control (TC) devices include appurtenances such as signs, signals, flashers, delineators, markings, barriers and other devices used to regulate, warn, or guide road users, and they should normally be placed on, over, or adjacent to a street, highway, pedestrian facility, or cycle track by the person responsible for managing the traffic operations efficiently and safely in the work zones. (SP:55, 2013). Traffic control devices are broadly classified into three categories,

- Road Signs
- Channelizing Devices
- Lighting Devices & Variable Message Signs

Signs (Figure 40): The road construction and maintenance signs are desirable to aid driver’s comprehension of the route through the road works. For all roads works except on access controlled highways, the sheeting for ground mounted signs to be used in WTMPs should be of CLASS B sheeting, i.e. High Intensity and High Intensity Prismatic grade sheeting as per ASTM D 4956-09 Type III and IV, as given in IRC 67 2012. The placement of the signs should be in accordance with the TMP with vertical and lateral clearance. IRC SP:55 indicated the lateral and vertical clearance of various signs.

Channelizing Devices: They are used to warn the road users of the work activity in advance and guide them. These include cones (Figure 41), tubular markers, vertical panels, drums, barricades, and pavement markings and road studs. Barricades can be portable or permanent. Barricades prevent traffic from entering work areas, such as excavation and material storage sites, provide protection to workers, separate two-way traffic and protect construction work such as false work for culverts and other exposed objects. Sandbags (painted yellow in colour) could be used at the back of the moveable barricades to add stability and rigidity. Traffic cones may be used to channelize road users, divide opposing vehicular traffic lanes, divide lanes when two or more lanes are kept open in the same direction, and delineate short duration maintenance and utility work. All pavement markings should be in accordance with IRC-35. Pavement markings should match the markings in place at both ends of the work zone. Pavement markings should be placed along the entire length of any surfaced detour or temporary roadway prior to the detour or roadway being opened to road users. Various other channelizing devices have been discussed at length in IRC:SP 55.

Lighting Devices & Variable Message Signs: Lighting devices may be used to supplement retro-reflectorized signs, barriers, and channelizing devices. During normal daytime maintenance operations, the functions of flashing warning beacons may be provided by high-intensity rotating, flashing, oscillating, or strobe lights on a maintenance vehicle. The primary purpose of portable variable message signs in work zones is to advise the road user of unexpected situations. Portable variable message signs should be visible from 800 m under both day and night conditions. (SP:55, 2013)

Marshals (Figure 40): Marshals are employed by the contractor and play a crucial role in controlling the traffic through work areas. They use hand held signalling devices such as flags and sign paddles, to control and direct traffic. Since Marshals are responsible for human safety, it is important that qualified personnel be selected. The use of yellow vest and/or yellow cap is desirable for marshals. At work sites, he is expected to stop traffic intermittently and to maintain continuous traffic near a work site at reduced speeds, to help in protecting the workmen. For both functions, the marshal must, at all times be clearly visible to approaching traffic for a distance sufficient to permit proper response by the drivers to the flagging instructions and to permit traffic to reduce speed before entering the work site. This sight distance in urban areas should be from 20m to 50m. Marshals can be of additional help in guiding cyclists and pedestrians through the construction zone.

All of the above have been discussed in detail in IRC: SP 55, Guidelines on traffic Management at work zones. A description of measures to be taken for vulnerable road users has been added in the annexure.

Shape & Color Pattern Signs in WTMP				
Category	Shape	Color	Shape	
Regulatory/ Mandatory	Normal Regulatory (INR) Signs	As in in IRC 67:2012	Circular	
	Worksites Regulatory (WR) Signs	Red & White	Rectangular	
Warning	Normal Warning (NW) Signs	As in IRC 64:2012 But in Yellow Background	Triangular	
	Worksites Warning (WR) Signs	Black & Yellow	Rectangular	
Informatory	Workzone Information (IS) Signs	Black & Yellow	Rectangular	
	Workzone Direction (IS) Signs	Black & Yellow	Rectangular	



Figure 40: Signs used in WTMP (L) Marshals on work site (R) (SP:55, 2013)



Figure 41 : Use of channelizing devices during construction. (Source: SGArchitects,Delhi)

4.3.2 Safety during Maintenance

Safety during maintenance and construction require different approaches. In case of maintenance works, the infrastructure for the cycle users is already in place with all the required services and safety features. Maintenance/ Restoration task in and around the existing cycle infrastructure should cause a minimum of disruption in the movement of cyclists. For major maintenance works, the methodology of the implementing safety features is similar to that of the safety measures to be taken up during construction. For minor works (such as cleaning and repair) the contractor should ensure the use of visible temporary barricades and signs to direct cyclists to a temporary path. If cyclists are required to merge with motorized vehicles in the maintenance zone, adequate speed control provisions should be applied in motor vehicle lanes (for the duration of the maintenance work), to ensure cyclist safety.

4.4 Site Supervision

The importance of quality of bicycle infrastructure in ensuring and attracting usage has been highlighted in previous sections. It is evident that such high quality cannot be achieved without introducing adequate processes and supervision during construction. This section discusses some of the key components of construction supervision. Table 37 suggests a step by step procedure for the same.

Preparation of Construction/Working Drawings : It should be taken up at the design end making sure that all alignments and design details are done on the total station system and not moved, since each point on the drawings refers to a location on site as per the co-ordinate system of the drawing. Turning or rotating a drawing within the co-ordinate system would remove those references making it impossible to use the drawing for layout at site using total station systems. Planners/designers should produce a set of key guidelines as instructions for people implementing and executing the design. Transfer of a well-conceived NMT infrastructure plan on site, demands good communication between design agency, project managers and the contractors in order to explain and interpret the drawings. All drawings should be well referenced with the detailed drawings including signage and marking designs. They can also be made to suit the various contractors employed like civil, electrical, drainage, etc.

Project Manager and Quality Surveyor: Apart from assisting the employer in quality control and billing, the role of project manager (PM) is to ensure that there are no discrepancies during the process of transfer of drawings to site. PM ensures two way communications between designer and the contractor. Any kind of discrepancy or observation at site, in relation to an obstacle to work should be reported by contractor to the PM for a consultation with the design team.

Site Layout and Inspection: Accurate site layout of digital working drawings of an NMV facility is critical to accurately replicate design features essential for ensuring usability and safety. Given below is a brief step by

Site Inspection Procedures : At all stages of construction, there should be no compromise of safety of the road users as well as the workers on site. There should be periodic inspections to maintain the quality of the project execution.



Figure 42 : Cyclists move with other traffic in the traffic control zone during construction. (Source: Delhi)

Table 37 : Step by Step procedure adapted for working drawings at site.

STEP PROCEDURE WHICH MAY BE ADOPTED FOR LAYOUT OF DRAWINGS AT SITE	
1	Design elements from plan and its relative co-ordinates should be used to mark the layout of cycle track, MV lane and service lane on site.
2	Co-ordinates of proposed manholes and the drain centre line should be used to layout any new drain to be constructed on site (as paint marking). It should be verified at this stage that the alignment of the drain viz-a-viz the civil layout is accurate.
3	Tree plan provides list and location of all trees that need to be cut or transplanted at site, including their girth (as co-ordinates in the tree excel table provided along with the drawings). If the site engineer feels that minor changes in the civil and/or drain layout can result in saving some trees the same should be brought to the notice of the designer and a site meeting fixed to resolve the issue. Trees marked for transplantation should also be moved to their new positions (as marked in the table given along with the plans) at this stage after verifying with the forest department that the tree is fit for transplantation (if not the tree is marked for cutting).
4	At this stage the electrical and the drain contractors should lay their cables and underground drains as per co-ordinate information given in the drawing read along with finished road levels provided by profile designers. All locations of manholes should correspond with the drawing using co-ordinate information derived from digital drawings.
5	If site constraints require any electrical and or drain fixture to be shifted (including those affecting drain layout), the same should be brought to the notice of design consultants and a site meeting organized to take relevant decision. In case changes are decided the contractor should provide the design consultant the co-ordinates of revised drain layout, manhole location, etc.
6	After laying all cables, pipes etc. for drain and electrical connections, the electrical and drain contractors may give a go ahead for civil layout on site. In case any changes have taken place in drain or electrical layout the contractor shall take the revised drawing from design consultant for implementation at site.
7	The revised civil drawings along with co-ordinates should be used to layout the alignments on ground using paint marking. The same should be checked by design consultants/engineer in-charge.
8	After verification that the layout is fine the contractor may lay his curbstones/retaining walls etc., as per working cross-sections, FRLs and typical details submitted to him. All TSR parking areas, entrance exit to service/ side road, cycle rickshaw parking junctions etc. have to be constructed strictly as per detailed drawings submitted. If the same is not possible due to site constraints it should be brought to the notice of design consultants/engineer in-charge for necessary action.

4.5 Audit & Benchmarking

4.5.1 Auditing

Audits can be used in any phase of project development from planning to construction. The main aim of an audit is to minimize the risk and severity of road crashes; to minimize the need for remedial works after construction; and to reduce the life costs of the project (Austroads, 2002). It is intended to minimize the risk of a traffic crash and ensure that measures to eliminate or reduce identified urban roadway problems are fully considered. In auditing NMT cycle facility is important to understand the overall functioning of the provided infrastructure. It informs the need to upgrade and maintain certain areas that lead to better functioning and safety. An audit case may refer to city, station area network, route or corridor etc. as the cycle infrastructure cannot exist or be planned in isolation.

1. City Level – For a city level audit, a sampling methodology needs to be undertaken. In the “Toolkit for preparing Low-carbon Comprehensive Mobility Plan (UNEP, 2012), a sampling methodology was undertaken to evaluate a city. A sample should include about 10% of the entire road network of the city covering all type of roads. In LCMP (UNEP, 2012), the city can be divided into 6-8 broad zones based on land use patterns and distance from the city core area (CBD). This captures variations in infrastructure as well as variations in socio-economic profiles of city residents (Table 38). The sampling methodology needs to be applied for household surveys and information about infrastructure inventory.

a. Sampling technique for household surveys: It is required to have a representative sample survey from all the sections of society. From the broad zone categories defined, sample TAZs are selected for surveying and collecting data. A stratified sample is done based on the socio-economic construct of the city such that it is significant at the level of 95% confidence interval. Detailed description of the methodology is given in Annexure 1 at the end of survey formats. (Ref 4.6.2)

b. Sampling technique for collecting data related to infrastructure: Infrastructure inventory is to be prepared collecting information about the existing levels of service and types of infrastructure. Data on roads and infrastructure type is collected for three categories of roads defined as – Arterial or sub-arterial; Collector roads and Local roads based on the ROW and the purpose served. The road inventory for the entire city is developed on GIS platform and using a sample of roads data regarding the amenities and facilities is collected. (Ref 4.6.2)

From each of the broad category of zones as defined, sample TAZs are selected based on their spatial distribution. From each of the TAZ selected, detailed survey is conducted on 30 - 40 randomly selected roads. Based on the land use characteristic and spatial distribution of TAZs a relationship can be drawn to extrapolate the infrastructure type in the city. The audit checklist for the city is given in annexure 4.6.3.

2. Corridor/Route - When a corridor or route is desired to be audited, the audit can be conducted for cycling infrastructure independent of the context or in relation to the context. In the Urban Road Safety Audit Toolkit (MoUD, 2012), the audit selection is based upon road type and context. In this, 3 different points of view (pedestrian, cyclist and motorised vehicle) for each of these roads will be integrated with 12 identified indicators (Figure 43). The sample checklist for the cyclist has been added in annexure 4.6.4. Such a checklist should be used for a planned or an already existing facility. The audit assessment was given a score and the various road were given a weightage to get a net performance score for the type of road. Another type of audit was taken up by Parisar to assess the cycle tracks in the city of Pune (Singh, 2011). This was specific to the construction of segregated cycle tracks in the city of Pune and focused upon safety, continuity and comfort of the provided infrastructure. The route was broken into segments (~ 500m). A list of indicators for the above three parameters has been described and scored on the basis of a penalty point system.

Table 38 : Broad Categories of Zones (UNEP, 2012)

Distance from CBD	Residential	Slums	Commercial/industrial
0 -1 km			
1 – 3 km			
3 – 5 km			
more than 5 km			

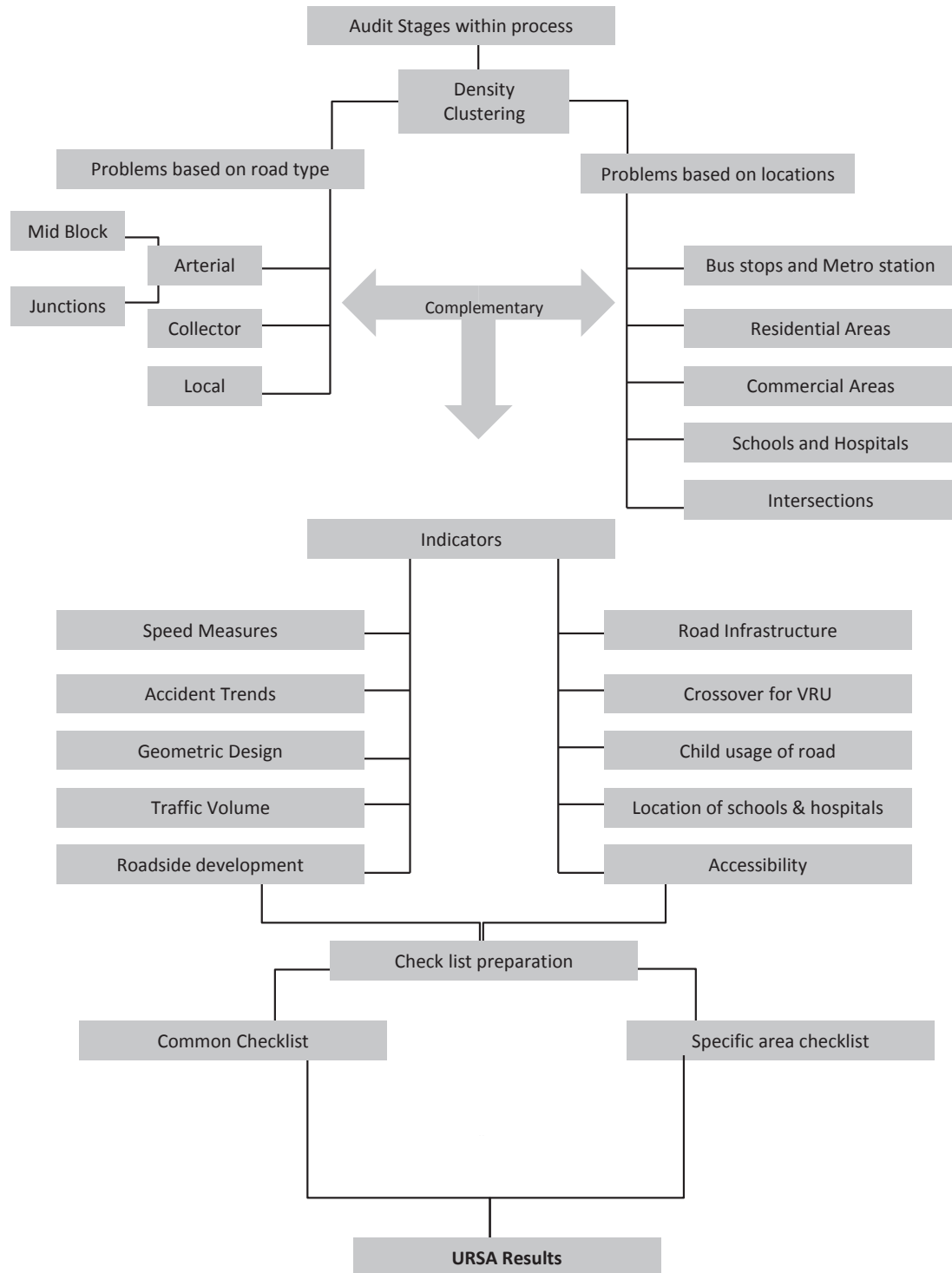

Figure 43 : Road audit methodology adopted by Urban Road Safety Audit (URSA), (MoUD, 2012)

3. Transit Stops – Transit stops (Bus, MRTS, BRTS) when introduced on the edge of the road, affect the natural path of a cyclist. There are special conditions where the geometric alignment needs to be well designed, not compromising the pre-requisites of NMT infrastructure. The Public Transport Accessibility Toolkit ((MoUD), 2012) can be conducted either during the construction of a new public transport facility or in redesigning an existing facility. It is necessary to understand different access modes and plan for each and every one of these and potential access modes to ensure accessibility to PT. This helps in identifying the access modes for which intermodal connectivity need to be provided in Indian cities. 5 types of modes were thus identified as pedestrian, cyclists, IPT users, bus users and private motor vehicle users. The area in which the audit has to be carried out is dependent on the type of road user. Access area to the public transport stop for different types of road users is calculated in Table 40. There are 8 checklists included out of which one addresses accessibility to cyclists. The checklist has been added in annexure 4.6.5.

4.5.2 Benchmarking

Benchmarking is used to evaluate the performance of the provided infrastructure. It can help Urban Local Bodies (ULBs) and other agencies in identifying performance gaps and effecting improvements through the sharing of information and best practices, ultimately resulting in better services to the people. Ministry of Urban Development has come up with Service level Benchmarks for Urban Transport. These also include NMT facility. Typically, four levels of service (LoS) have been specified: 1, 2, 3, and 4 with 1 being highest LoS and 4 being the lowest to measure each identified performance benchmark (Figure 44). Therefore, the goal is to attain the service level at 1. The scope of the survey is not complete with all types of roads. This has some shortcomings for a city wide sampling and has been highlighted in Table 39.

Table 39 : Survey required for NMT facility.

Service Level Benchmark (SLB)	Area to be covered	Primary Survey Required
Non-motorised Transport Facilities (NMT)	Arterial roads / sub arterial roads/key public transport corridors.	Dedicated NMT track having minimum width of 1.5m or more.
		Measurement of parking area on dedicated cycle track.
		Signalised intersection count.
Comments		
	The above requirement does not sample a city. Distributor and access roads need to be included.	The minimum width of 1.5m for a cycle track is not acceptable. Also, the integration of bicycle parking at locations should be measured.

All JNNURM cities have been advised to use SLB's and assess the performance. The indicators and their shortcomings are mentioned in Table 41.

LCMP (UNEP, 2012) has highlighted a list of indicators for low carbon transport out of which the following can be enlisted for cycling. They have been added in Annexure 4.6.4. Usually all the audits score the indicators against some weightage to assess the performance of the undertaken infrastructure. Especially for a corridor or a transit stop, it is beneficial to assess the principles of planning and design against a set of derived indicators. There hasn't been much work in benchmarking due to the absence of good NMT infrastructure. However, Figure 45 - Figure 49 shows weightages against the principles of design for NMT. This can be used while evaluating a corridor performance. An audit and performance assessment of various cycle corridors/segments can verify the parameters, indicators and their mentioned weightages.

Table 40 : Access area to the public transport stop for different types of road users ((MoUD), 2012)

Type of Road User	City Bus System	Mass Transit System (Metro/BRT) in m
Pedestrian	300 - 500	
Cyclist	1000 - 1200	2000 - 2500
Auto	1500 - 1800	3000 - 3500
Bus	~= 2000	~= 4000

Indicators to calculate city wide Overall Level of Service (LoS) of NMT facilities			
LoS	1. % of network coveredw	2. Encroachment on NMV Roads by Vehicle Parking (%)	3.NMT parking facilities at interchanges (%)
1	>=50	<=10	>=75
2	50-25	10 - 20	50-75
3	25-15	20 - 30	25-50
4	<15	>30	<25

Overall Level of Service (LoS) of Non Motorised Facilities (NMV) City-Wide		
The calculated level of service (LoS) of Non Motorised facilities is = (LoS1+LoS2+LoS3) and identify overall LoS as mentioned below		
Overall LoS	Calculated LoS	Comments
1	3 - 5	The city has adequate NMT facilities at overall road network
2	6 - 8	The city has NMT facilities which may need some improvements in terms of encroachments, parking facilities at interchanges, etc, as some parts of the city are not served by it. The system provided is comfortable and sustainable.
3	9 - 10	The city has NMT facilities which may need considerable improvements as many parts of the city are not served by it.
4	11 - 12	The city lacks adequate facilities

Reliability of measurement	
Reliability Scale	Description of method
Lowest level of reliability	Based on some information collated from secondary sources
Intermediate level (C)	Only information collected from city authorities/different agencies without any checks
Intermediate level (B)	Only surveys are undertaken
Highest / preferred level of reliability (A)	All the data for the above mentioned parameters is collected/measured as mentioned above. Field observers should be properly trained, data formats provided, and observations be properly tabulated. Population data should be from census records. Actual surveys are undertaken which are either carried out by or verified by independent agencies.

Figure 44 : SLB for NMT facilities (MoUD, 2012)
Table 41: Indicator for NMT facilities (MoUD, 2012)

Indicator	Description	Comments
NMT Coverage (% network covered)	The width of pedestrian path and cycle track can be combined if the roads are too narrow.	The area covered are arterials and sub arterials where the width of the roads are wide. The percentage of common cycle track and footpath should less than the segregated facility.
Encroachment on NMT roads by Vehicle parking (%)	Target should be to have not more than 30% of NMV roads encroached i.e. LoS of 3 within 1 year	Encroachment of vehicle parking affects the usability of the entire NMT infrastructure. Therefore, discounting some amount as acceptable is not in the interest of NMV users
NMT parking facilities at Interchanges (%)	Create NMT parking near all major bus stops, terminals and railway stations within a year.	

Similar exercise has been done in Public Transport Accessibility Toolkit ((MoUD), 2012) however performance assessment and benchmarking is still to be studied further.

Whilst there is a need to evaluate and assess various benchmarks suitable for the Indian context, something similar like star ratings can be used. Similar to the iRAP - Star Ratings, one can see the performance of city wide network over time. The focus of Star Ratings is on attributes that influence the most common and severe types of crashes for vehicle occupants, motorcyclists, pedestrians and bicyclists. (IRAP, 2009) iRAP Star Ratings are based on road inspection data and provide a simple and objective measure of the level of safety which is ‘built-in’ to the road for car occupants, motorcyclists, bicyclists and pedestrians. Five star roads are the safest while one-star roads are the least safe. Star Ratings provide a simple and objective measure of the level of safety provided by a road’s design. A similar methodology can be adopted for bicycle friendly infrastructure in India.

4.5.3 Auditing Tool – CyLOS

CyLOS which stands for Cycling Level of Service is a web based cycling infrastructure audit tool. (www.cylos.in) The tool uses inputs on planning and design details and compares it to the planning and design recommendations included in this guideline. The performance of input infrastructure is evaluated based on this comparison, and the same is scored using benchmarks and weightages listed.

Category	Category Weight				Indicators	Description	Category Specific Indicator Weight				Overall Indicator Weight%						
	Highway, Arterial or Sub arterial	Collector/ Distributory	Access	Standalone/ Independent			Highway, Arterial or Sub arterial	Collector/ Distributory	Access	Standalone/ Independent	Highway, Arterial or Sub arterial	Collector/ Distributory	Access	Standalone/ Independent			
Coherence	20%	20%	25%	25%	Infrastructure Relevance	How relevant is planned/constructed infrastructure to its context	35%	45%	65%	50%	7.00%	9.00%	16.25%	12.50%			
					Frequency of cycle crossings	How frequent are available opportunities for cyclists to cross the road	35%	25%	5%	5%	7.00%	5.00%	1.25%	1.25%			
					Cycle Specific Marking	Availability of adequate pavement marking to guide, warn and regulate cyclists	10%	10%	10%	20%	2.00%	2.00%	2.50%	5.00%			
					Cycle Specific signage	Availability of adequate sign boards to guide, warn and regulate cyclists	10%	10%	10%	20%	2.00%	2.00%	2.50%	5.00%			
					Cycle Box at Intersection	Availability of cycle box marking at intersection to hold crossing cyclists	10%	10%	10%	5%	2.00%	2.00%	2.50%	1.25%			
					Total					100%	100%	100%	100%				

Figure 45: Weightages for design principle - Coherence

Category	Category Weight				Indicators	Description	Category Specific Indicator Weight				Overall Indicator Weight%						
	Highway, Arterial or Sub arterial	Collector/ Distributory	Access	Standalone/ Independent			Highway, Arterial or Sub arterial	Collector/ Distributory	Access	Standalone/ Independent	Highway, Arterial or Sub arterial	Collector/ Distributory	Access	Standalone/ Independent			
Safety	30%	30%	30%	15%	Cycle Box at Intersection	Availability of cycle box marking at intersection to hold crossing cyclists	5%	5%	5%	5%	1.50%	1.50%	1.50%	0.75%			
					Crossing Safety Index	What is the level of safety in terms of crash risk and severity, at cyclist crossing facilities	20%	20%	5%	5%	6.00%	6.00%	1.50%	0.75%			
					Lighting quality index	What is the quality of lighting in terms of level and uniformity	15%	10%	20%	20%	4.50%	3.00%	6.00%	3.00%			
					Mid block accident safety	Assessment of accident risk for cyclist along the carriageway	25%	20%	15%	5%	7.50%	6.00%	4.50%	0.75%			
					Eyes on street	Assesment of level of activity along segment, to ensure security	20%	20%	25%	50%	6.00%	6.00%	7.50%	7.50%			
					Enforcement	Assessment of level of enforcement to ensure safety on carriageway.	5%	10%	5%	10%	1.50%	3.00%	1.50%	1.50%			
					Parking Friction Index	Assessment of risk posed by street parking to commuting cyclists	10%	15%	25%	5%	3.00%	4.50%	7.50%	0.75%			
					Total					100%	100%	100%	100%				

Figure 46: Weightages for design principle – Safety

Category	Category Weight				Indicators	Description	Category Specific Indicator Weight				Overall Indicator Weight%			
	Highway/Arterial or Sub arterial	Collector/Distributory	Access	Standalone/Independent			Highway/Arterial or Sub arterial	Collector/Distributory	Access	Standalone/Independent	Highway/Arterial or Sub arterial	Collector/Distributory	Access	Standalone/Independent
Safety	30%	30%	25%	25%	Enforcement	Assessment of level of enforcement to ensure minimal loss of directness to cyclists.	5%	10%	5%	5%	1.50%	3.00%	1.25%	1.25%
					Parking Friction Index	Assessment of loss of directness from friction by street parking to commuting cyclists	8%	25%	20%	5%	2.40%	7.50%	5.00%	1.25%
					Obstruction Index	Assessment of loss of directness caused by presence of obstruction in cycling path	21%	20%	20%	20%	6.30%	6.00%	5.00%	5.00%
					Width Sufficiency Index	Assessment of sufficiency of cycling path width with respect to vehicle size and cycle volume	21%	15%	5%	25%	6.30%	4.50%	1.25%	6.25%
					Hawker Friction Index	Assessment of loss of directness due to friction from hawkers on cycling path	10%	5%	8%	8%	3.00%	1.50%	2.00%	2.00%
					Frequency of punctures	How often is cycling lane/path crossed by vehicular path to access service lane/property entrance, etc.	8%	5%	2%	2%	2.40%	1.50%	0.50%	0.50%
					Pedestrian Friction Index	Assessment of loss of directness due to friction from pedestrians on cycle path	15%	10%	20%	15%	4.50%	3.00%	5.00%	3.75%
					Cyclist Delay at Intersection	Assessment of loss of directness due to delay to cyclists at intersections	4%	4%	6%	6%	1.20%	1.20%	1.50%	1.50%
					Maintenance	Assessment of loss of directness due to friction cause by poor maintenance/ cleaning cycle infrastructure	4%	4%	10%	10%	1.20%	1.20%	2.50%	2.50%
					Turning Radius	Assessment of loss of directness due to tight turning radiuses on cycling path	4%	2%	4%	4%	1.20%	0.60%	1.00%	1.00%
Total							100%	100%	100%	100%				

Figure 47 : Weightages for design principle – Directness

Category	Category Weight				Indicators	Description	Category Specific Indicator Weight				Overall Indicator Weight%			
	Highway/Arterial or Sub arterial	Collector/Distributory	Access	Standalone/Independent			Highway/Arterial or Sub arterial	Collector/Distributory	Access	Standalone/Independent	Highway/Arterial or Sub arterial	Collector/Distributory	Access	Standalone/Independent
Safety	15%	15%	15%	20%	Turning Radius	Assessment of loss of comfort due to tight turning radii on cycling path	8%	5%	5%	15%	1.20%	0.75%	0.75%	3.00%
					Riding Comfort Index	Assesment of riding comfort with reference to surface type	35%	35%	35%	35%	5.25%	5.25%	5.25%	7.00%
					Shaded Length	Assessment of protection from weather in terms of shade/shelter over cycling path	20%	20%	25%	25%	3.00%	3.00%	3.75%	5.00%
					Cross Slope Index	Assessment of water runoff capability and comfortable riding cross slope	7%	5%	3%	3%	1.05%	0.75%	0.45%	0.60%
					Longitudenal Slope Index	Assessment of comfortable riding longitudinal slope	20%	25%	25%	15%	3.00%	3.75%	3.75%	3.00%
					Ramp Slope Index	Assessment of comfort of ramps provide to access egress from cycle path.	5%	5%	2%	2%	0.75%	0.75%	0.30%	0.40%
					Parking Availability Index	Attractiveness of cycling infrastructure alongside landscaping/ plantation	5%	5%	5%	5%	0.75%	0.75%	0.75%	1.00%
					Total							100%	100%	100%

Figure 48: Weightages for design principle – Comfort

Category	Category Weight				Indicators	Description	Category Specific Indicator Weight				Overall Indicator Weight%			
	Highway/Arterial or Sub arterial	Collector/Distributory	Access	Standalone/Independent			Highway/Arterial or Sub arterial	Collector/Distributory	Access	Standalone/Independent	Highway/Arterial or Sub arterial	Collector/Distributory	Access	Standalone/Independent
Attractiveness	5%	5%	5%	15%	Parking Availability Index	Assesment of cycling comfort in terms of availability of safe and secure cycle parking	25%	20%	10%	5%	1.25%	1.00%	0.50%	0.75%
					Eyes on Street	Attraction of cycling infrastructure in terms of life/ activity along cycling path	20%	20%	25%	40%	1.00%	1.00%	1.25%	6.00%
					Maintenance	Attractiveness of cycling infrastructure in terms of how well it is maintained	40%	40%	40%	30%	2.00%	2.00%	2.00%	4.50%
					Landscaping	Attractiveness of cycling infrastructure in terms of along side landscaping/ plantation	15%	20%	25%	25%	0.75%	1.00%	1.25%	3.75%
Total							100%	100%	100%	100%	100%	100%	100%	100%

Figure 49: Weightages for design principle - Attractiveness

4.6 Annexure

4.6.1 Measures for Vulnerable Road Users (VRUs) - SP:55, 2013

Where pedestrians, including people with disabilities or visual impairment, have to move around a work site or to cross the road within a work site, they shall be provided with and directed to suitably constructed and protected temporary footpaths and crossing points, or formal pedestrian crossings, and also refuges, wherever provided. Such facilities should meet the requirements described. Pedestrian and bicycle paths should be of the same width and have the same facilities that existed prior to the work.

Guidance - In proposing measures for devices for pedestrians, people of disabilities and for cyclist in an area of road works, the following guidelines should be followed:

- It should be ensured that there is no danger to pedestrians from falling objects or sharp edges; these road users should not fall over or bump into anything.
- Scaffoldings should be marked with white bands at eye level and allow at least 2.1 m head room. It should be ensured that the barriers can be detected easily by a visually impaired person using a cane stick.
- Kerb ramps or raised footpaths should be provided to help blind, poorly sighted, elderly and disabled people and for those with prams or wheelchairs.
- Traffic calming devices like raised transverse bar markings and speed humps should be used near pedestrian crossings, where traffic speed is likely to be high, to ensure pedestrian safety.
- If excavations are deeper than 1.2 m, stronger Type III barricades will be required.
- The safety buffer is provided in the carriageway, if the works are closer to the kerb than the width of the lateral safety buffer clearance.
- If the works are on or near formally marked pedestrian crossings, care must be taken to avoid confusion to pedestrians.
- Clear guidance must be given as to where they are expected to cross while the works are ongoing.

Barriers for Pedestrians & Cyclists - Pedestrian barrier should be used to mark out any temporary footpath. A rigid barrier must always be used to protect pedestrians from traffic, excavations, plant or materials.

- Place warning lights at the end of the barriers at night. Portable pedestrian barriers, which may include mesh, should be reasonably rigid and have:
 - a hand rail fixed at between 1.0 m and 1.2 m above ground level, which should be reasonably smooth and rigid for pedestrians to hold to obtain guidance and some measure of support;
 - a visibility panel at least 150 mm deep which may be integral with the hand rail or if separate must be fixed, so that its upper edge is a minimum of 0.9 m above ground level. Visibility panels of yellow, white or orange colours are best for detection by partially sighted people, while the red and white rail gives a good contrast and provides interchangeability with traffic barriers ; and
 - a tapping rail (for blind people with a white stick) of min depth 150 mm with a lower edge at ground level or up to a maximum height of 200 mm above the ground.

When covers are required to be removed from underground chambers or manholes, a flag man should always be there, and also a barrier with a handrail fixed no lower than 0.8m above ground level will be satisfactory. In this case, the barrier must be large enough to enclose the opening. Pedestrian barrier can be used to block and to redirect the pedestrian movement, and plastic mesh barrier can segregate the pedestrians and construction activity area as given in Figure 6.2.

Plastic barricade should be at least 1m tall, be stable and not easily blown over, or displaced by moving traffic or pedestrians. It is sometimes a proprietary-made product of plastic post/frame with mounting devices with reflective discs or lamps. The material of the barricade and the ballast added to the base to provide stability should not become a potential hazard if struck. The portability of these devices is of particular advantage in emergencies that involve their regular displacement. It should be erected without gaps along pedestrian paths

throughout the work zone for the control of pedestrian movement to prevent injury or interference with the construction work activity. They may be erected at spacings not exceeding 20m along existing or new roads to inhibit access, if road is closed to traffic use. Plastic barricades should not be used next to deep excavations or steep falls where heavy pedestrian movement is expected. They should be placed such that a minimum distance of 0.5m separates the plastic barricade and the excavated pit. Water-filled barricades shall be used if heavy pedestrian movement is expected.

Works on Footpath: Alternative Way for Pedestrians - An alternative safe route for pedestrians must be provided if it is necessary to close a footpath or part of a footpath. Additional equipment may be required to do this. Pedestrian access to property must always be ensured. Temporary pedestrian ways should never be less than 1 m wide and, wherever possible, they should be 1.5 m or more in width. It must be ensured that pedestrians are not diverted onto an unguarded carriageway. If the temporary footpath is in the carriageway, the approach should be properly guarded and provided with signs. The lateral safety buffer clearance(s) must be on the traffic side of the pedestrian barriers.

In exceptional cases, the use of the other footpath may be acceptable on some quiet roads, but if this option is selected, the alternative route must be safe to use, and the needs of children and of people with disabilities must be taken into account.

Speed Reduction Measures - Most desirable speed reduction should be by enforcement system using radar speed guns on those who violate posted speed at the work zone. However, in addition to such arrangements, speed reduction devices may also be required for speed reduction at all times.

The speed reduction measures can be applied to approach to worksites where the pedestrians and cyclists exist in large numbers. Road humps can be of various chord lengths which will permit different passing speeds over the speed breaker (hump). The designs are available where chord lengths vary from 3m to 9.5m and vehicles can ply at 50kmph over a road hump of 9.5m chord length. In all cases the height should be 100mm only, and care shall be exercised to ensure that the height does not exceeds 100mm.

The raised bar marking using thermo-plastic paint or mastic sheets also can be installed across the carriageway. Generally two applications of thermoplastic to obtain 10-15mm height (300mm wide strips) can be provided at 600 to 1000 mm gaps (in 5 or 6nos in one place together). Three such sets can be provided respectively at 30m, 80m, 180m from the start of the construction zone for deliberate reduction of speed.

4.6.2 City Level Survey Formats

This requires assessing the existing transport infrastructure, traffic situation and level of service in terms of safety, security and comfort for different modes of transport. The layouts are prepared taking guidance from the ADB toolkit and the additional data to be collected is added to the same.

a. Inventory for pedestrian facility- survey from 1-2G in ADB toolkit

Along Road											
Name of road	Segregation tools to separate footpath from MV lane	Width of footpath (m)		From	To	Length (km)	Encroachment/ other barriers	Pavement condition	Lighting		Barrier free design
		L	R						Left	Right	
	kerbs/ green belt/ fences/ etc.						Parking/ vendors/trees/ light poles/ other services	Good/ Average/ Bad	y/n	y/n	Access at entry/ guiding tiles/ audible/none
At Intersection											
Name of intersection	Type of intersection	Type of crossing	Signalized	Pedestrian accentuated signal	Traffic calming tools	Crossing distance (meters)	Barrier free access				
	At grade/ flyover/ clover leaf/ roundabout/ others	Level/ raised/ foot over bridge/ subway	y/n	y/n	Rumble strips/ speed breakers		guiding tiles/ audible pedestrian crossing / none				

b. Inventory for NMV (bicycles and cycle rickshaws) facilities - survey from 1-2I in ADB toolkit

Along Road										
Name of road	Segregation tools to separate NMV lane from other modes	Width of NMV lane (m)		From	To	Length (km)	Encroachment	Pavement condition	Lighting	
		L	R						L	R
	Painted marking/ kerbed/ none						Parking/ vendors	Good/ Average/ Bad	y/n	y/n
At Intersection										
Name of intersection	Type of intersection	Type of crossing	Signalized	NMV accentuated signal	Traffic calming tools	Crossing distance	Other facilities			
	At grade/ flyover/ clover leaf/ roundabout, etc	Level/ raised/ grade separated	y/n	y/n	Rumble strips/ speed breakers		NMV box etc.			
Parking Area										
Name of Parking lot	Location	Nearest Pt stop	Distance to PT stop	Number of Parking	Parking charges					
					Bicycle	Cycle Rickshaw				

4.6.3 City Wide Cycle Infrastructure Assessment

The data source for the information to be filled in the form shall come from Comprehensive Mobility Plan (CMPs), CTTS, House Hold Surveys, Census Data, CPCB data and various designed status preference surveys. The data source for each indicator is mentioned in Annexure 4.6.64.6.5.

CITY LEVEL ASSESSMENT		
What is the modal share of the city? (in %)		SPECIFY CITY DETAILS Name of the city : State :
mode	Walk	
	Cycle	
	2W	
	Car	
	PT	
	iPT	
How much of the city is covered with roads		
	%	
% of Arterial / Sub-Arterial > 24m ROW in the city		
% of Collector > 15m ROW in the city		
% of Local Roads upto 15m ROW in the city		
% of trips (Trip length distribution)	%	
<=1 km		
>1km & <=5km		
>5km & <=10km		
>=10 km		
what is the average trip length for cyclists?	%	
<=1 km		
>1km & <=5km		
>5km & <=10km		
>=10 km		

Indicators	(A)	Quality (B)			(C)	Remark
	Present/ Yes (1 pt)	Good	Fair	Poor	(A x B)	
	Absent/ No (0 pt)	(1 pt)	(0.5 pt)	(0.2 pt)		
How many bicycle fatalities per 1 million population		<10 fatal	>10 - <20 fatal	>20 fatal		
% of risk exposure		0.0001	0.0002	0.0004		
How many roads have the following lux level						
Arterial / Sub-Arterial > 40 lux avg		>80%	50% - 80%	<50%		
Collector > 22 lux avg		>80%	50% - 80%	<50%		
Local Roads > 22 lux avg		>80%	50% - 80%	<50%		
% of cycle track on arterial		>75%	50% - 75%	<50%		
% of cycle lane + traffic calming on collector		>75%	50% - 75%	<50%		
% of traffic calming on local		>75%	50% - 75%	<50%		
How many people per 100,000 population feel safe from accidents while cycling on the following types of road						

Arterial / Sub-Arterial		>75%	50% - 75%	<50%		
Collector		>75%	50% - 75%	<50%		
Local		>75%	50% - 75%	<50%		
How many people per 100,000 population feel safe to cycle on the following type of roads						
% of people who feel safe to use cycle on an Arterial / Sub-Arterial road		>75%	50% - 75%	<50%		
% of people who feel safe to use cycle on a Collector road		>75%	50% - 75%	<50%		
% of people who feel safe to use cycle on a Local road		>75%	50% - 75%	<50%		
Maximum posted speed limit within the city area?						
% of roads having maximum posted speed limit for Highway passing through city 50km/h		100%	>75%	>60%		
% of roads having maximum posted speed limit for Arterial / Sub-Arterial (upto 50km/hr)		100%	>75%	>60%		
% of roads having maximum posted speed limit for Collector (upto 30km/hr)		100%	>75%	>60%		
% of roads having maximum posted speed limit for Local Roads (upto 15km/hr)		100%	>75%	>60%		
% of people in each income category who cycle to work						
<= 15000 rupees per month		>75%	50% - 75%	<50%		
> 15000 rupees per month - <=30000 Rs. pm		>75%	50% - 75%	<50%		
>30000 Rs. Per month		>75%	50% - 75%	<50%		
how much % of land has been allocated for NMT facilities in the city?		> last year city budget	= last year city budget	< Last year city budget		
what is the ambient air quality (Local Pollutants like PM2.5, PM10, SOx, NOx)						
NOx		Within acceptable	almost limit	exceeding limit		
SOx		Within acceptable	almost limit	exceeding limit		
PM2.5		Within acceptable	almost limit	exceeding limit		
PM10		Within acceptable	almost limit	exceeding limit		
what is the noise level in the city?						
db(A)		Within acceptable	almost limit	exceeding limit		
How much investment has been allocated to NMT facilities?		> last year city budget	= last year city budget	< Last year city budget		
Bicycle Parking availability at transit stations? (major & minor transportation areas)		70% - 100%	50%-70%	<50%		
% of Households in the city within 2km of cycling to PT stops		>75%	50% - 75%	<50%		

4.6.4 Cycle Audit Sheet at Corridor

4.6.4.1 Audit Checklist for Cyclist- Cycle Infrastructure Assessment at Corridor: Arterial / Sub Arterial Streets

The audit checklist is same as Checklist A -1.3 for Cyclist Infrastructure Provision on an Arterial/Sub-Arterial Street in the Urban Road Safety Toolkit (URSA) (MoUD, 2012). The audit methodology and the performance assessment remain same as given in the above mentioned toolkit.

CYCLE AUDIT FORM - ARTERIAL / SUB ARTERIAL STREETS

INSTRUCTIONS

- 1 In SEC A, tick mark or fill the form
- 2 In SEC B , for mid block fill points 1-25. For intersections fill points 1-30
- 3 For an arterial road and max speed limit 50 km/h, a segregated cycle track is compulsory on both sides
- 4 Audit needs to be conducted on both sides of the road.

A	Audit Area	Existing Infrastructure	<input type="checkbox"/>	Planned Infrastructure	<input type="checkbox"/>		
2	Road Type	Arterial/Sub Arterial	<input type="checkbox"/>	Collector	<input style="width: 80px;" type="text"/>	Local	<input type="checkbox"/>
3	Right Of Way (ROW)	<input style="width: 40px;" type="text"/>	m				
4	Length of Audit Area	<input style="width: 40px;" type="text"/>	m				
5	Posted Speed Limit	<input style="width: 40px;" type="text"/>	km/h				
6	Amenities (hawker spaces, etc)						
		Pedestrians provided some good amenities and feel safe					
		Limited number of provisions for pedestrians and slightly uncomfortable at late nights					
		No amenities and Unsafe					
7	SPEED MEASURES (Ref Checklist 1.1 URSA - (MoUD, 2012)	Maximum Speed Observed for Motorised modes	<input style="width: 150px; height: 30px;" type="text"/>			km/h	

Volume Measures	Cycle	Hand Drawn Rickshaws	Pedestrian
0-10min			
10-20min			
20-30 min			
30 - 40 min			
40 - 50 min			

50 - 60 min			
Average Volume			

B	Arterial / Sub Arterial	Present / Yes (1 pt)	Good	Fair	Poor	(AxB)
		Absent / No (0 pt)	(1 pt)	(0.5 pt)	(0.2 pt)	
1	Width of cycle track		>=2.5m - 5.0m	<2.5m - >=2.2m	< 1.8m	
2	Height of cycle track		+50mm - +100mm	0-50mm / '100-150mm	150 above or <0mm	
3	Location of cycle track		along the carriageway	Footpath separates cycle track from carriageway	Between property wall and service lane / combined with footpath/ any other location	
4	Distance from carriageway		>=0.75m upto <=1.2m	>0.3m upto <=0.75m / >1.2m - =3.0m	<=0.3m or >3.0m	
5	Type of segregation/ buffer zone		green belt / utility belt	green belt only	kerb only / any vertical surface higher than 180mm / railing	
6	Pavement surface		concrete/ asphalt	interlocking tiles / smooth tiles / stone	unpaved / non-metal surface	
7	Turning radius		Mostly Smooth (30m or more)	Partly Smooth (10m-30m)	Rough (0-10m)	
8	Barrier free (LHS/RHS)		No obstructions	Some obstructions	Mostly obstructed	
9	Slopes		Comfortable (Does not require extra effort to cycle)	Moderate (Require more extra effort to cycle)	Steep (Cannot be cycled)	
10	Lighting levels		Good lightning (tracks with avg. lighting level of 40lux)	Partial (tracks with avg. lighting level of 40 to 22lux)	Poor (tracks with avg. lighting level of <22lux)	
11	Traffic Calming at Minor Junctions (Speed breakers, raised crossing, rumble strips, etc.)		Present at all T- junctions	Present at most T- Junctions	Absent at most T-Junctions	
12	Cycle specific Marking		Frequent and Visible	Sometimes	Rarely or hardly visible	
13	Cycle specific Signage		Frequent and Visible	Sometimes	Rarely or hardly visible	
14	Shade		Complete	Mostly shaded	Lack of shade	

15	Land use along the footpath		Commercial (Retail) on both sides / Commercial (Retail) on one side and Residential or Commercial (Office) on the other side	Commercial (Retail) on one side and Vacant or Institutional land on the other / Both directions having Residential or Commercial (Offices)	Both sides vacant plot / Residential or Commercial Office on one side and Vacant/ institutional land on other	
16	Parking facility for cycles		Within 250m of the station / bicycle are allowed in the transit	Provided between 250 - 500 m of the station	Informal parking available within 500 m of the station	
17	Parking cost for cyclists		Free	Less than MV parking fee	Same as motor vehicle parking fees	
18	Effective width of footpath		With no obstructions	With some obstructions	Mostly obstructed	
19	Height of footpath		75mm above cycle track	50mm above cycle track	>75mm above cycle track	
20	Provision of footpath along segment		Along full length of the segment	More than 80% of the length of the segment	Less than 80% of the length of the segment	
21	Provision of service lane along segment		Along full length of the segment and not opening onto the intersection	More than 80% of the length of the segment	Less than 80% of the length of the segment	
22	Provision of on street parking along segment		None	Less than 80% of the length of the segment	More than 80% of the length of the segment	
23	Availability of at grade crossings		Avg. spacing between controlled crossings is < 500m	Avg. spacing between controlled crossings is between 500 m – 700 m	Avg. distance of controlled crossings is >700 m	
24	Type of additional crossings		Level/ at grade crossing	Foot over bridges with elevators or half subways which are well lit.	Foot over bridges without elevators or completely covered subways without proper lighting	
25	Time taken to cross road		Staged with refuge island	Staged without refuge island	High Waiting Time	
INTERSECTION						

26	Tapering of cycle track at intersections (reducing width for cyclists to increase turning radius for MV's and it is not good for cyclist)		No reduction in width at any intersection	Reduction in width at some intersections	Cycle track merged with turning vehicles at most intersections	
27	Markings showing the continuity of cycle tracks at intersection		Frequent and Visible	Sometimes	Rarely or hardly visible	
28	Ramps to get off / on at intersections		Frequent and Visible	Sometimes	Rarely or hardly visible	
29	Provision of lighting at crossing		Lit and enhanced visibility for motorised vehicles / Safe	Uncomfortable for crossing/ poorly lit	Unsafe and poorly lit	
30	Cycle track termination upto stop line (any other should be considered absent)		cycle track terminates at stop line leading to cycle box marking			

4.6.4.2 Audit Checklist for Cyclist- Cycle Infrastructure Assessment at Corridor: Collector Streets

The audit checklist is same as Checklist B -1.3 for Cyclist Infrastructure Provision on a Collector Street in the Urban Road Safety Toolkit (URSA) (MoUD, 2012). The audit methodology and the performance assessment remain same as given in the above mentioned toolkit.

CYCLE AUDIT FORM - COLLECTOR STREETS

INSTRUCTIONS

- In SEC A, tick mark or fill the form**
- In SEC B , for mid block fill points 1-23. For intersections fill points 1-26**
- For a collector road and max speed limit 30 km/h, a cycle lane is compulsory on both sides.**

A	Audit Area	Existing Infrastructure	<input type="checkbox"/>	Planned Infrastructure	<input type="checkbox"/>
2	Road Type	Arterial/Sub Arterial	<input type="checkbox"/>	Collector	<input type="checkbox"/>
		Local	<input type="checkbox"/>		<input type="checkbox"/>
3	Right Of Way (ROW)	<input type="checkbox"/> m			
4	Length of Audit Area	<input type="checkbox"/> m			
5	Posted Speed Limit	<input type="checkbox"/> km/h			

6 Amenities (hawker spaces, etc)

Pedestrians provided some good amenities and feel safe

Limited number of provisions for pedestrians and slightly uncomfortable at late nights

No amenities and Unsafe

7 **SPEED MEASURES** (Ref Checklist 1.1
URSA - (MoUD, 2012)

Maximum Speed Observed for Motorised modes

Volume Measures	Cycle	Hand Drawn Rickshaws	Pedestrian
0-10min			
10-20min			
20-30 min			
30 - 40 min			
40 - 50 min			
50 - 60 min			
Average Volume			

B	Collector Streets	Present / Yes (1 pt)	Good	Fair	Poor	(AxB)
		Absent / No (0 pt)	(1 pt)	(0.5 pt)	(0.2 pt)	
1	Width of lane		1.5m - 1.8m	1.5m - 1.2m	<1.2m	
2	Height of cycle lane (should be the same as carriageway. Any other level should be zero)		0.0m	NA	NA	
3	Location of cycle lane		Along MV lane (between Carriageway and Street Parking)	Along MV lane (Between Street Parking and Footpath)	Along median	
4	Distance from carriageway		0.0m	0.0 - 0.3m	0.3m - 1.5m	
5	Type of segregation/ buffer zone		Painted marking	Reflector studs	Kerb	
6	Pavement surface	Concrete/ asphalt (same as carriageway)	Interlocking tiles / smooth tiles / stone	Unpaved / non-metal surface		
7	Turning radius		follows road alignment and has smooth edges	NA	follows road alignment with kinky edges	

8	Obstructions on bicycle lane (LHS/RHS) (In this case friction from car parking will be considered as obstruction also)		No obstructions	Some obstructions	Mostly obstructed	
9	Lighting levels		Good lightning (tracks with avg. lighting level of 20lux)	Partial (tracks with avg. lighting level of 20 to 10lux)	Poor (tracks with avg. lighting level of <10lux)	
10	Traffic Calming at Minor Junctions (Speed breakers, raised crossing, rumble strips, etc.)		Present at all T- junctions	Present at most T- Junctions	Absent at most T-Junctions	
11	Cycle specific Marking		Continuous and Visible	Discontinuous & partly visible	Rarely or hardly visible	
12	Cycle specific Signage		Continuous and Visible	Discontinuous & partly visible	Rarely or hardly visible	
13	Shade		Complete	Mostly shaded	Lack of shade	
14	Land use along the footpath		Commercial (Retail) on both sides / Commercial (Retail) on one side and Residential or Commercial (Office) on the other side	Commercial (Retail) on one side and Vacant or Institutional land on the other / Both directions having Residential or Commercial (Offices)	Both sides vacant plot / Residential or Commercial Office on one side and Vacant/ institutional land on other	
15	Parking facility for cycles		Within 250m of the station / bicycles are allowed in the transit	Provided between 250 - 500 m of the station	Informal parking available within 500 m of the station	
16	Parking cost for cyclists		Free	Less than MV parking fee	Same as motor vehicle parking fees	
17	Effective width of footpath		With no obstructions	With some obstructions	Mostly obstructed	
18	Height of footpath		75mm above cycle track	50mm above cycle track	>75mm above cycle track	
19	Provision of footpath along segment		Along full length of the segment	More than 80% of the length of the segment	Less than 80% of the length of the segment	
20	Provision of on street parking along segment		Provided and no friction to cyclists	Provided but less friction to cyclists	Provided but high friction to cyclists	
21	Availability of at grade crossings		Avg. spacing between controlled crossings is < 500m	Avg. spacing between controlled crossings is between 500 m – 700 m	Avg. distance of controlled crossings is >700 m	

22	Type of additional crossings		Level/ at grade crossing	Foot over bridges with elevators or half subways which are well lit.	Foot over bridges without elevators or completely covered subways without proper lighting	
23	Time taken to cross road		In one pedestrian green phase	Staged without refuge island	High Waiting Time	
INTERSECTION						
24	Blocking of cycle lane by turning vehicles at junction		NA	NA	Lane occupied by turning vehicles	
25	Markings showing the continuity of cycle lane upto intersection		Frequent and visible	Sometimes	Rarely or hardly visible	
26	Provision of lighting at crossing		Lit and enhanced visibility for motorised vehicles / Safe	Uncomfortable for crossing/ poorly lit	Unsafe and poorly lit	

4.6.4.3 Audit Checklist for Cyclist- Cycle Infrastructure Assessment at Corridor: Local Streets

The audit checklist is same as Checklist C-2 for Cyclist Infrastructure Provision on a Collector Street in the Urban Road Safety Toolkit (URSA) (MoUD, 2012). The audit methodology and the performance assessment remain the same as that given in the above mentioned toolkit.

CYCLE AUDIT FORM - LOCAL STREETS

INSTRUCTIONS

- 1 In SEC A, tick mark or fill the form
- 2 In SEC B , for mid block fill points 1-11. For intersections fill points 1-13
- 3 For a local road and max speed limit 15 km/h, the facility for cyclists is shared with other modes of transport

A	Audit Area	Existing Infrastructure	<input type="checkbox"/>	Planned Infrastructure	<input type="checkbox"/>
2	Road Type	Arterial/Sub Arterial	<input type="checkbox"/>	Collector	<input type="checkbox"/>
		Local	<input type="checkbox"/>		<input type="checkbox"/>
3	Right Of Way (ROW)	<input type="checkbox"/> m			
4	Length of Audit Area	<input type="checkbox"/> m			
5	Posted Speed Limit	<input type="checkbox"/> km/h			
SPEED MEASURES					
6	Ref Checklist 1.1 URSA - (MoUD, 2012)	Maximum Speed Motorised modes	Observed for	<input type="checkbox"/>	km/h

Volume Measures	Cycle	Hand Drawn Rickshaws	Pedestrian
0-10min			
10-20min			
20-30 min			
30 - 40 min			
40 - 50 min			
50 - 60 min			
Average Volume			

B	Access Streets	Present / Yes (1 pt)	Good	Fair	Poor	(AxB)
		Absent / No (0 pt)	(1 pt)	(0.5 pt)	(0.2 pt)	
1	Pavement surface		concrete/ asphalt (same as carriageway)	interlocking tiles / smooth tiles / stone	unpaved / non-metal surface	
2	Turning radius		follows road alignment and has smooth edges	NA	follows road alignment with kinky edges	
3	Obstructions for cyclists (LHS/RHS) (In this case friction from car parking will be considered as obstruction also)		No obstructions	Some obstructions	Mostly obstructed	
4	Lighting levels		Good lightning (tracks with avg. lighting level of 20lux)	Partial (tracks with avg. lighting level of 20 to 10lux)	Poor (tracks with avg. lighting level of <10lux)	
5	Traffic Calming at Minor Junctions (Speed breakers, raised crossing, rumble strips, etc.)		Present at all T- junctions	Present at most T- Junctions	Absent at most T-Junctions	
6	Cycle specific Signage		Continuous and Visible	Discontinuous & partly visible	Rarely or hardly visible	
7	Land use along the footpath		Commercial (Retail) on both sides / Commercial (Retail) on one side and Residential or Commercial (Office) on the other side	Commercial (Retail) on one side and Vacant or Institutional land on the other / Both directions having Residential or Commercial (Offices)	Both sides vacant plot / Residential or Commercial Office on one side and Vacant/ institutional land on other	
8	Parking facility for cycles		Within 250m of the station / bicycle are allowed in the transit	Provided between 250 - 500 m of the station	Informal parking available within 500 m of the station	

9	Parking cost for cyclists		Free	Less than MV parking fee	Same as motor vehicle parking fees	
10	Effective width of footpath (if segregated)		With no obstructions	with some obstructions	mostly obstructed	
11	Provision of on-street parking along segment		Provided and no friction to cyclists	Provided but less friction to cyclists	Provided but high friction to cyclists	
12	Availability of at grade crossings		Avg. spacing between controlled crossings is < 500m	Avg. spacing between controlled crossings is between 500 m – 700 m	Avg. distance of controlled crossings is >700 m	
13	Type of additional crossings		Level/ at grade crossing	Foot over bridges with elevators or half subways which are well lit.	Foot over bridges without elevators or completely covered subways without proper lighting	

4.6.5 Cycle Accessibility at Transit Facility

4.6.5.1 Audit Checklist for Cyclist Accessibility at Transit Facility on a Arterial/ Sub Arterial Road.

The audit checklist is same as Checklist 8.2 & Checklist 10.2 for Cyclist Accessibility on a Arterial/Sub-Arterial Street in the Public Transportation Accessibility Toolkit. ((MoUD), 2012). The audit methodology and the performance assessment remain the same as that given in the above mentioned toolkit.

CYCLE AUDIT FORM FOR TRANSIT FACILITY AT ARTERIAL / SUB ARTERIAL STREETS

INSTRUCTIONS

- 1 In SEC A, tick mark or fill the form
- 2 In SEC B , for mid block fill points 1-28 and at intersection fill 1-30

A	Audit Area	Existing Transit Facility <input type="checkbox"/>	Proposed Transit Facility <input type="checkbox"/>
2	Transit Type	Metro/Monrail / Closed BRT	Regular City Bus / Open BRT <input style="width: 50px; height: 20px;" type="text"/>
3	Right Of Way (ROW)	<input style="width: 30px; height: 20px;" type="text"/> m	
4	Posted Speed Limit	<input style="width: 30px; height: 20px;" type="text"/> km/h	
5	Amenities (hawker spaces, etc)		

Pedestrians provided some good amenities and feel safe

Limited number of provisions for pedestrians and slightly uncomfortable at late nights

No amenities and Unsafe

6 **SPEED MEASURES (Ref Checklist 8)** Maximum Speed Observed for Motorised modes km/h

Volume Measures	Cycle	Hand Drawn Rickshaws	Pedestrian
0-10min			
10-20min			
20-30 min			
30 - 40 min			
40 - 50 min			
50 - 60 min			
Average Volume			

B	Arterial / Sub Arterial	Present / Yes (1 pt) Absent / No (0 pt)	Good (1 pt)	Fair (0.5 pt)	Poor (0.2 pt)	(AxB)
1	Width of cycle track		>=2.5m - 5.0m	<2.5m - >=2.2m	< 1.8m	
2	Height of cycle track		+50mm - +100mm	0-50mm / '100-150mm	150 above or <0mm	
3	Location of cycle track		Along the carriageway	Footpath separates cycle track from carriageway	Between property wall and service lane / combined with footpath/ any other location	
4	Distance from carriageway		>=0.75m upto <=1.2m	>0.3m upto <=0.75m / >1.2m - =3.0m	<=0.3m or >3.0m	
5	Type of segregation/ buffer zone		Green belt / utility belt	Green belt only	Kerb only / any vertical surface higher than 180mm / railing	
6	Pavement surface		Concrete/ asphalt	Interlocking tiles / smooth tiles / stone	Unpaved / non-metal surface	
7	Turning radius		Mostly Smooth (30m or more)	Partly Smooth (10m-30m)	Rough (0-10m)	

8	Barrier free (LHS/RHS)		No obstructions	Some obstructions	Mostly obstructed	
9	Slopes		Comfortable (Does not require extra effort to cycle)	Moderate (Require extra effort to cycle)	Steep (Cannot be cycled)	
10	Lighting levels		Good lightning (tracks with avg. lighting level of 40lux)	Partial (tracks with avg. lighting level of 40 to 22lux)	Poor (tracks with avg. lighting level of <22lux)	
11	Traffic Calming at Minor Junctions (Speed breakers, raised crossing, rumble strips, etc.)		Present at all T- junctions	Present at most T- Junctions	Absent at most T-Junctions	
12	Cycle specific Marking		Frequent and visible	Sometimes	Rarely or hardly visible	
13	Cycle specific Signage		Frequent and visible	Sometimes	Rarely or hardly visible	
14	Shade		Complete	Mostly shaded	Lack of shade	
15	Land use along the footpath		Commercial (Retail) on both sides / Commercial (Retail) on one side and Residential or Commercial (Office) on the other side	Commercial (Retail) on one side and Vacant or Institutional land on the other / Both directions having Residential or Commercial (Offices)	Both sides vacant plot / Residential or Commercial Office on one side and Vacant/ institutional land on other	
16	Parking facility for cycles		Within 250m of the station / bicycle are allowed in the transit	Provided between 250 - 500 m of the station	Informal parking available within 500 m of the station	
17	Parking cost for cyclists		Free	Less than MV parking fee	Same as motor vehicle parking fees	
18	Effective width of footpath		with No obstructions	with some obstructions	mostly obstructed	
19	Height of footpath		75mm above cycle track	50mm above cycle track	>75mm above cycle track	
20	Provision of footpath along segment		Along full length of the segment	More than 80% of the length of the segment	Less than 80% of the length of the segment	
21	Provision of service lane along segment		Along full length of the segment and not opening onto the intersection	More than 80% of the length of the segment	Less than 80% of the length of the segment	
22	Provision of on street parking along segment		None	Less than 80% of the length of the segment	More than 80% of the length of the segment	

23	Availability of at grade crossings		Avg. spacing between controlled crossings is < 500m	Avg. spacing between controlled crossings is between 500 m – 700 m	Avg. distance of controlled crossings is >700 m	
24	Type of additional crossings		Level/ at grade crossing	Foot over bridges with elevators or half subways which are well lit.	Foot over bridges without elevators or completely covered subways without proper lighting	
25	Time taken to cross road		Staged with refuge island	Staged without refuge island	High Waiting Time	
26	Provision of lighting at crossing		Lit and enhanced visibility for motorised vehicles / Safe	Uncomfortable for crossing/ poorly lit	Unsafe and poorly lit	
27	Parking facility for IPT		Within 250m of the station / bicycle are allowed in the transit	Provided between 250 - 500 m of the station	Informal parking available within 500 m of the station	
28	Parking facility for MV		Within 250m of the station / bicycle are allowed in the transit	Provided between 250 - 500 m of the station	Informal parking available within 500 m of the station	
29	Tapering of cycle track at intersections (reducing width for cyclists in order to increase turning radius for MV's)		No reduction in width at any intersection	Reduction in width at some intersections	Cycle track merged with turning vehicles at most intersections	
30	Ramps to get off / on at intersections		Frequent and visible	Sometimes	Rarely or hardly visible	

4.6.5.2 Cycle Infrastructure Accessibility at Transit Facility at Collector Roads

The audit checklist is same as Checklist 9.2 & Checklist 11.2 for Cyclist Accessibility on a Arterial/Sub-Arterial Street in the Public Transportation Accessibility Toolkit. ((MoUD), 2012). The audit methodology and the performance assessment remain same as given in the above mentioned toolkit.

CYCLE AUDIT FORM FOR TRANSIT FACILITY AT COLLECTOR STREETS

INSTRUCTIONS

- 1 In SEC A, tick mark or fill the form
- 2 In SEC B , for mid block fill points 1-26

A	Audit Area	Existing Transit Facility	<input type="checkbox"/>	Proposed Transit Facility	<input type="checkbox"/>
2	Transit Type	Metro/Monrail / Closed BRT	<input style="width: 50px; height: 20px;" type="text"/>	Regular City Bus / Open BRT	<input style="width: 50px; height: 20px;" type="text"/>
3	Right Of Way (ROW)		<input style="width: 20px; height: 20px;" type="text"/> m		
4	Posted Speed Limit		<input style="width: 20px; height: 20px;" type="text"/> km/h		
5	Amenities (hawker spaces, etc)				
	<input style="width: 150px; height: 25px;" type="text"/>	Pedestrians provided some good amenities and feel safe			
	<input style="width: 150px; height: 25px;" type="text"/>	Limited number of provisions for pedestrians and slightly uncomfortable at late nights			
	<input style="width: 150px; height: 25px;" type="text"/>	No amenities and Unsafe			
6	SPEED MEASURES (Ref Checklist 8)	Maximum Speed Observed for Motorised modes	<input style="width: 100px; height: 25px;" type="text"/>		km/h

Volume Measures	Cycle	Hand Drawn Rickshaws	Pedestrian
0-10min			
10-20min			
20-30 min			
30 - 40 min			
40 - 50 min			
50 - 60 min			
Average Volume			

B	Collector streets	Present / Yes (1 pt)	Good	Fair	Poor	(AxB)
		Absent / No (0 pt)	(1 pt)	(0.5 pt)	(0.2 pt)	
1	Width of lane		1.5m - 1.8m	1.5m - 1.2m	<1.2m	
2	Height of cycle lane (should be at the same level as carriageway/ any other level to be considered as absent)		0.0m	NA	NA	
3	Location of cycle lane		Along MV lane (between Carriageway and Street Parking)	Along MV lane (Between Street Parking and Footpath)	Along median	
4	Distance from carriageway		0.0m	0.0 - 0.3m	0.3m - 1.5m	
5	Type of segregation/ buffer zone		Painted marking	Reflector studs	Kerb	
6	Pavement surface		Concrete/ asphalt (same as carriageway)	Interlocking tiles / smooth tiles / stone	Unpaved / non-metal surface	
7	Turning radius		Follows road alignment and has smooth edges	Follows road alignment with kinky edges	NA	
8	Obstructions on bicycle lane (LHS/RHS) (In this case friction from car parking will be considered as obstruction)		No obstructions	Some obstructions	Mostly obstructed	
9	Lighting levels		Good lightning (tracks with avg. lighting level of 20lux)	Partial (tracks with avg. lighting level of 20 to 10lux)	Poor (tracks with avg. lighting level of <10lux)	
10	Traffic Calming at minor junctions (speed breakers, raised crossing, rumble strips, etc.)		Present at all T- junctions	Present at most T- Junctions	Absent at most T-Junctions	
11	Cycle specific marking		Continuous and Visible	Discontinuous & partly visible	Rarely or hardly visible	
12	Cycle specific signage		Continuous and Visible	Discontinuous & partly visible	Rarely or hardly visible	
13	Shade		Complete	Mostly shaded	Lack of shade	
14	Land use along the footpath		Commercial (Retail) on both sides / Commercial (Retail) on one side and Residential or Commercial (Office) on the other side	Commercial (Retail) on one side and Vacant or Institutional land on the other / Both directions having Residential or Commercial (Offices)	Both sides vacant plot / Residential or Commercial Office on one side and Vacant/ institutional land on other	

15	Parking facility for cycles		Within 250m of the station / bicycle are allowed in the transit	Provided between 250 - 500 m of the station	Informal parking available within 500 m of the station	
16	Parking cost for cyclists		Free	Less than MV parking fee	Same as motor vehicle parking fees	
17	Effective width of footpath		With no obstructions	With some obstructions	Mostly obstructed	
18	Height of footpath		75mm above cycle track	50mm above cycle track	>75mm above cycle track	
19	Provision of footpath along segment		Along full length of the segment	More than 80% of the length of the segment	Less than 80% of the length of the segment	
20	Provision of on street parking along segment		Provided and no friction to cyclists	Provided but less friction to cyclists	Provided but high friction to cyclists	
21	Availability of at grade crossings		Avg. spacing between controlled crossings is < 500m	Avg. spacing between controlled crossings is between 500 m – 700 m	Avg. distance of controlled crossings is >700 m	
22	Type of additional crossings		Level/ at grade crossing	Foot over bridges with elevators or half subways which are well lit.	Foot over bridges without elevators or completely covered subways without proper lighting	
23	Time taken to cross road		In one pedestrian green phase	Staged without refuge island	High waiting time	
24	Provision of lighting at crossing		Lit and enhanced visibility for motorised vehicles / Safe	Uncomfortable for crossing/ poorly lit	Unsafe and poorly lit	
25	Parking facility for IPT		Within 250m of the station / bicycle are allowed in the transit	Provided between 250 - 500 m of the station	Informal parking available within 500 m of the station	
26	Parking facility for MV		Within 250m of the station / bicycle are allowed in the transit	Provided between 250 - 500 m of the station	Informal parking available within 500 m of the station	

4.6.6 List of indicators for NMT derived from LCMP Toolkit (UNEP, 2012)

Indicator Name	Description	Measurement/ data source	Relevance
Mobility and accessibility			
Modal shares*	Cycling Mode shares by trip purpose i.e. work, education, health and others	Household surveys and some relevant data may also be available in City Traffic and Transport Study (CTTS) and Comprehensive Mobility Plan (CMP)	Average modal share helps decision makers understand the movement towards or away from the goal of low carbon transport. The indicator helps to identify the preferable modes for various trip purposes and thus the intervention areas. For example, improving infrastructure for students so that they can use Non-Motorized Transport (NMT).
	Cycling modal shares by social groups i.e. by income, women headed household	National Sample Survey Organization (NSSO) data and household surveys	The indicator states the equity in service levels. It helps to understand whether the low carbon transport is by choice for vulnerable groups of society.
Travel time*	Average travel time by trip purpose i.e. work, education, health and others using different modes	Household surveys or use validated four step model for different cities	The indicator is useful to understand the dynamics of land use and the properties of mode to reach specific destinations and accordingly plan strategies to achieve the low carbon goal. For example, less travel time to school using cycle will motivate students to use cycle to go to school and this can be done by taking up policies related to land use and infrastructure improvement.
	Trip purpose wise average travel time disaggregated by social groups	Four step model to capture travel time by specific social groups for different trip purpose	More travel time for vulnerable groups is an indicator of social exclusion and with the help of disaggregation by trip purpose, specific measures can be taken to increase social sustainability
Trip length*	Average trip length frequency distribution	CMP or CTTS for specific cities or four step model	The indicator states the potential of using NMT and Public transport (PT).
	Average cycling trip length disaggregated by social groups ⁴	Household survey	The indicator defines the social cohesiveness in city. Longer trip length using NMT by lower income group as compared to middle or high income group not only indicates social exclusiveness but also unaffordable public transport system for the group.
	Trip purpose wise average trip length disaggregated by social groups	Household survey or relevant data from NSSO	The indicator helps to identify the required change in land use structure specifically for the different groups of society to attain social sustainability

⁴Needs to measure all modes including pedestrians, bicycles, public transport (bus formal), public transport (tempos), para-transit (cycle rickshaw), para-transit (auto), motorized two wheeler and cars

*For these indicators the data should be collected separately for vulnerable groups such as: i) Slum dwellers ii) Within the slums, of households living in katcha housing as that is indicating BPL households iii) Recent migrants to the city and temporary migrants to the city iv) Households living in relocated sites v) SC households vi) Minority groups vii) street vendors etc. The data should also be disaggregated by sex

Land use parameters	Land use mix intensity	Job-housing balance determined using census data available at ward or electoral block level	Indicates land use pattern that has impact on the trip rate and trip length
	Income level heterogeneity	Concentration index of different income groups in a zone determined by asset ownership or housing type data in census-households	Indicates social cohesion
	Kernel density of roads, junctions and PT stop	Requires road inventory and public transport network data in vector form	Determines all over accessibility of city areas to transport infrastructure irrespective of the scale of study
Infrastructure quality, safety, ease and comfort of using particular mode			
Infrastructure quality	Percentage of household within 10 min cycling distance of PT and para-transit stop	Needs to be calculated based on the PT stop inventory and number of households in census records	It's a determinant of accessibility as well as pressure for low carbon transport. Short distance determines the ease of access to PT and hence high probability of using PT.
	Average number of interchanges per PT trip	Household surveys	Determines the efforts required to use public transport that effects competitiveness of PT with Private Motorised Vehicles
	Accessibility for disadvantaged by different modes	More specific indicators to be able to measure accessibility for disadvantaged people needs to be developed and data be collected	Ensures barrier free accessibility to the society by non-motorized transport and public transport system
	Bicycle Parking Availability	Needs to be calculated based on the NMV related questions in the road inventory survey	Ensures inter-modal integration with public transport and also safety for bicyclists at their destination locations.
	Risk exposure for cyclists	Number of fatal accident per 100,000 users of the mode. Detailed accident data can be collected from traffic police	The indicator is the state of social sustainability and also a pressure for environmental sustainability. More the risk to a mode user less is the preference.
Safety	Overall safety	Number of fatal accidents per 100,000 populations. Detailed accident data can be collected from traffic police.	Determine health impact of transportation on society
	Speed limit restrictions	Percentage of roads having speed limit ≥ 50 kmph	More speed means more risk.
	Percentage of well lit roads	Data needs to be collected as a part of Road inventory survey	Determines the security aspect on the road
	Percentage of footpaths lighted	Data needs to be collected as a part of road inventory survey	Determines the security aspect on the footpath there by encouraging people to walk
	Percentage of people feeling safe to cycle in city by gender*	Specially designed stated household surveys	Perception of people regarding safety aspect of using low carbon modes of transport may avoid them to use these modes since the access to the carbon intensive modes of transport is high.
Security	Percentage of households owning cycles disaggregated by income	Based on household interview data	Determines the affordability of cycling by different social / income groups.

	Cost of commuting	% of Household income invested for travelling disaggregated by social groups	Depends on the destinations, mode choice and the fare and pricing policies. Determines social equity.
		Disaggregated by social groups	Determines social equity
Environmental impacts			
Emissions	Land used for different transport activities	Percentage of total land used in transport for different type of transport infrastructure- road, parking bus lanes, railways, etc.	Determines the impact of different type of transport infrastructure on land depletion
	Percentage of population exposed to air pollution	Need to map air quality in city and mark households in the buffer area Or Get the relevant morbidity data from hospitals or medical authorities	Determine the health impact of transportation and identify the obnoxious gases or other such factors that need to be reduced from transport sector to improve health. Also the indicator is helpful in raising concern regarding sustainable transport.
Depletion of land resource	Percentage of population exposed to noise levels > 50 dB*	Need to map exceedance of noise levels in city and mark households in the buffer area	Determine the health impact of transportation and identify the obnoxious gases or other such factors that need to be reduced in the transport sector to improve health. Also the indicator is helpful in raising concern regarding sustainable transport.
	Percentage of population exposed to noise levels > 50 dB*	Need to map exceedance of noise levels in city and mark households in the buffer area	Determine the health impact of transportation and identify the obnoxious gases or other such factors that need to be reduced in the transport sector to improve health. Also the indicator is helpful in raising concern regarding sustainable transport. Determines investment pattern on different types of infrastructure and traces the trend in development of infrastructure for low carbon modes of transport
Health hazards	Trend in investments for development of infrastructure for cycling	Data from city budgets across years	Determine the health impact of transportation and identify the obnoxious gases or other such factors that need to be reduced in the transport sector to improve health. Also the indicator is helpful in raising concern regarding sustainable transport. Determines investment pattern on different types of infrastructure and trace the trend in development of infrastructure for low carbon modes of transport
Investment			Other charges have impact on the operational cost of the mode. For example, the high toll and parking charges on cars will discourage people from using it.

5 Glossary

Advance Transition Zone: This zone is to warn and prepare the road user for the change in driving conditions (due to construction activity) ahead.

Bicycle Box: Waiting space for cyclists at intersections. It is provided on the near side of the intersection ahead of the stop line.

Carriageway: Area allocated on cross section for the motorists to ply.

Captive Cyclists: They are bound by economic constraints and do not have an alternative choice of transport.

Cross Section: Space allocation for various road users according to road type

Cycle Lane: At grade facility for cyclists along the carriageway identified using road marking. It is provided on all collector streets where design speed is upto 30km/h

Cycle Track: A segregated infrastructure for cyclists identified by segregation in plan and height from the carriageway. It should run along the carriageway. It is compulsory for arterial and sub arterial roads and collector roads with high friction from on street parking.

Household Travel Survey: A survey designed to measure household travel behavior and the characteristics of the household that are relevant to its travel behavior. The survey typically collects information on the household, household members, household vehicles, and a travel activity diary that records all activity and travel that occurs during the survey period.

Mixed Traffic: Traffic lanes where motorised and non motorised modes move together.

Mode: A means of conveyance between origins and destinations, modes are motorized (cars and other private vehicles, buses, rail transit) and non-motorized (walking, bikes).

Mode Choice: Mode Choice (MC) is the third step in the conventional four step model of travel forecasting. MC is the process by which a traveler chooses a transportation mode for a trip, given the trip's purpose, origin, and destination (the results of the first two steps of the four step model); characteristics of the traveler; and characteristics of the modes available to the traveler. Mode choice typically follows trip distribution in the four step model sequence.

Non Motorised Transport: This includes walking, cycling and hand drawn cycle rickshaws to meet access needs.

Para Transit: Small three wheeled or four wheeled vehicles used as shared taxis or route taxis. They are called as Intermediate Public Transport

Potential Cyclists: Cyclists who cycle by choice

Primary Footpath: The sidewalk along the cycle track and closest to the carriageway.

Right of Way (ROW): It is the distance of the road between property edges on the either side of the road

Secondary Footpath: In wide roads where there is a possibility of a service lane, these sidewalks run along the edge of the right of way or next to property wall/ entrances.

Segment: Different section along a linear path, in this case a road.

Termination Zone: The culminating end is called the Termination Zone. To ensure smooth and conflict free movement of traffic, it is advisable to use Advance-Warning signs at the initial and culmination areas of transition zone

Transition Zone: Moving zone or Transition zone is generally not affected by construction activity and serves the function of physically reducing vehicular speeds to the construction zone through the use of adequate traffic control devices.

Traffic Analysis Zone: A defined zone for travel forecasting and traffic simulation studies, represented in the network by a centroid.

Traffic Calming Measures : Measures which are used as part of the road design to manage speeds of motorised vehicles.

Traffic Management Plan (TMP) : They provide for the reasonably safe and efficient movement of road users through or around the work zones while reasonably protecting the workers and equipment.

Travel Behavior : The travel and associated activities in which individuals engage over space and time

Travel Demand: The derived demand to access locations via the transportation system to perform activities.

Travel Demand Forecasting: The process of estimating, calibrating, validating, and applying models of travel demand and performance to estimate the impacts of alternative transportation systems.

Trip: A movement by an individual from one location to perform an activity at a different location. The fundamental unit of analysis in most travel forecasting models to date.

Trip Attraction: A trip generated (typically) by a household has both a production and an attraction. The number of trip attractions in a zone is proportional to the level of activity (land use) in that zone associated with the type of trip in question. If the trip maker's residence (home) is one end of the trip, then the other trip end is the attraction. If the trip maker's residence (home) is at neither trip end (i.e., a NHB trip), then the attraction is the same as the trip destination. Trip attractions are typically represented as aggregate regression models using data pooled from zones into districts (since travel surveys are residential-based, there are usually not enough observed attractions in all zones to estimate zonal attractions directly).

Trip Assignment: Trip Assignment (TA), the fourth step in the conventional four step model of travel forecasting, is a process by which trips, defined by time-of-day and mode, are loaded on feasible paths between an origin and a destination in a network. The output of assignment is the number of vehicle-trips (or passenger-trips) allocated to paths and links on a modal network, as well as associated performance measures (such as VMT and travel time). This is also known as traffic assignment or network assignment.

Trip Distribution: Trip Distribution (TD) is the second step in the conventional four step model of travel forecasting. TD is the process of pairing generated productions and attractions (or origins and destinations) to determine the number of trips between all pairs of zones in the study area. The primary TD output are trip tables (typically 24-hour person trips, specified by trip purpose). TD follows trip generation in the four step model sequence, and is followed by mode choice or time-of-day factoring. The gravity model is the most common tool applied. In disaggregate terms, it is the process by which a trip's destination is selected, given the trip's purpose, origin, and travel cost to possible destinations.

Trip Generation: Trip Generation (TG) is the first step in the conventional four step model of travel forecasting. TG is the process of estimating trip productions (or origins) and attractions (or destinations) for all zones in the study area. In regional travel forecasting studies, category or regression models are applied to estimate trip ends by trip purpose as a function of individual, household, or zonal socio-economic, land use, or accessibility characteristics (results are typically aggregated to the zone level). In traffic impact studies, land use-based trip rates are applied at the project or parcel level in place of regional TG models. The outputs of trip generation serve as input to the second step of the four step process, trip distribution.

Trip Length: Distance of one way trip from origin to destination, measured in kms.

Trip Purpose: The purpose of virtually any trip is the activity in which the trip maker will participate at the location of the end of the trip. The demand for the trip is derived from the demand for the activity. Conventional travel forecasting models often employ aggregate trip purposes in lieu of actual trip purposes. Such purposes usually identify both ends of the trip preceding the activity, such as home-work (or HBW), home-other (or HBO), or non-home-based (or NHB).

Trip Rate: For a specified land use or geographic area, a trip rate is the number of trips per unit time, typically scaled per a real or other unit. For example, the number of vehicle-trips entering a 7-11 store in a peak hour for every 1000 square feet of retail floor space. Trip rates may be expressed as mode-specific or by time of day. Trip rates, in general, are modelled in the four step model in trip generation via techniques such as category analysis (which yields a trip rate model).

Utility Belt: Area in the cross section where all services are located (both above ground and underground). In arterials, this belt (varying from 0.75m – 1.5m in width) can be used to segregate cycle track from carriageway.

Vulnerable Road Users (VRU): Users like pedestrians, including people with disabilities or visual impairment, cyclists and two wheelers exposed to high risk on the road.

Work Zone: Work zone or construction zone is the area where the construction activity is undertaken. Speed of the moving traffic in this zone should be limited to 30km/hr.

6 Bibliography

- (MoUD), M. o. U. D., 2012. *Public Transport Accessibility Toolkint*, s.l.: MoUD.
- (WHO), W. H. O., 2011. *Health economic assessment tools (HEAT) for walking and cycling*, s.l.: s.n.
- Agarwal, A. & Chakravarti, D., 2014. *Universal Accessibility Guidelines for Walkability, Non Motorised Transport and Public Transport Usage - Draft Report*, New Delhi: Samarthyam.
- Arora, A., 2010. *Bicycle Infrastructure Design Manual for Indian Sub-Continents*, s.l.: s.n.
- Associates, W. S., 2008. *Study on traffic and transportation : policies and strategies on urban areas in India*, s.l.: Ministry of Urban Development.
- Austroroads, 2002. *Guide to Road Safety Audit : Part 6- Road Safety Audit*, s.l.: Austroroads.
- BIS, B. o. I. S., 1981. *BIS 1944-7:1981, Code of practice for lightning of public thoroughfare*. New Delhi: s.n.
- County, C. C., 2005. *Pedestrian Access and Mobility - a code of practice*. 2nd ed. s.l.: Council Cheshire County.
- CROW, 1996. *Sign up for the bike : Design manual for a cycle friendly Infrastructure - Record 10*. s.l.: CROW.
- CROW, June 2007. *Record 25 : Design manual for bicycle traffic*. s.l.: CROW.
- EPTRI, E. P. T. a. R. I., 2005. *Integrated Environmental Strategies - Study for the city of Hyderabad*, s.l.: s.n.
- Fagard, R., 1995. Prescription and results of physical activity.. *J Cardiovasc Pharmacol*, Volume 25, pp. S20-S27.
- G.Tiwari, D., 2012. *NMT Infrastructure in India, Investment Policy and Design - draft Report*, s.l.: UNEP RISO Center.
- Gadepalli, S., 2008. *Evaluating the Impact of Free Left Turns on Traffic Behavior at Signalised Intersections*, Delhi: IIT.
- Ghate, A. T. & Sundar, S., 2010. *Infrastructure Development in a Low Carbon Economy*, New Delhi: Oxford University Press..
- Government of India, 2005. *NUTP, National Urban Transport Policy*, s.l.: Ministry of Urban Development.
- H. Jain, G., 2008. *Revised Bicycle Master Plan of Delhi*, s.l.: TRIPP.
- Hillsdon M, T. M. A. T. M. J., 1995. RCTs of physical activity promotion in free living populations: a review.. *J Epidemiol Community Health*, Volume 49, pp. 448-453.
- Indian Roads Congress (IRC), M. o. R. T. & H. (., 2012. *IRC:67, Code of Practice for road signs*. 3rd ed. s.l.: IRC.
- IRAP, i. R. A. P., 2009. *Star rating Roads for Safety - IRAP methodology*, s.l.: IRAP.
- IRC106, 1990. *IRC 106, Guidelines for Capacity of Urban Roads in Plain Areas*, New Delhi: IRC.
- IRC11, 1962. *IRC: 11, Recommended practice for the design and layout of cycle tracks*, New Delhi: IRC.
- IRC35, 1970. *IRC: 35, Guidelines for cyclists crossings*, New Delhi: IRC.
- IRC35, 1997. *IRC: 35 Code of practice for road markings*, New Delhi: IRC.
- IRC67, 2001. *IRC: 67, Code of practice for road signs*, New Delhi: IRC.
- IRC69, 1977. *IRC: 69, Space standards for roads in urban areas, i, India,,* New Delhi: IRC.
- IRC70, 1977. *IRC:70, Guidelines on regulation and control of mixed traffic in urban areas*, New Delhi: IRC.
- IRC86, 1983. *IRC: 86, Geometric design standards for roads inurban areas*, New Delhi: IRC.
- IRC92, 1985. *IRC: 92, Guidelines for the design of interchanges in urban areas*, New Delhi: IRC.

- IRC98, 1997. *IRC: 98, Guidelines on accommodation of utility services on roads in urban areas*, New Delhi: IRC.
- IUT, 2012. *Code of Practice - 2*. s.l.:MoUD.
- Jain, H., 2013. *Development of a bicycle demand estimation model incorporating land use sensitive parameters: case of Pune city, India*, s.l.: PHD Dissertation, IIT Delhi.
- JnNURM, G., 2005-12. *JnNURM*, s.l.: s.n.
- Mohan, D., 2008. Health Issues in Bicycling. In: *Bicycling in Asia*. s.l.:Interface for Cycling Expertise, pp. 117-120.
- Mohan, D., Tiwari, G. & Mukherjee, S., 2012-13. *A STUDY ON COMMUNITY DESIGN FOR TRAFFIC SAFETY*, s.l.: TRIPP.
- MOSTH, I.-D. D. A. I. o. T., 2000. *Traffic Calming Report (MOST Research Scheme T-3), State of the Art Report*. s.l.:Ministry of Surface Transport and Highway.
- MoUD, 2012. *Design of Urban Roads , Code of Practice (Part-4)*. s.l.:Ministry of Urban Development.
- MoUD, 2012. *Design of Urban Roads, Code of Practice -1 : Cross section*. s.l.:MoUD.
- MoUD, 2012. *Service Level benchmarks for Urban Transport*, s.l.: MoUD.
- MoUD, M. o. U. D., 2012. *Urban Road Safety Audit Development of Toolkit under “Sustainable Urban Transport Project “*; s.l.: Ministry of Urban Development.
- NHAI, T., 2014. *Work Zone Safety Manual*, s.l.: National Highways Authority of India, NHAI.
- NMSH, N. M. o. S. H., 2011. *Report of the Sub-Committee on Urban Transport*, s.l.: s.n.
- PMC, 2006. *Network Development for Bus Rapid Transit in Pune City: Main report*, Pune: Pune Municipal Corporation.
- RITES, 2008. *Delhi Survey*, s.l.: s.n.
- Singh, G., 2011. *Comprehensive Assessment of Cycle Tracks in Pune*, s.l.: Parisar.
- SP:55, I., 2013. *SP 55, Indian road Congress*, s.l.: IRC.
- Standards, B. o. I., 1981. *IS 1944-7 : Code of Practice for lightning of public thoroughfare*. New Delhi: s.n.
- Thompson MJ, R. F., 2001. Bicycle-Related Injuries. *American Family Physician* , 2007(14), p. 63(10).
- Tiwari, G., 2002. Urban Transport Priorities: Meeting the Challenge of Socio-economic Diversity in Cities, a Case Study of Delhi, India. *Cities*, 19(2).
- Tiwari, G. & Jain, D., n.d. Impact of transport infrastructure improvement strategies on Co2 emission and fuel consumption: Case of Indian cities.
- Tiwari, G. & Jain, H., 2008. Bicycling in Urban India. In: *Bicycling in Asia*. s.l.:Interface for Cycling Expertise,I-ce, Netherlands, pp. 9-26.
- Tiwari, G. & Jain, H., 2008. *Revised Bicycle Master Plan of Delhi*. Delhi: TRIPP.
- Tota, K., April 1999. *The role of non-motorized transport in sustainable urban transport systems: A preliminary analysis of costs and benefits of non-motorized and bus priority measures on Vikas Marg, Delhi, prepared for TERI.*, s.l.: s.n.
- TRIPP, 2006. *Survey report, Bicycle use and barriers to use, Transportation Research and Injury Prevention Program (TRIPP) IIT Delhi, Institute of Democratic Studies (IDS) for LOCOMOTIVES (I-ce) project*, s.l.: s.n.
- TRIPP, 2011. *Potential Trip Estimation Using SP Survey*, s.l.: TRIPP, IIT Delhi.
- TRIPP, n.d. *Work Zone Safety Manual*, s.l.: IIT - Delhi.
- TRIPP, R., 2005. *First Delhi BRT Corridor - A design Summary- Ambedkar Nagar to Delhi Gate*, New Delhi: s.n.

UNEP, 2012. *Low Carbon Mobility Plan, Visakhapatnam, Draft Final Report*, s.l.: s.n.

UNEP, I. D., 2012. *Toolkit for preparing Low carbon Comprehensive Mobility Plan (LCMP)*, s.l.: UNEP.

Woodcock, J., Mohan, D. & Tiwari, G., 2009. Public health benefits of strategies to reduce greenhouse-gas emissions : urban land transport. *Lancet*, Issue 374, pp. 1930-43.



The Transportation Research and Injury Prevention Programme (TRIPP) at Indian Institute of Technology Delhi (IITD) is an interdisciplinary programme focussing on the reduction of adverse health effects of road transport. TRIPP attempts to integrate all issues connected with transportation in order to promote safety, cleaner air, and energy conservation. Faculty members are involved in planning safer urban and inter-city transportation systems, and developing designs for vehicles, safety equipment and infrastructure for the future. Activities include applied research projects, special courses and workshops, and supervision of student projects at post-graduate and undergraduate levels. Projects are done in collaboration with associated departments and centres at IIT, Delhi, government departments, industry and international agencies.



Shakti Sustainable Energy Foundation works to strengthen the energy security of the country by aiding the design and implementation of policies that encourage energy efficiency as well as renewable energy. Based on both energy savings and carbon mitigation potential, we focus on four broad sectors: Power, Transport, Energy Efficiency and Climate Policy. We act as a systems integrator, bringing together key stakeholders including government, civil society and business in strategic ways, to enable clean energy policies in these sectors.

The views and analyses represented in this document do not necessarily reflect that of Shakti Sustainable Energy Foundation. The Foundation accepts no liability for the content of this document, or for the consequences of any actions taken on the basis of the information provided.



WHO COLLABORATING CENTRE



Transportation Research & Injury Prevention Program
Indian Institute of Technology, Delhi
New Delhi – 110016

<http://tripp.iitd.ernet.in>



Shakti Sustainable Energy Foundation

www.shaktifoundation.in