



TRANSPORTATION RESEARCH AND INJURY PREVENTION PROGRAMME

**FIRST DELHI BRT CORRIDOR  
A DESIGN SUMMARY  
AMBEDKAR NAGAR TO DELHI GATE**



WHO COLLABORATING CENTRE



**DECEMBER 2005**



INDIAN INSTITUTE OF TECHNOLOGY DELHI

## **PROJECT TEAM**

### **TRIPP**

Dr. Geetam Tiwari	Associate Professor TRIPP
Prof. Dinesh Mohan	Prof. Coordinator TRIPP
Mr. Sandeep Gandhi	Project Scientist
Mr. B. Sriram	Project Scientist
Ms. Sonia Kapoor	Project Associate
Ms. Ruchi Verma	Project Associate
Mr. Dheeraj Gupta	Senior Project Assistant
Mr. Mahesh Gaur	Data Manager

### **UTES**

Mr. A. K. Arora	Group Gen. Manager (Urban Transport)
Mr. Sanjay Rastogi	Gen. Manager (Urban Transport)
Mr. Piyush Kansal	Additional Gen. Manager (Urban Transport)
Mr. Pankaj Kumar	Deputy Gen. Manager (Urban Transport)
Mr. A. P. Sharma	Manager
Mr. Rajneesh Porwal	Manager
Mr. Abhay Negi	Assistant Manager

### **SUPPORT**

i'us: Designers' Combine	Design Service
--------------------------	----------------

**FIRST DELHI BRT CORRIDOR  
A DESIGN SUMMARY: AMBEDKAR NAGAR TO DELHI GATE**

**TABLE OF CONTENTS**

TABLE OF CONTENTS .....	2
LIST OF FIGURES .....	3
LIST OF TABLES .....	4
1. INTRODUCTION .....	5
1.1 IDENTIFICATION OF BRT CORRIDORS.....	5
1.2 Bus Lane Location .....	7
1.3 Location of Bus Shelter (for central bus lanes) .....	10
1.4 Location of Cycle Tracks.....	12
1.5 Signal Cycles at the Junction .....	15
1.6 Pedestrian Paths .....	15
2. Design Specifications.....	17
2.1 Bus Lanes.....	17
2.2 Motor Vehicular (MV) Lanes .....	20
2.3 Non Motorized Vehicular (NMV) Lanes.....	23
2.4 Pedestrian Paths .....	30
2.5 Service Lane and Parking .....	33
2.6 Hawkers and Vendors .....	35
3. Proposed Sample Designs for Ambedkar Nagar to Delhi Gate Corridor .....	41
3.1 Overview of Geometric Details of Ambedkar Nagar to Delhi Gate Corridor .....	41
3.1.1 Bus Shelters .....	45
3.1.2 Bus Lanes.....	45
3.1.3 MV lanes.....	45
3.1.4 NMV Lanes.....	45
3.1.5 Pedestrian Path.....	46
3.1.6 Service Lanes .....	46
3.2 Andrews Ganj Junction.....	46
3.3 Moolchand Junction.....	49
3.3 Defense Colony Pedestrian Subway .....	55
3.4 Tilak Bridge and ITO crossing .....	56
4. Signalization Plans.....	57
4.1 Existing Traffic .....	57
4.1.1 Traffic Volume.....	57
4.2 Junctions .....	57
4.4 Bus Commuters.....	60
4.5 Proposed Signalization Plans.....	60
4.6 Impacts.....	62
4.6.1 Traffic Volume and Speed .....	62
4.6.2 Pedestrian Delays.....	63
4.6.3 Safety .....	63

## LIST OF FIGURES

Figure 1: Map of Delhi showing the location priority BRT and ETB corridor.....	6
Figure 2: Commuters currently undertake very unsafe crossings at all side bus shelters on Ambedkar Nagar to Delhi Gate Corridor.....	10
Figure 3: Non Motorized vehicles (NMVs) occupy the left most lane on Ambedkar Nagar to Delhi Gate Corridor. ....	12
Figure 5: Plan showing Parallel bus lanes and shelters at junction bus shelters.....	20
Figure 5: Detail section showing segregation between cycle track and MV lanes.....	28
Figure 6: Detail plan for entry exit to service and side lanes.....	28
Figure 7: Plan showing entry exit to cycle track at junctions .....	28
Figure 8: Detail cross section of cycle track entry at (on the off side of) junction.....	29
Figure 9: Detail elevation of cycle track entry at (on the off side of) junction.....	29
Figure 10: Raised platform treatment for pedestrian paths across entrance/exit to side lanes and service lanes in Bogota, Columbia.....	33
Figure 11: Detail plan of hawker space showing edge treatment and floor finishes (option1) .....	38
Figure 12: Detail plan of hawker space showing edge treatment and floor finishes (option2) .....	39
Figure 13: Detail section through hawker space.....	40
Figure 14: Plan showing design of hawker spaces adjacent to MV lanes and Cycle track .....	40
Figure 15: Detail section of hawker space between cycle track and MV lane .....	40
Figure 16: Ambedkar Nagar to Delhi Gate Corridor-Schematic Plan.....	41
Figure 17: Proposed cross sections (facing Delhi Gate side) of Ambedkar Nagar to Delhi Gate BRT corridor (refer figure 16 for location of cross section ‘CS’ on plan).....	42
Figure 18: Proposed BRT design for Andrews Ganj Junction. ....	46
Figure 19: Andrews Ganj intersection signal cycle; phase 1, length 55 second – MV movement in all direction. ....	47
Figure 20: Andrews Ganj intersection signal cycle; phase 2, length 20 second – Pedestrian movement in all directions.....	48
Figure 21: Andrews Ganj intersection signal cycle; phase 3, length 55 second – MV and bus movement.....	48
Figure 22 : Andrews Ganj intersection signal cycle; phase 4, length 20 second – Pedestrian movement for all directions. ....	49
Figure 23: Proposed design for BRT at Moolchand intersection .....	50
Figure 24: Proposed design for BRT at Defense colony underpass and mid-block bus shelter .....	55
Figure 25: Proposed design for BRT at Tilak Bridge and ITO intersection.....	56
Figure 26: Line diagram of the corridor representing location and type of junction.....	58
Figure 28: Existing commuter activity along the proposed BRT corridor from Ambedkar Nagar to Delhi Gate. ....	60
Figure 29: Typical signal phase diagram for a 3 armed junction on the proposed BRT corridor .....	61
Figure 30: Typical signal phase diagram for a 4 armed junction on the proposed BRT corridor .....	61
Figure 31: Comparative improvement in corridor capacity for existing, optimized BRT and BRT with route rationalization. ....	62
Figure 32: Comparative improvement average speeds for existing corridor (in blue) and the proposed BRT corridor (in maroon). ....	62
Figure 33: Comparative pedestrian delays on seven junctions on the proposed BRT corridor.....	63
Figure 34: Expected reduction in fatalities of bus commuters, cyclists and pedestrians.....	63

## LIST OF TABLES

Table 1: Priority BRT corridors for Delhi .....	5
Table 2: Priority ETB corridors for Delhi.....	6
Table 3: Rationale for choosing side or central bus lanes. ....	7
Table 4: Prioritization for space allocation on the right of way. ....	9
Table 5: Width of cycle track with respect to its usage. ....	13
Table 6 : Objective speed for one way bus carriageway or lane on a straight section .....	17
Table 7: Desired traffic lane widening for public service buses on bends. ....	18
Table 8: Maximum acceptable surface irregularities on bikeways.....	26
Table 9: Maximum grade lengths for bicycle paths with grades in excess of 5% .....	27
Table 10: Effective capacity for width of pedestrian paths. ....	30
Table 11: Cumulative percentage of mobility impaired people observed to be unable to move more than the stated distance in city centres without rest.....	31
Table 12: Permissible Longitudinal Grade and Length for pedestrian path and wheel chair ramps (a landing minimum 1.5m long is recommended after this length). ....	32
Table 13: Existing junctions, pedestrian subways and bus shelters on various sections of the corridor.....	41
Table 14: Existing and proposed cross sections .....	42
Table 15 summary of proposed bus shelters (parallel shelters).....	45
Table 16:Direction wise comparison of weaving lengths for cars and buses for existing bus system (bus shelter locations) and proposed BRT system (junction bus shelters) .....	51
Table 17: Comparison of walking distances for interchanging pedestrians between public transport streams for existing and proposed (BRT) geometric design and location of bus shelters .....	54
Table 18: Traffic volume and Modal split at ITO Junction .....	57

# 1. INTRODUCTION

Delhi Government has initiated the implementation of Bus Rapid Transit (BRT, also termed as High Capacity Bus System). Transportation Research and Injury Prevention Programme (TRIPP, at Indian Institute of Technology) and RITES Ltd., Delhi have been entrusted the task for planning and designing this system.

## 1.1 IDENTIFICATION OF BRT CORRIDORS

The Committee on Sustainable Transport, chaired by the then Chief Secretary, and consisting of senior transport department officials, GOI officials, with transportation experts from consulting and academic fields, in its Report in 2001-2002, recommended taking up these 14 road corridors for implementation of Bus Priority Schemes. These were selected based on:

- The available right-of way of major road/corridor and
- The present level of bus services operated on such corridors,

Out of the initial 14 corridors, inter-se priority was worked out, and five corridors (Figure 1) have been identified to be considered in the 1<sup>st</sup> Phase. Table 1 lists the first five priority corridors. This prioritisation has been carried out with a view to:

- Have a uniform distribution of these facilities through out the Delhi Urban Area
- Avoid duplication of such facilities on roads which are parallel to MRTS/IRBT corridors
- Ensure that the corridors, to the extent possible, have bus terminals at both ends.

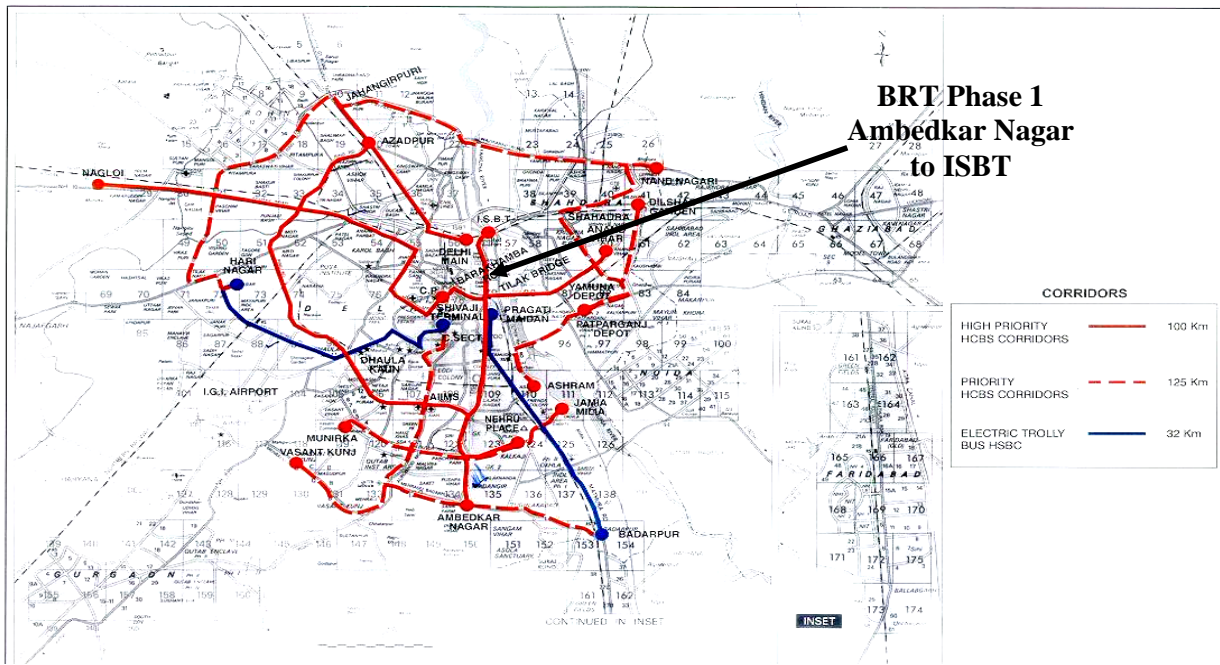
**Table 1: Priority BRT corridors for Delhi**

S.No.	BUS CORRIDORS	Length (Km)
1	Nangloi – Peeragarhi – Punjabi Bagh – Anand Parbat – Rani Jhansi Road – Link Road – Gole Market – Shivaji Terminal.	20
2	Azadpur – Wazirpur Industrial Area – Punjabi Bagh – Raja Garden – Naraina Vihar – Dhoola Kuan – Moti Bagh – South Extn. – Mool Chand – LSRC – Nehru Place	32
3	Jahangirpuri – Azadpur – Rana Pratap Bagh – Malkaganj – St. Stephen’s Hospital – Mori Gate – Old Delhi Rly. Stn.	12
4	Dr. Ambedkar Nagar – Masjid Moth – Mool Chand – Sundar Nagar - Appu Ghar – Delhi Gate – Lal Qilla – ISBT	19
5	Anand Vihar – Karkarduma Chowk – Swasthya Vihar – Lakshmi Nagar – ITO – Bara Khamba Road – Shivaji Terminal	15
TOTAL		98 ~100 Kms

2 corridors out of the 14 corridors were selected for implementation of Electric Trolley Bus (ETB) system (Figure 1). These are listed in Table 2.

**Table 2: Priority ETB corridors for Delhi**

S.No.	ETB CORRIDORS	Length (Km)
1	Hari Nagar Clock Tower Lajwanti Garden – Kirbi Place, Dhaula Kuan – SP Marg – Willingdon Crescent – Talkatora Stadium – Central Sectt.	16
2	Badarpur – Sarita Vihar – Ashram Chowk – Humanyu’s Tomb – Sundar Nagar – Pragati Maidan	16
TOTAL		32 kms



**Figure 1: Map of Delhi showing the location priority BRT and ETB corridor.**

An evaluation of various traffic and institutional parameters was carried out to identify one corridor each of bus and electric trolley bus for implementation as pilot project. The first BRT corridor identified for implementation from the evaluation of these corridors was the ‘Ambedkar Nagar to Delhi Gate Corridor’. The BRT concept for this corridor includes the following features:

- Segregated bus lanes in the centre of the Road, for uninterrupted traffic movement.
- Safe pedestrian and commuter movement at all locations.
- Segregation of slow traffic such as bicycles to ensure efficiency.

The designs presented here have evolved over the last four years, involving discussions with national and international experts and all stakeholders of Delhi. Annexure 1 presents list of meetings with various stakeholders and key decisions taken in these meetings.

The proposed design of this corridor is aimed at catering to the mobility needs for all road users in a safe and efficient environment. The exercise involved participation by many experts and stakeholders, in the form of workshops and meetings. The frequently asked questions and their answers listed below constituted a major component in the planning and conceptualization process. The issues have been categorized as following:

## 1.2 Bus Lane Location

**Issue 1:** Which location, side or central is efficient for the bus system?

**Explanation:** The following tables list the rationale and criteria for selecting side or central bus lanes:

**Table 3: Rationale for choosing side or central bus lanes.**

S.No.	Central Bus Lane	Curb-Side Bus Lane
1.	<b>Excessive side-entries for vehicles into service lanes or individual plots.</b>	<b>Limited access to service lanes or widely spaced entry points into adjoining area.</b>
Rationale	The high volume of turning traffic interferes with the through movement of bus traffic if the bus uses the same curb-side lane as the turning vehicles.	
2.	<b>Closely placed traffic lights for vehicles may be combined with bus shelters.</b>	<b>Traffic lights at larger intervals.</b>
Rationale	Buses using the curb-side lane are forced to stop at every red signal with other vehicles reducing throughput, therefore central bus lanes are preferred.	
3.	<b>Higher volume of two-wheeler and three-wheeler vehicles</b>	<b>Lower volume of two-wheeler and three-wheeler vehicles</b>
Rationale	High volumes of two-wheeler and three-wheeler vehicles interfere with the movement of buses in the curb-side lane especially at the bus-shelters where buses often cannot approach the designated bus-bays due to the three-wheelers parked there and the two-wheelers trying to overtake from the left-side. Also, the difference in sizes of these vehicles sharing the curb-side lane makes the situation unsafe for the smaller vehicles.	

**Conclusion:** Since the selected corridor fulfills all three criteria for central bus lanes, it is recommended that central segregated bus lanes be used in the proposed BRT system for Ambedkar Nagar to Delhi Gate.

**Issue 2:** Which system is suitable for increased commuter/pedestrian safety?

**Explanation:** In a curbside bus lane system approximately 50% of all commuters have to cross the road, either to take the bus or after leaving it; at present in very dangerous conditions (Figure 2). In a typical six lane divided urban arterial road, where the bus lanes for both directions are in the centre or curbside all commuters are required to cross a total of 12 lanes in a return trip. Since central bus lanes are segregated from motor vehicle lanes using medians, pedestrians/commuters need to cross only two lanes at a time generally at a safe controlled crossing. In case of side bus lanes at least 50% of the commuters have to cross all six lanes. This requires longer safe pedestrian crossing time which may increase accidents and increase signal cycle length adversely affecting the motorized vehicles(MV) flow.



**Conclusion:** Although both the probability of crossing and the total crossing distance in a return journey is the same in case of central and side bus lane BRT system, the distance between the safe refuge for crossing pedestrians is less in case of central bus lanes hence they are better for commuter/pedestrian safety.

**Issue 3:** Which system is more comfortable for commuters/pedestrians?

**Explanation:** Commuter comfort can be judged by reduced walking distance to access the system. Central bus lanes allow bus shelters to be placed at a maximum distance of 20 m from the junction. This reduces the walking distance of all commuters interchanging bus direction/routes at the junction and also and also for a majority of commuters accessing the system from their homes and workplaces on the side lanes. In case of side bus lanes, the bus shelters need to be placed at a minimum distance of 150m before/after the junctions to allow weaving between right turning buses and motor vehicle traffic at the junction. This also results in queuing leading to over spilling of bus lane on the junction in case the bus shelter is after the junction and reduced efficiency caused by buses stopping twice (once at the shelter and once at the red light) in case of before the junction side bus shelters.

**Conclusion:** Central Bus Lanes are better for commuter/pedestrian comfort.

**Issue 4:** Which system is better for safety, comfort and efficiency of other motor vehicles?

**Explanation:** Comfort, safety and efficiency of motor vehicles in the city of Delhi is hampered by the friction with slow moving vehicles, buses at bus shelters and encroachment on the carriageway by parked vehicles, hawkers etc. The BRT system with central bus lanes, proposes separate segregated lanes for non motorized vehicles (NMVs), and buses as well as continuous paths for pedestrians and designed spaces for parking and designated hawker activity zones. Such a design would streamline flow of other motorized vehicles making it safe efficient and comfortable.

**Conclusion:** Central segregated bus lanes and bus shelters along with segregated NMV tracks and dedicated spaces for parked vehicles and hawker activity are more comfortable, safe and efficient for motor vehicular traffic.

**Issue 5:** Which system is easier to implement on narrower right of way conditions?

**Explanation:** Both the side and central lane systems can be implemented in narrower right of way conditions by prioritizing allocation of available right of way. The table below discusses the method of prioritization for BRT corridor designs.

**Conclusion:** By modifying and fine tuning design details, both central and side bus lane system can be adapted for use in narrow right of way situations.

**Issue 6:** How does central bus lane design cope with the flyover situation?

**Explanation:** The physical segregation of the central bus lanes can be discontinued, minimum 150m from the foot of the flyover on both sides to allow for weaving between, motor vehicles using the flyovers and buses accessing the bus shelters under the flyover. These weaving designs are similar to those being used on new flyover designs in Delhi.

**Conclusion:** The physical segregation for central bus lanes is discontinued 150m on both sides from the foot of the flyover.

**Table 4: Prioritization for space allocation on the right of way.**

Cross Section Design  
Prioritization for Space Allocation  
**Space Allocation on ROW**

Between Bus Shelters (midblocks)	At Bus Shelter
<b>Priority 1:</b> Provide 3.1 to 3.5m wide bus lanes in each direction with a segregation by paint line with reflector studs to 600mm wide, 150mm high median (depending on the availability of space).	<b>Priority 1:</b> Provide 3.0m wide physically segregated or segregated by marking (if space is constrained) bus lanes
<b>Priority 2:</b> Cycle/Cycle rickshaw paths, 1.5 to 2.5m wide (2 way or 1 way as per availability of space) on both sides of the carriageway	<b>Priority 2:</b> 2m to 3.5m wide (depending on availability of space) bus shelters.
<b>Priority 3:</b> Pedestrian paths as per existing and future peak time demand (minimum 1.2m)	<b>Priority 3:</b> Cycle/cycle rickshaw paths, 1.5 to 2.5m wide (2 ways or 1 way as per availability of space) on both sides of the carriageway
<b>Priority 4:</b> 2 to 4 lanes for motorized vehicles (depending on the availability of space). The width of each lane may vary from 2.75m to 3.5m depending on the availability of space. Since the lane widths and numbers should not change between junctions (excluding locations 50 to 75 m before junction), the minimum available right of way between the junctions should be considered for design.	<b>Priority 4:</b> Pedestrian paths as per existing and peak time demand along the corridor (minimum 1.2m)
<b>Priority 5:</b> 3m to 6m wide segregated service lanes on both or single side of the carriageway depending on the availability of space and landuse conditions. Where space is very constrained but provision of service lane and parking is necessary, the texture and level of service lane and parking may be made similar to and combined with sidewalks, segregating where space permits, using bollards of various designs.	<b>Priority 5:</b> 2 to 4 lanes for motorized vehicles (depending on the availability of space). The width of each lane may vary from 2.75m to 3.5m depending on the availability of space. Since the lane widths and numbers should not change between junctions (excluding locations 50 to 75 m before junction), the minimum available right of way between the junctions should be considered for design.
<b>Priority 6:</b> Space for parallel/ perpendicular parking of MV/service vehicles on both or single side of the carriageway/service lane, depending on the availability of space	<b>Priority 7:</b> Bus parking bays/-overtaking lanes for buses
	<b>Priority 8:</b> 3m to 6m wide segregated service lanes on both or single side of the carriageway depending on the availability of space and landuse conditions. Where space is very constrained but provision of service lane and parking is necessary, the texture and level of service lane and parking may be made similar to and combined with sidewalks, segregating where space permits, using bollards of various designs.
	<b>Priority 9:</b> Space for parallel or perpendicular parking of motorized/service vehicles on both or single side of the carriageway service lane

Note: Other possibilities of one way traffic for motor vehicles and/or buses has not been considered for this corridor. This option would require a much lower right of way.

### 1.3 Location of Bus Shelter (for central bus lanes)

#### At the junction or away from it?

**Issue 1:** Where should bus shelters be located to minimize accidents?

**Explanation:** The existing bus shelter located away from the junctions increase the risk of accidents as they are not combined with safe pedestrian crossing infrastructure (Figure 2). The bus shelters in the proposed BRT system include safe pedestrian crossing infrastructure in the form of at grade signalized pedestrian crossing, or partial subways. At a signalized junction all bus shelters are accessed from at grade signalized pedestrian crossings or zebra crossings. The junction signal cycle is designed to provide pedestrian green face with a delay of less than 60 seconds. This would encourage pedestrians to use the pedestrian crossing during the safe phase of the signal cycle, minimizing the risk of accidents. Moreover since the bus infrastructure remains segregated from other motorized vehicles, both physically as well by the signal cycle the risk of any accidents caused by weaving motor vehicular and bus traffic is eliminated.

**Conclusion:** Physical infrastructure and signal cycles for buses shall be designed to make junction bus shelters safer and more convenient for all.



Figure 2: Commuters currently undertake very unsafe crossings at all side bus shelters on Ambedkar Nagar to Delhi Gate Corridor.

**Issue 2:** Which location of bus shelter (near or away from the junction) is more convenient for commuters?

**Explanation:** Commuter comfort can be judged by reduced walking distance to access the system. Bus shelters located at the interchange reduce the walking distance of all commuters interchanging bus direction/routes at the junction and also for a majority of commuters accessing the system from their homes and workplaces on both intersecting roads.

**Conclusion:** Bus shelters located close to the junction are convenient for commuters.

**Issue3:** Which location for bus shelter is more efficient for the BRT system; just before the junction or after/away from the junction?

**Explanation:** Buses need to stop at all bus shelters for 20 to 30 seconds to load/offload passengers. This time is known as the dwell time for buses. Buses also have to necessarily stop at all signalized junction if they encounter a red light, the probability of which is between 66 to 75%. By locating bus shelters just before the junction it is possible to combine the bus dwell time with the bus waiting time at the red light. This would reduce delays in the bus system and improve its average speed, making the whole system more efficient. In this system buses cannot overflow in to the junction.

**Conclusion:** Bus shelters located just before the junction in central bus lanes add to the efficiency of the BRT system.

**Issue 4:** Will Bus shelters located close to the junctions cause the junction to be congested?

**Explanation:** Both junction and mid block bus shelters are staggered along the length of the corridor. At the junction the bus shelters are provided before the stop line hence shelters for each direction are staggered on both sides of the junction. The geometric designs of the BRT system warrant the widening of the carriageway at the junction, adding turning pockets to MV lanes, providing dedicated bus and NMV lanes as well bus shelter by taking away space from service lane and parking on the edges. Such a system increases the number of lanes entering the junction by 25 to 100%, reducing the level of congestion from the existing system. By separating slow and fast road users, efficiency of crossing for all road users is increased at the junction.

**Conclusion:** Bus shelters located close to the junction have no effect on the level of congestion at the junction. The BRT system itself proposes to decongest all junctions on the corridor by introducing additional lanes and turning pockets on the carriageway entering the junction so as to increase the throughput of vehicles in every green phase by more than 25%.

**Issue 5:** Where should the bus shelters be located along the corridor?

**Explanation:** All bus stops generate the demand for pedestrian crossing to access the shelters. Thus shelters need to necessarily be combined with safe pedestrian crossings. Also bus commuter, boarding and alighting demand is highest at important junctions and nodes. This can be explained by the fact that junctions allow multi directional access to the commuters and also that it allows them to interchange between important bus routes and directions. Since junctions are signalized and allow safe pedestrian crossings, it is advisable that bus shelter be located before all signalized junctions (directly accessible by the pedestrian crossing). Also since a

comfortable walking distance for pedestrians accessing the bus shelter is 250 to 500m, it is advisable to space the bus shelters between 500 to 700m from each other.

**Conclusion:** Bus shelters should be located at all signalized intersection (on the before side), accessed directly from a signalized pedestrian crossing. The shelters should be spaced 500 to 700m from each other. If the signalized junctions are spaced at a distance greater than this, and if bus commuter demand exists between these two junctions, a mid block bus shelters with a safe pedestrian signalized (in case of at grade crossing) or grade separated access should be provided. Access to bus shelters should be barrier free from the sides.

**Issue 6:** Where should the bus shelter be located if the junction is spanned by a flyover?

**Explanation:** Since most commuters need to access the junction for route or direction interchange. It is advisable to provide the bus shelter at the junction under the flyover.

**Conclusion:** Bus shelters should be provide at the junction under the flyover (on the before side) directly accessible through safe signalized pedestrian crossing.

## 1.4 Location of Cycle Tracks

**Issue 1:** Should the cycle tracks be segregated?



**Figure 3:** Non Motorized vehicles (NMVs) occupy the left most lane on Ambedkar Nagar to Delhi Gate Corridor.

**Explanation:** Cyclists occupy the curb side lane in a mixed traffic situation. They share this lane with transport and goods vehicles, buses and three wheeled scooter taxis, leading to the risk of serious accidents (Figure 3). Accident data from Delhi show that bicyclists and pedestrians are at highest risk of getting involved in fatal accidents because of their conflict with buses in the curb side lane. The data show that often these accidents are with heavy transport and goods vehicles. Thus cycle track segregation is required on all roads with maximum speeds more than 50 km/h., according to all international design guidelines. Cycle track segregation also helps in improving the traffic flow of other motor vehicles. Even a low cycle volume, prevents motorists from using the curb side lane of the carriageway, as the speed differential between the two makes maneuvering between the cyclists almost impossible.

**Conclusion:** A segregated bicycle lane is mandatory on all roads with peak speeds of more than 50 km/h. This not only improves bicycle safety but also eliminates friction with motor vehicles improving its throughput.

**Issue 2:** What is the ideal width of cycle tracks?

**Explanation:** Cycle tracks are used not only by cyclists but by passenger and goods cycle rickshaws and hand carts. The width used by each is as following:

Bicycle – 0.75m

Passenger cycle rickshaw – 0.95m

Goods Cycle Rickshaw – 1.20m

Based on these the minimum and the comfortable width required to allow two way traffic for is given in table 5.

**Table 5: Width of cycle track with respect to its usage.**

S.No.	Used by?	Min. Width	Comfortable Width
1.	Bicycles only	1.5m	1.8m
2.	Bicycles and Passenger Rickshaws	1.8m	2.0m
3.	Bicycles and Goods Rickshaws	2.0m	2.2m
4.	Passenger and Goods Rickshaw	2.2m	2.5m
5.	Heavy Goods Rickshaw traffic	2.5m	3.0m

In case of cycle volumes of more than 5000 cyclists per hour (for both direction traffic) cycle track width, wider than 3.0m may be required. However for lower volumes it is not advisable to have widths of cycle tracks less than 1.5m or more than 2.5. A lesser width will discourage bicycle use; a higher width would encourage encroachment by other functions such as parking and through two wheeler traffic.

**Conclusion:** Width of segregated cycle tracks may vary from 1.5m to 2.5m depending on bicycle traffic and site constraints.

**Issue 3:** Can service lanes serve as cycle tracks?

**Explanation:** No. Service lanes serve a specific function. These lanes are for slow movement of vehicles meant either for parking or to access properties. Vehicles existing from houses cause conflict with bicycle users. A conflict with such functions is both uncomfortable and unsafe for bicyclists. Since bicyclists are main stream commuters, use of service lanes as against a separate bicycle track or the main carriageway will add to their delays and increase their journey time. In case of rickshaws, also rickshaw pullers need sufficient energy to achieve their cruising speed, frequent braking and slowing in service lanes will add considerably to their

fatigue and reduce their efficiency. Experience from Delhi shows that bicyclists avoid using service lanes.

**Conclusion:** Cycle tracks need to be distinct and segregated from all other functions and paths on the road.

**Issue 4:** What is the ideal location of the cycle track along the road-cross section?

**Explanation:** Cyclists are main stream commuters. They seldom trust lanes or paths which are away from the carriageway or likely to be poorly maintained or terminate suddenly. Hence the cycle path should be at similar level as the carriageway and visually and physically close the motor vehicle lanes. The cyclists should have an option of joining the main carriageway whenever he/she wishes.

**Conclusion:** Cycle path should be provided adjacent to the motor vehicular lanes, segregated by a median which is mountable by the cyclists.

**Issue 5:** Can cycle tracks be on one side of the road only? Should they be two way?

**Explanation:** In an urban area, functions creating origin destination demand for cyclists exist on both sides of the carriageway. Bicycle users go to the same destination as car users. Since junctions on a road are spaced by 0.5 to 1.0 km, it is not feasible for most cyclists to cycle extra for up to a km and take a 'U' turn at a junction to join the track for his/her direction of movement. NMVs would primarily travel opposite to the traffic flow to the nearest junction in case their journey direction is opposite to the side of the road at the origin.

**Conclusion:** Separate segregated cycle tracks should be provided on both sides of the road. Also the cycle tracks may be designed primarily for one way usage but use by NMVs for opposite direction movement should not be obstructed

**Issue 6:** Do cyclists require a separate signal phase at the junction:

**Explanation:** Since traffic starting after a red light at the junction is slower in speed, cyclists can be combined with motor vehicles at the junction eliminating the need of a separate phase. A 5m long cycle box should be painted in front of the stop line on the MV lanes before the junction to indicate holding space for the cyclists at the junction. Free left turns while banned for motor vehicles should be permitted for cyclists.

**Conclusion:** Cyclists do not need a separate signal phase at the junction.

**Issue 7:** What is the ideal surfacing material for cycle tracks?

**Explanation:** Unlike motor vehicles, cycles and cycle rickshaws do not have shock absorbers. It is therefore advisable to provide smooth riding surface to the cyclists. However surfacing material such as asphalt requires frequent maintenance which because of its width (narrower than a Motor Vehicle lane) is difficult as it restricts the use of pavers. It is therefore advisable to pave the cycle lanes in cement concrete with minimum vertical and horizontal difference between slabs at joints to be within permissible comfort levels.

**Conclusion:** Cycle tracks should be constructed in cement concrete, where they are narrower than 3.5m in width.

**Issue 8:** Is it important to maintain the continuity of cycle tracks?

**Explanation:** Cyclists are main stream commuters; hence they try to reduce delays and journey time. Bicyclists encounter delays and confusion at the entry and exit of discontinuous cycle infrastructure (in parts), which discourages its use by non

motorized vehicles. In order to provide direct and continuous cycle paths through narrower right of ways, it is advisable to adjust the width and functions of service lanes, to release adequate space for the bicycle network.

**Conclusion:** Cycle tracks should be continuous, direct and attractive to use.

**Issue 9:** Do we need specific treatment at entry and exit to bicycle lanes?

**Explanation:** Entry and exit points to bicycle tracks should be safe and should discourage encroachment of motorized vehicles on cycle lanes for parking and thoroughfare. Raised platform (at the level of pedestrian path) treatment, is proposed, to reduce conflicts between NMVs and MVs at punctures to cycle tracks near entry/exit to side lanes, properties and service lane. At junctions, where cyclists enter the cycle track in large groups (after each red light), and slower, wider cycle rickshaws restrict entrance to the track, the segregation between NMV and MV lane should be setback by a minimum of 30m. Independent bollards or curbstones spaced at an interval of 1.5 to 2.0m should be used to define the cycle path for this length.

**Conclusion:** Bicycle track entry and exit should be carefully designed to maintain directness and continuity of NMV lanes, encourage cyclists and discourage encroachment by motor vehicles.

## 1.5 Signal Cycles at the Junction

**Issue 1:** What should be the maximum signal cycle length at the junction?

**Explanation:** The throughput of the junctions keeps increasing with the increase in signal cycle time to a maximum limit of 180seconds. Beyond which the throughput of the junction shows a reduction trend.

**Conclusion:** The maximum signal cycle length at the junction should be 180 seconds.

**Issue 2:** Do we need to signalize the left turning traffic at the junctions:

**Explanation:** Junctions are not only locations for crossing motor vehicles, they are the locations where pedestrians and cyclist crossing demand is the highest. In order to be safe pedestrians are required to cross the carriageway when motor vehicular traffic on that arm has stopped at the red light. In case of free left turns this is never possible. It is therefore strongly advised that all junctions allow safe pedestrian and bicyclist movement by signalizing all motor vehicular movement including left turns.

**Conclusion:** All junctions should have signalized left turns.

## 1.6 Pedestrian Paths

**Issue 1:** What should be the minimum width of pedestrian paths?

**Explanation:** According to the Highway Capacity Manual (HCM) 2000, Transportation Research Board (TRB), US, the pedestrian facilities can be classified according to 6 levels of service i.e. from A to F. Comfortable pedestrian facilities in Delhi city could either have a level of service C or D. These are:

*LOS C – Pedestrian space > 2.2 – 3.7 m<sup>2</sup>/p. Flow rate <= 23 – 33 p/min/m*



*At LOS C, space is sufficient for formal walking speeds, and for bypassing other pedestrians in primarily unidirectional streams. Reverse direction or crossing movements can cause minor conflicts, and speeds and flow rate are somewhat lower.<sup>1</sup>*

**LOS D – Pedestrian Space > 1.4-2.2 m<sup>2</sup>/p. Flow Rate > 33-49 p/min/m**

*At LOS D, Freedom to select individual walking speed and to bypass other pedestrians is restricted. Crossing or reverse flow movements face a high probability of conflicts requiring frequent changes in speed and position. The LOS provides reasonably fluid flow, but friction and interaction between pedestrians is likely.<sup>1</sup>*

The effective width of the walkway is the total width minus the width of obstructions plus the shy away distance. The approx. width preempted of objects such as light pole and tree are 0.6 to 1.2m<sup>1</sup>. Overall, the relationship between expected pedestrian traffic and the effective walk way width required for their comfortable movement as per LOS C or LOS D is as following:<sup>1</sup>

$$V_p = V_{15} / 15 * W_E$$

Where

$V_p$  = pedestrian unit flow rate (p/min/m)

$V_{15}$  = peak 15-min flow rate(p/15-min), and

$W_E$  = effective walkway width (m)

For a stretch on the corridor which receives only pedestrian traffic accessing the public transport,  $V_{15}$  is not expected to be more than 75 based on 10% to and fro traffic to a bus (with a capacity of 100), and bus volume as 1 bus every 2 min.

Assuming the flow rate or  $V_p$  to be 33 (from LOS values), the effective pedestrian path width should be:

$$\begin{aligned} W_E &= V_{15} / 15 * V_p \\ &= 75 / 15 * 33 \\ &= 0.15m \end{aligned}$$

Since required width for to pedestrians to cross is 1.5m, it is advisable that the minimum width of the pedestrian path be 1.5

**Conclusion:** The minimum clear width of the pedestrian path should be 1.5m

---

<sup>1</sup> Transportation Research Board, US, Highway Capacity manual, 2000, Chapter 11, Pedestrians and Bicycle Concepts, Page 11-9

## 2. Design Specifications

Design specifications have been developed specific to the requirements of each road user: bus commuters, motor vehicles, Non-motorized vehicles, pedestrians and hawkers. These specifications have been contextualized to Indian conditions and needs and are broadly based on International Guidelines.

### 2.1 Bus Lanes

S.No.	Title	Specifications												
1.	<b>Location</b>	Segregated Bus Lanes should be located in the middle of the carriageway, for both direction traffic.												
2.	<b>Entry/Exit</b>	Physical segregation between bus and MV lanes on the after side of the junction should be set back by 12 to 30m. Bus lanes segregation along this length should be achieved using pavement marking and reflector studs. This design detail s intended to prevent motor vehicles from accidentally entering the corridor and getting trapped in the bus lane.												
3.	<b>No. of Lanes</b>	A single continuous bus lane between the junctions and a two parallel (3m wide each) bus lane at the junction (or the bus shelters) is proposed for the corridor.												
4.	<b>Bus Shelter</b>	<ul style="list-style-type: none"> <li>40m to 56m long parallel bus shelters should be used at junctions (with a total capacity of 6 to 8 buses).</li> <li>Mid block bus shelters may either be of parallel type or linear with overtaking lane on the left side of the bus shelter. The length of mid block bus shelter shall be 40m to 56m, depending on the site constraints and the capacity required.</li> </ul>												
5.	<b>Size</b>													
a.	Width	<p>Bus lane width should be as following:</p> <p><b>Table 6 : Objective speed for one way bus carriageway or lane on a straight section<sup>2</sup></b></p> <table border="1"> <thead> <tr> <th></th> <th>Objective speed in km/hr</th> <th>Desired Carriageway width (m)</th> <th>Minimum carriageway width (m)</th> </tr> </thead> <tbody> <tr> <td>Wide Right of way – residential or institutional land use</td> <td>50</td> <td>3.50</td> <td>3.30</td> </tr> <tr> <td>Narrow Right of way – commercial/ shopping street</td> <td>30</td> <td>3.30</td> <td>3.10</td> </tr> </tbody> </table>		Objective speed in km/hr	Desired Carriageway width (m)	Minimum carriageway width (m)	Wide Right of way – residential or institutional land use	50	3.50	3.30	Narrow Right of way – commercial/ shopping street	30	3.30	3.10
	Objective speed in km/hr	Desired Carriageway width (m)	Minimum carriageway width (m)											
Wide Right of way – residential or institutional land use	50	3.50	3.30											
Narrow Right of way – commercial/ shopping street	30	3.30	3.10											

<sup>2</sup> CROW, Record 15, Recommendations for Traffic Provisions in Built Up Areas, ASVV, Chapter 7.3, Traffic Engineering Aspects of Public Bus Transport, Table 7.3/2, Page 345

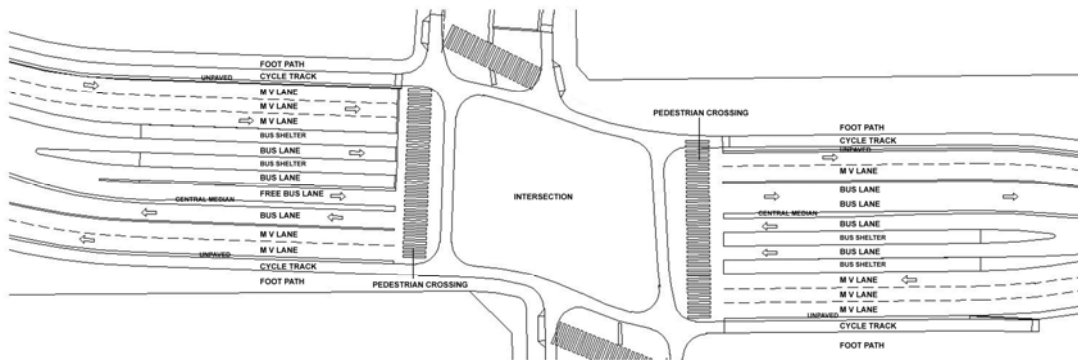
		<ul style="list-style-type: none"> <li>• Exceptions: Lane widths for segregated bus lanes should be increased when road section is bending or curving</li> </ul>																																										
		<p><b>Table 7: Desired traffic lane widening for public service buses on bends<sup>3</sup>.</b></p> <table border="1"> <thead> <tr> <th>Radius (m)</th> <th>Total traffic lane widening (m)</th> <th>Radius (m)</th> <th>Total traffic lane widening (m)</th> <th>Radius (m)</th> <th>Total traffic lane widening (m)</th> </tr> </thead> <tbody> <tr> <td>&lt; 9</td> <td>3.30</td> <td>30-35</td> <td>1.35</td> <td>70-80</td> <td>0.55</td> </tr> <tr> <td>9-13</td> <td>3.10</td> <td>35-40</td> <td>1.15</td> <td>80-100</td> <td>0.50</td> </tr> <tr> <td>13-16</td> <td>2.70</td> <td>40-45</td> <td>1.00</td> <td>100-150</td> <td>0.40</td> </tr> <tr> <td>16-20</td> <td>2.30</td> <td>45-50</td> <td>0.85</td> <td>150-300</td> <td>0.25</td> </tr> <tr> <td>20-25</td> <td>2.00</td> <td>50-60</td> <td>0.75</td> <td>&gt;300</td> <td>0</td> </tr> <tr> <td>25-29</td> <td>1.60</td> <td>60-70</td> <td>0.65</td> <td></td> <td></td> </tr> </tbody> </table> <ul style="list-style-type: none"> <li>• Width of bus lanes immediately after the junction should be widened as per the table above (if buses are required to bend through the intersection in order to align to the bus lane on the other side of the junction). Such a widening should continue for a minimum length of 12m in the bus lane.</li> <li>• 3m wide bus lanes are proposed at parallel; mid-block and junction bus shelters. The width of the bus path at the level of 'rear-view-mirrors' shall be a minimum of 3.3m. Also the use of guides for bus tires is recommended to keep the bus body clear of the shelter and other obstructions.</li> <li>• The width of overtaking lane for buses at the mid block bus shelters shall be a minimum of 3.3m.</li> </ul>	Radius (m)	Total traffic lane widening (m)	Radius (m)	Total traffic lane widening (m)	Radius (m)	Total traffic lane widening (m)	< 9	3.30	30-35	1.35	70-80	0.55	9-13	3.10	35-40	1.15	80-100	0.50	13-16	2.70	40-45	1.00	100-150	0.40	16-20	2.30	45-50	0.85	150-300	0.25	20-25	2.00	50-60	0.75	>300	0	25-29	1.60	60-70	0.65		
Radius (m)	Total traffic lane widening (m)	Radius (m)	Total traffic lane widening (m)	Radius (m)	Total traffic lane widening (m)																																							
< 9	3.30	30-35	1.35	70-80	0.55																																							
9-13	3.10	35-40	1.15	80-100	0.50																																							
13-16	2.70	40-45	1.00	100-150	0.40																																							
16-20	2.30	45-50	0.85	150-300	0.25																																							
20-25	2.00	50-60	0.75	>300	0																																							
25-29	1.60	60-70	0.65																																									
b.	Length	Continuous – unless weaving with motor vehicles is required such as locations at the foot of flyover in which case physical segregation should be replaced with pavement markings																																										
6.	<b>Edge Treatment</b>	<p>Segregation from MV Lanes:</p> <ul style="list-style-type: none"> <li>• Bus lanes may be segregated from motor vehicular lanes using curb stones of the following specifications:</li> <li>• The height of curb stones used should be necessarily less than 0.15m.</li> <li>• The edge facing bus lanes should be sloping so as to allow buses to exit the lane or to be pulled out in case of break down or other emergency.</li> <li>• The width of this edge/median should be preferably 0.6m (to serve as a refuge island for crossing pedestrians). The minimum width of this segregation for short stretches can</li> </ul>																																										

<sup>3</sup> CROW, Record 15, Recommendations for Traffic Provisions in Built Up Areas, ASVV, Chapter 4.3, Traffic Engineering Premises, Table 4.3/7, Page 124

		<p>be 0.15m.</p> <ul style="list-style-type: none"> <li>• In specific situations where the drainage of bus lanes is not independent of drainage of MV lanes, a gap of up to 5cm may be provided between sets of two curbstones or after and interval of approximately 0.6m to prevent flooding of bus lanes.</li> <li>• The curbstones may be anchored to the pavement using dowel bar technique.</li> </ul> <p>Segregation between bus lanes:</p> <ul style="list-style-type: none"> <li>• Bus lanes should preferably be segregated from each other using a 0.75m wide band of diagonally (at 45 degree angle to the bus lane) oriented rumble strips, in concrete – curving in profile with a 125mm width and 25mm in height. The parallel gap between the rumble strips should be 0.6m.</li> <li>• For added safety to pedestrians who may take refuge in this buffer between bus lanes, bollards of varying designs may be used at a spacing of 18m along the length, and staggered at a distance of 150mm from each edge (clear distance), to allow buses to pass between them at very slow speed; in case of emergency or break down. The bollards should maintain a minimum clearance of 0.15m from the edge of the bus lane and should not be greater than 0.65m in height. Also it is preferable that such a system be discontinued at curves or bends in the road.</li> <li>• If space constraint along the cross section does not allow a 0.6m between the bus lanes, then the lanes should be segregated using a 0.15m high median of specifications used for median between MV lanes and bus lanes; however the minimum width of such segregation should not be less than 0.3m.</li> </ul>
7.	<b>Surface Quality</b>	Bus lane shall be constructed in plain concrete, laid in situ by pavers on existing road surface. Bus lane surface quality should provide comfortable riding conditions throughout its life. Special care should be taken while providing longitudinal and transverse joints in the pavement, ensuring the gaps between them are within acceptable comfort limits.
a.	Gaps	50 to 100mm wide expansion joints should be provided in the concrete pavement. These joints should be connected using Dowel Bars to allow horizontal movement of slabs (during expansion) while restricting vertical movement and allowing adequate load transfer <sup>4</sup> . Expansion joints should be sealed using an approved sealing material.
b.	Texture	Dedicated concrete bus lanes should have Drag Texture named “ <i>BROOMED SURFACE</i> ”. This texture shall be

<sup>4</sup> Illinois Department of Transportation, Bureau of Material and Physical Research, Design Construction and Materials, Pavement Technology Advisory, Concrete Pavement Joints

		obtained either by using a hand broom or by mechanical broom device that lightly drags the stiff bristles across the surface. The texture shall produce 1.5 – 3mm (1/16 – 1/8 in.) deep striations and shall be oriented transverse to centerline of concrete bus lane/roadway.
8.	<b>Slopes</b>	Bus lane slopes should be in accordance with the roadway design on bends. It should also comply with overall slope requirement of the roadway to drain surface water. The advisable cross slope for the bus lanes is 2%.



**Figure 4: Plan showing Parallel bus lanes and shelters at junction bus shelters**

## 2.2 Motor Vehicular (MV) Lanes

S.No.	Title	Specifications
1.	<b>Location</b>	Two or more continuous motor vehicular lanes should be provided on the left of bus lanes for each direction traffic
2.	<b>No. of Lanes</b>	<ul style="list-style-type: none"> <li>A minimum of two continuous MV lanes is proposed for the corridor.</li> <li>For up to 100m before the junction the MV lanes should be expanded by 0.5 to 2 lanes to 2.5 to 4 lanes, to increase the throughput of traffic at the junction.</li> <li>Wherever space permits, MV lanes may be widened by 0.5 to 1.0 lanes for a continuous stretch between junctions to allow for better throughput. However this should only be done after providing adequate space for all functions such NMV tracks, bus lanes, bus shelters, service lanes, parking, service parking etc. Also wherever space permits additional lanes should be added for up to 100m before the junction, to maximize throughput at the junction.</li> </ul>
3.	<b>Service Parking</b>	Service parking should be provided adjacent to MV lanes, at locations where demand for stopping of service

S.No.	Title	Specifications
		vehicles, cars and TSRs exists. The minimum length of heavy vehicle service parking bays should be 12m, and a depth of 2.5m. The minimum width of car and TSR stopping bay can be 1.5m. Such bays should not have a continuous length of more than 30m and should be segregated from the MV lanes using rough texture finish or rumble strips.
4.	<b>Size of lanes</b>	
A	Width	<ul style="list-style-type: none"> <li>• Each motor vehicular lane shall be 3.0m in width.</li> <li>• An additional 0.3m to 0.75m shy away distance may be provided on one or both edges of the motor vehicle carriageway</li> </ul>
b.	Length	Continuous – unless weaving with buses is required such as locations at the foot of flyover in which case physical segregation from bus lanes should be replaced with pavement markings
5.	<b>Edge Treatment</b>	<p>Segregation from Bus Lanes:</p> <ul style="list-style-type: none"> <li>• MV lanes may be segregated from bus lanes using curb stones of the following specifications:</li> <li>• The height of curb stones used should be necessarily less than 0.15m.</li> <li>• The edge facing bus lanes should be sloping so as to allow buses to exit the lane or to be pulled out in case of break down or other emergency.</li> <li>• The width of this edge/median should be preferably 0.6m (to serve as a refuge island for crossing pedestrians). The minimum width of this segregation for short stretches can be 0.15m.</li> <li>• In specific situations where the drainage of bus lanes is not independent of drainage of MV lanes, a gap of up to 5cm may be provided between sets of two curbstones or after and interval of approximately 0.6m to prevent flooding of bus lanes.</li> <li>• The curbstones may be anchored to the pavement using dowel bar technique.</li> </ul> <p>Segregation from cycle tracks:</p> <ul style="list-style-type: none"> <li>• Segregation between MV lanes and cycle tracks should be designed to allow the cyclists to leave the cycle path wherever necessary as per design.</li> <li>• On streets where fast moving MV traffic is expected (i.e. peak speeds of may exceed 50 km/h.) it is desirable to have a 0.6 to 0.75m wide segregation between MV lanes and the cycle track.</li> <li>• Such segregation may be created using curb stones with the maximum height of the edge facing MV lanes as 0.15m.</li> </ul>

S.No.	Title	Specifications
		<ul style="list-style-type: none"> <li>• Such segregation between MV lanes and cycle track may be used as buffer for providing services such as storm water collection chambers and light poles. The level of such a surface should be 10 to 25mm below the level of the carriageway, shielded from the carriageway by a single row of 0.15m thick curbstones (max height from road surface to be 0.15m).</li> <li>• In case of narrow road right of way the segregation between cycle track and MV lanes can be reduced to a 0.15m high (from MV lanes), 0.3m wide, median. The level of the cycle track may be raised so as the vertical edge from cycle track is only 75 to 50mm high.</li> <li>• In areas where extreme constriction of road right of way forces the cycle track to be combined with pedestrian path, the surface of cycle track and MV lane should be on and continuous segregated with a single row of bollards, maximum of 0.65m high, min. 0.15m wide and with a maximum clear gap between them as 1.25m. This arrangement though is not advisable for a continuous length of more than 40m.</li> </ul>
6.	<b>Surface Quality</b>	MV lanes shall be constructed in plain concrete, laid in situ by pavers on existing road surface. MV lane surface quality should provide comfortable riding conditions throughout its life. Special care should be taken while providing longitudinal and transverse joints in the pavement, ensuring the gaps between them are within acceptable comfort limits.
a.	Gaps	50 to 100mm wide expansion joints should be provided in the concrete pavement. These joints should be connected using Dowel Bars to allow horizontal movement of slabs (during expansion) while restricting vertical movement and allowing adequate load transfer <sup>5</sup> . Expansion joints should be sealed using an approved sealing material.
b.	Texture	Concrete MV lanes should have Drag Texture named " <i>BROOMED SURFACE</i> ". This texture shall be obtained either by using a hand broom or by mechanical broom device that lightly drags the stiff bristles across the surface. The texture shall produce 1.5 – 3mm (1/16 – 1/8 in.) deep striations and shall be oriented transverse to centerline of concrete bus lane/roadway.
7	<b>Slopes</b>	MV lane slopes should be in accordance with the roadway design on bends. It should also comply with overall slope requirement of the roadway to drain surface water. The advisable cross slope for the bus lanes is 2%.

<sup>5</sup> Illinois Department of Transportation, Bureau of Material and Physical Research, Design Construction and Materials, Pavement Technology Advisory, Concrete Pavement Joints

## 2.3 Non Motorized Vehicular (NMV) Lanes

S.No.	Title	Specifications
1.	<b>Location</b>	A single path for non motorized vehicles such as cycles and cycle rickshaws should be provided between motor vehicle lanes and the pedestrian path for each direction of traffic on both sides of the road and be should preferably be 50 to 100mm above the carriageway level.
2.	<b>Entry/Exit</b>	<ul style="list-style-type: none"> <li>• NMV lanes need to be punctured at the junctions and at entrance to properties/ side lane or access to service lane to allow access by cyclists and cycle rickshaws.</li> <li>• Bollards should be used at all entry and exit points to cycle track with 1.25m to 1.3m as the clear distance between them as 1.25 m and a maximum height of 0.65m, to prevent encroachment by motor vehicles and TSRs.</li> <li>• At all entrance/exit points to NMV tracks other than those at signalized intersections, the entrance exit area should be raised to a level of 0.15m above the carriageway, and accessed by a ramp with a maximum slope of 1:10 from all sides.</li> <li>• At junctions (on the after side of the junction), the segregation between NMV and MV lane should be setback by a minimum of 30m. Independent bollards or curbstones spaced at an interval of 1.5 to 2.0m should be used to define the cycle path for this length. This would give the cyclists (released in groups after each red light) the flexibility to enter the NMV lane along the edge, if the entrance is congested by slow moving rickshaw traffic.</li> </ul>
3.	<b>Parking</b>	<p>High parking demand exists for cycle rickshaws, which ply on main roads and serve as feeder service to public transport. The specifications for providing cycle rickshaw parking along BRT corridor shall be as following:</p> <ul style="list-style-type: none"> <li>• Cycle rickshaw parking should be provided adjacent to cycle tracks (at the same level) as 1.5m to 2.5m deep bays (for parallel or perpendicular parking), near pedestrian crossings, bus shelters, important nodes, and landmarks attracting heavy pedestrian traffic; or wherever existing demand is observed.</li> <li>• Cycle rickshaw parking should be close to pedestrian crossings at intersections preferably on the 'on side' of the junction.</li> <li>• The capacity of cycle rickshaw parking should be as</li> </ul>



S.No.	Title	Specifications
		<p>per existing demand at that location.</p> <ul style="list-style-type: none"> <li>• Cycle rickshaw parking should include, features such as sign boards, light poles, stands, rails (for locking bicycles) etc.</li> </ul>
4.	<b>Size of lanes</b>	
A	Width	<ul style="list-style-type: none"> <li>• Clear width of NMV lanes should preferably be 2.5m.</li> <li>• Where road right of way is constrained, the NMV lane width can be reduced to 1.8m</li> <li>• In case of severe constriction of right of way, NMV lane width can be reduced to 1.5m but this width should not be consistent over large lengths of the lane.</li> <li>• At locations where right of way widths do not permit segregated bicycle tracks, bicycle track may be combine with pedestrian path (with a total minimum width of 2.0m) for short stretches. The level of this stretch (10 to 40m long) should be the same as carriageway and should be segregated from MV lanes using a row of bollards with a clear gap of between 1.25 to 1.3m.</li> <li>• At constrained right of way locations where the combined minimum width of NMV lanes and pedestrian paths can be between 2.5 and 3.5m, and the total length of the constrained stretch is not more than 10m, the bicycle path may be raised using ramps with min. gradient of 1:10 to the level of the footpath for combining the two at both ends of the constrained stretch.</li> </ul>
b.	Length	<p>Continuous segregated – unless at stretches where sever constriction of right of way rules out the possibility of segregated tracks. At such locations visual continuity of cycle tracks should be maintained using texture and pavement markings.</p>
5.	<b>Edge Treatment</b>	<p>Segregation from Pedestrian Paths:</p> <ul style="list-style-type: none"> <li>• NMV lanes should be visually and physically segregated from pedestrian paths to make a clear distinction between the areas to be used by each user.</li> <li>• Pedestrian paths should be preferably raised from the NMV lanes by 25 to 75mm. The edge could be maintained by curbstones which remain flushed with pedestrian path paving.</li> <li>• NMV lanes can be combined with pedestrian paths at locations where the right of way is less than 28 to (at stretches with bus shelter) 25m (at stretches without bus shelter). Such stretches should preferably not be longer than 40m. At such locations no visual or physical edge need to be defined between pedestrian paths and</li> </ul>

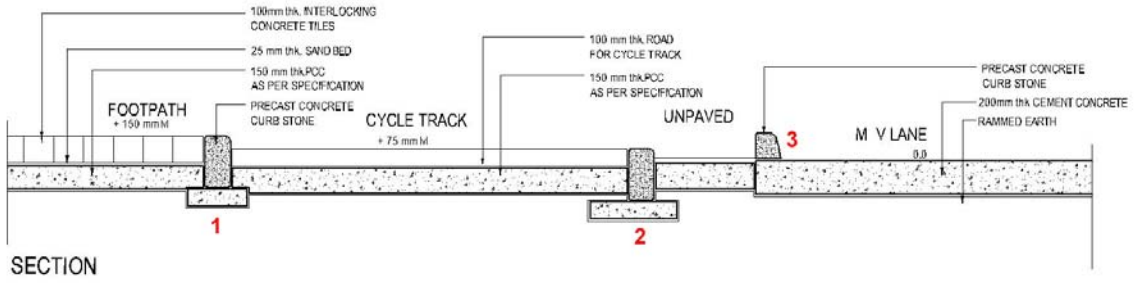
S.No.	Title	Specifications
		<p>NMV lanes.</p> <ul style="list-style-type: none"> <li>• At locations where providing service lane is advisable and limitations of right of way lead to combining of service lane, parking and pedestrian facilities such as the level of service lane is raised to 0.15m above the carriageway level and approx. 25 to 75mm above the NMV lane level; the bicycle track should be segregated from the service lane using bollards, benches, planters etc., with a clear gaps of between 0.45m to 0.65m and a maximum permissible height of 0.65m.</li> </ul> <p>Segregation from MV lanes:</p> <ul style="list-style-type: none"> <li>• Segregation between MV lanes and cycle tracks should be designed to allow the cyclists to leave the cycle path at any time with little or no difficulty.</li> <li>• On streets where fast moving MV traffic is expected (i.e. peak speeds of more than 50 km/hr) it is desirable to have a 0.6 to 0.75m wide segregation between MV lanes and the cycle track.</li> <li>• Such segregation may be created using curb stones with the maximum height of the edge facing MV lanes as 0.15m.</li> <li>• Such segregation between MV lanes and cycle track may be used as buffer for providing services such as storm water collection chambers and light poles. The level of such a surface should be 10 to 25mm below the level of the carriageway, shielded from the carriageway by a single row of 0.15m thick curbstones (max height from road surface to be 0.15m).</li> <li>• In case of narrow road right of way the segregation between cycle track and MV lanes can be reduced to a 0.15m high (from MV lanes), 0.3m wide, median. The level of the cycle track may be raised so as the vertical edge from cycle track is only 75 to 50mm high.</li> <li>• In areas where extreme constriction of road right of way forces the cycle track to be combined with pedestrian path, the surface of cycle track and MV lane should be on and continuous segregated with a single row of bollards, maximum of 0.65m high, min. 0.15m wide and with a maximum clear gap between them as 1.25m. This arrangement though is not advisable for a continuous length of more than 40m, and should only be considered where right of way is less than 28 to (at stretches with bus shelter) 25m (at stretches without bus shelter).</li> </ul>
6.	<b>Surface Quality</b>	The surface of bicycle path should be in 100mm thick cement concrete with 150mm thick PCC base.

S.No.	Title	Specifications									
a.	Gaps and Joints	<p data-bbox="586 218 1370 867"> <b>Joints and Utility Work<sup>6</sup></b>            The quality of a bikeway's riding surface is important. Pavement surface irregularities can do more than cause an unpleasant ride. Gaps between pavement slabs or drop-offs at overlays or patches parallel to the direction of travel can trap a bicycle wheel and cause loss of control. Holes and bumps can cause bicyclists to swerve into the path of motor vehicles. A single surface irregularity in itself may not cause as much discomfort as a group of or continuous irregularities. Bicycle pavements should be at least as smooth as the adjacent road or bicyclists may not use them. The two types of hazards which are classified as surface irregularities are cracks and projections. Cracks are generally normal fissures such as the gap between two slabs of pavement. Projections may be caused by sinking drainage grates or crude patch jobs. They are further classified as having a parallel or perpendicular orientation. Table 8 shows maximum acceptable surface irregularities on bikeways.         </p> <p data-bbox="586 873 1370 936"> <b>Table 8: Maximum acceptable surface irregularities on bikeways</b> </p> <table border="1" data-bbox="591 951 1370 1094"> <thead> <tr> <th data-bbox="591 951 867 1024">Orientation of Irregularities</th> <th data-bbox="872 951 1101 1024">Cracks<sup>1</sup></th> <th data-bbox="1105 951 1370 1024">Projections<sup>2</sup></th> </tr> </thead> <tbody> <tr> <td data-bbox="591 1024 867 1056">Parallel</td> <td data-bbox="872 1024 1101 1056">13mm wide</td> <td data-bbox="1105 1024 1370 1056">10mm high</td> </tr> <tr> <td data-bbox="591 1056 867 1094">Perpendicular</td> <td data-bbox="872 1056 1101 1094">13 mm wide</td> <td data-bbox="1105 1056 1370 1094">20mm high</td> </tr> </tbody> </table> <p data-bbox="586 1129 1370 1230">           1) Cracks/Fissures in the surface. Often found in hot mix asphalt surfaces or between slabs of Portland cement concrete.         </p> <p data-bbox="586 1236 1370 1404">           2) Projections: abrupt rises in the surface of the traveled way. May be caused by sinking drainage grates, crude patching of the surface, partial erosion of a layer of asphalt, pavement joints, pedestrian ramp transitions, or root growth under pavement.         </p> <p data-bbox="586 1440 1370 1541">           To ensure that the riding surface is maintained at a level which is smooth enough for bicyclists safety and comfort, the following guidelines should be followed:         </p> <ol data-bbox="634 1577 1370 1808" style="list-style-type: none"> <li data-bbox="634 1577 1370 1713">1. Locate public utility installations such as manhole covers, drainage grates and gate chambers so that they remain outside of paths Inspect control joints on paths.</li> <li data-bbox="634 1719 1370 1808">2. Schedule regular maintenance to remove sand (including early removal of sand left by winter sanding operations), earth, and other matter that</li> </ol>	Orientation of Irregularities	Cracks <sup>1</sup>	Projections <sup>2</sup>	Parallel	13mm wide	10mm high	Perpendicular	13 mm wide	20mm high
Orientation of Irregularities	Cracks <sup>1</sup>	Projections <sup>2</sup>									
Parallel	13mm wide	10mm high									
Perpendicular	13 mm wide	20mm high									

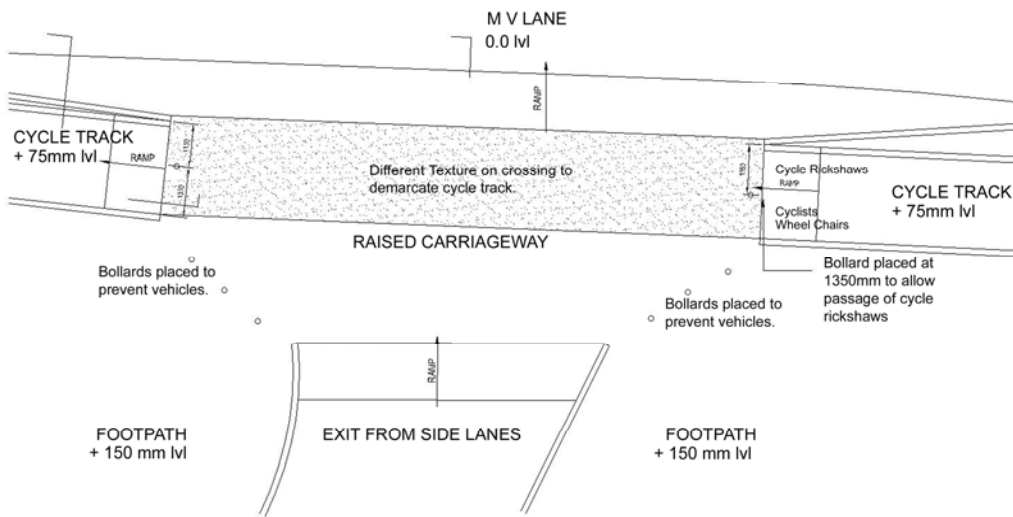
<sup>6</sup> Minnesota Bicycle Transport Planning and Design Guidelines, Minnesota Department of Transportation, June 1996

S.No.	Title	Specifications														
		<p>may cause skidding.</p> <p>3. Eliminate surface irregularities which may make riding uncomfortably bumpy or lead to drainage problems or cause bicyclists to use the roadway instead of a path.</p> <p>4. Ensure that drainage grates, if located on or near a path, have narrow openings and be placed perpendicular to the riding surface.</p>														
b.	Texture	NMV track surface should be provided texture to allow for sufficient skid resistance. The texture should preferably be parallel to cross slope for drainage and perpendicular to bicycle movement, to prevent ponding on the track.														
7.	<b>Slopes</b>	<p>Cross Slopes for drainage: The recommended minimum pavement cross slope of 2 percent adequately provides for drainage. <i>Sloping in the direction of curb drain and gutters should be ensured.</i> Smooth surface is essential to prevent water ponding. Where necessary, catch basins with drains should be provided to carry the intercepted water under the path. Drainage grates and manhole covers should be located outside of the travel path of users. To assist in draining the area adjacent to the NMV track, the design should include considerations for preserving the natural ground cover (Figure 6).</p> <p>Permissible Longitudinal Grade and Length</p> <p><b>Table 9: Maximum grade lengths for bicycle paths with grades in excess of 5%<sup>7</sup></b></p> <table border="1" data-bbox="581 1234 1383 1480"> <thead> <tr> <th data-bbox="581 1234 987 1264">Longitudinal Grade</th> <th data-bbox="993 1234 1383 1264">Length</th> </tr> </thead> <tbody> <tr> <td data-bbox="581 1272 987 1302">5%-6%</td> <td data-bbox="993 1272 1383 1302">240m</td> </tr> <tr> <td data-bbox="581 1310 987 1339">7%</td> <td data-bbox="993 1310 1383 1339">120m</td> </tr> <tr> <td data-bbox="581 1348 987 1377">8%</td> <td data-bbox="993 1348 1383 1377">90m</td> </tr> <tr> <td data-bbox="581 1386 987 1415">9%</td> <td data-bbox="993 1386 1383 1415">60m</td> </tr> <tr> <td data-bbox="581 1423 987 1453">10%</td> <td data-bbox="993 1423 1383 1453">30m</td> </tr> <tr> <td data-bbox="581 1461 987 1491">11+%</td> <td data-bbox="993 1461 1383 1491">15m</td> </tr> </tbody> </table>	Longitudinal Grade	Length	5%-6%	240m	7%	120m	8%	90m	9%	60m	10%	30m	11+%	15m
Longitudinal Grade	Length															
5%-6%	240m															
7%	120m															
8%	90m															
9%	60m															
10%	30m															
11+%	15m															

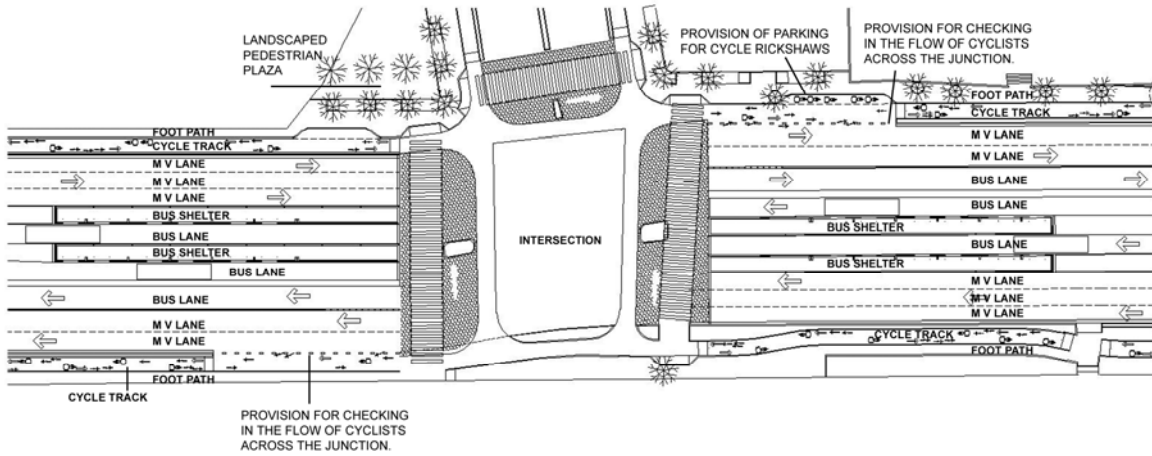
<sup>7</sup> <http://www.dot.state.il.us/blr/manuals/Chapter%2042.pdf>



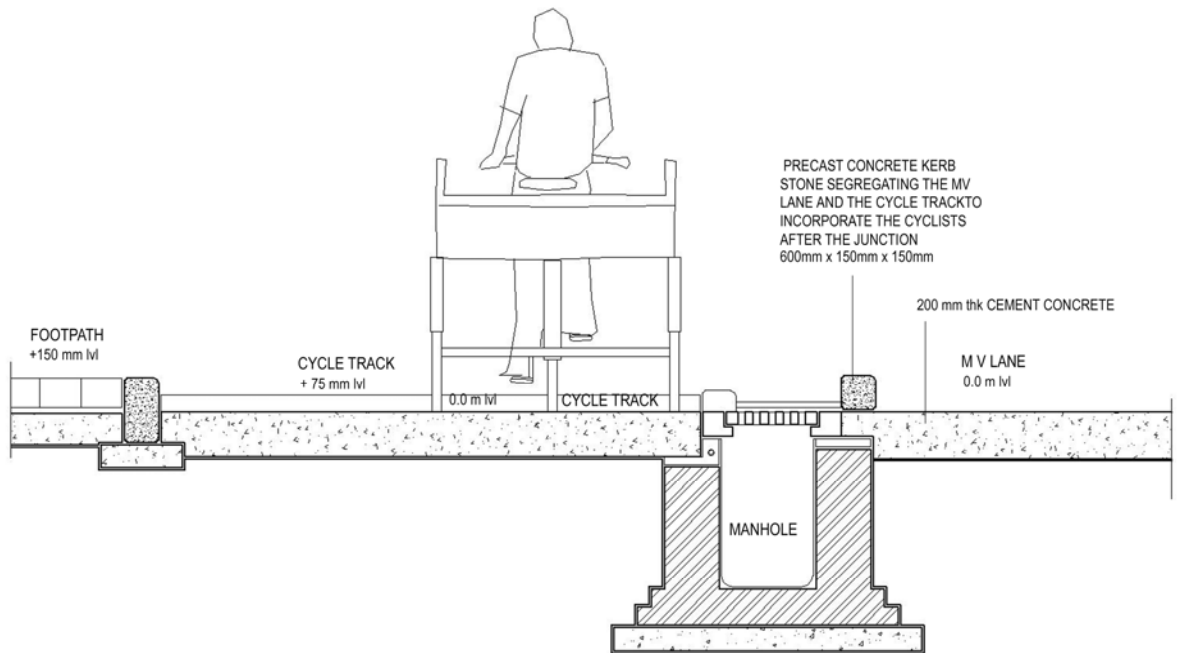
**Figure 5: Detail section showing segregation between cycle track and MV lanes**



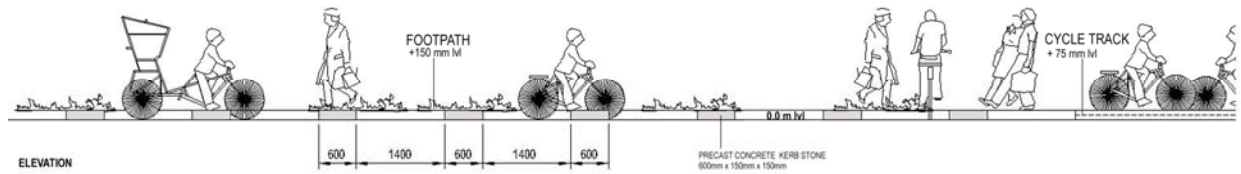
**Figure 6: Detail plan for entry exit to service and side lanes**



**Figure 7: Plan showing entry exit to cycle track at junctions**



**Figure 8: Detail cross section of cycle track entry at (on the off side of) junction.**



**Figure 9: Detail elevation of cycle track entry at (on the off side of) junction.**

## 2.4 Pedestrian Paths

S.No.	Title	Specifications										
1.	<b>Location</b>	Pedestrian paths should be located between the NMV track and the service lane or building boundary, on both sides of the carriageway. The elevation of pedestrian path from the MV lane should not be more than 0.15m										
2.	<b>Entry/Exit</b>	All pedestrian infrastructures should be barrier free for all. It should be paved using adequate tactile pavers for blind, with warning blocks laid carefully at all entrance/ exits (openings to side lanes, parking and pedestrian crossings) to the pedestrian facilities. All entry exit points should be accessible by wheelchair with a maximum slope of 1:12.										
3.	<b>Size of lanes</b>											
a.	<b>Width</b>	<ul style="list-style-type: none"> <li>The minimum clear width of the pedestrian path should be 1.5m. However the width of pedestrian paths is dependent on pedestrian volumes at a particular location. The following table should be used to provide adequate width of pedestrian path<sup>8</sup>:</li> </ul> <p><b>Table 10: Effective capacity for width of pedestrian paths.</b></p> <table border="1"> <thead> <tr> <th>Effective width of footpath (m)</th> <th>Effective capacity as per LOS C in persons per/min counted (averaged) over 15min</th> </tr> </thead> <tbody> <tr> <td>1.5</td> <td>23-50</td> </tr> <tr> <td>2.5</td> <td>58-83</td> </tr> <tr> <td>3.5</td> <td>81-116</td> </tr> <tr> <td>5.0</td> <td>115-165</td> </tr> </tbody> </table> <ul style="list-style-type: none"> <li>Where road right of way is constrained, pedestrian paths can be combined with service lane/parking, provided the service lane and is textured in pavers indicating pedestrian use and right of way and it is at the same level as pedestrian infrastructure to maintain a continuity of the pedestrian path. The speeds of vehicles on all such mixed lanes should be controlled by the use adequate texture and traffic calming devices.</li> <li>At locations where right of way widths do not permit segregated bicycle tracks, bicycle track may be combine with pedestrian path (with a total minimum width of 2.0m) for short stretches. The level of this stretch (10 to 40m long) should be the same as carriageway and should be segregated from MV lanes using a row of bollards with a clear gap of between 1.25 to 1.3m.</li> </ul>	Effective width of footpath (m)	Effective capacity as per LOS C in persons per/min counted (averaged) over 15min	1.5	23-50	2.5	58-83	3.5	81-116	5.0	115-165
Effective width of footpath (m)	Effective capacity as per LOS C in persons per/min counted (averaged) over 15min											
1.5	23-50											
2.5	58-83											
3.5	81-116											
5.0	115-165											

<sup>8</sup> Calculated from Transportation Research Board, US, Highway Capacity manual, 2000, Chapter 11, Pedestrians and Bicycle Concepts, Page 11-9

S.No.	Title	Specifications																														
		<ul style="list-style-type: none"> <li>At constrained right of way locations where the combined minimum width of NMV lanes and pedestrian paths can be between 2.5 and 3.5m, and the total length of the constrained stretch is not more than 10m, the bicycle path may be raised using ramps with min. gradient of 1:10 to the level of the footpath for combining the two at both ends of the constrained stretch.</li> </ul>																														
b.	Length	<ul style="list-style-type: none"> <li>Continuous segregated – unless at stretches where severe constriction of right of way rules out the possibility of segregated tracks. At such locations visual continuity of cycle tracks should be maintained using texture and pavement markings.</li> <li>Pedestrian paths should be shaded and space for service providers (hawkers), benches, street light and poles etc, should be provided outside the pedestrian path, the edge for which should be clearly defined.</li> <li>Benches for disabled should be provided along the pedestrian path for use by disabled and general public alike. The spacing of such facilities should be between 180 to 360 m., based on the table shown below.</li> </ul> <p><b>Table 11: Cumulative percentage of mobility impaired people observed to be unable to move more than the stated distance in city centres without rest<sup>9</sup>.</b></p> <table border="1" data-bbox="570 1066 1383 1388"> <thead> <tr> <th></th> <th>18m</th> <th>68m</th> <th>137m</th> <th>180m</th> <th>360m</th> </tr> </thead> <tbody> <tr> <td>Wheelchair Users</td> <td>0</td> <td>5</td> <td>5</td> <td>60</td> <td>85</td> </tr> <tr> <td>Visually Impaired</td> <td>0</td> <td>0</td> <td>5</td> <td>50</td> <td>75</td> </tr> <tr> <td>Ambulant Disabled with walking aid</td> <td>10</td> <td>25</td> <td>40</td> <td>80</td> <td>95</td> </tr> <tr> <td>Ambulant Disabled without walking aid</td> <td>5</td> <td>15</td> <td>25</td> <td>70</td> <td>80</td> </tr> </tbody> </table>		18m	68m	137m	180m	360m	Wheelchair Users	0	5	5	60	85	Visually Impaired	0	0	5	50	75	Ambulant Disabled with walking aid	10	25	40	80	95	Ambulant Disabled without walking aid	5	15	25	70	80
	18m	68m	137m	180m	360m																											
Wheelchair Users	0	5	5	60	85																											
Visually Impaired	0	0	5	50	75																											
Ambulant Disabled with walking aid	10	25	40	80	95																											
Ambulant Disabled without walking aid	5	15	25	70	80																											
4.	<b>Edge Treatment</b>	<p>Segregation from NMV Paths:</p> <ul style="list-style-type: none"> <li>NMV lanes should be visually and physically segregated from pedestrian paths to make a clear distinction between the areas to be used by each user.</li> <li>Pedestrian paths should be preferably raised from the NMV lanes by 25 to 75mm. The edge could be maintained by curbstones which remain flushed with pedestrian path paving.</li> <li>NMV lanes can be combined with pedestrian paths at locations where the right of way is less than 28 to (at stretches with bus shelter) 25m (at stretches without</li> </ul>																														

<sup>9</sup> Cheshire County Council, Pedestrian Access and Mobility – A code of Practice, Second Edition, Table 1, January 2005



S.No.	Title	Specifications								
		<p>bus shelter). Such stretches should preferably not be longer than 40m. At such locations no visual or physical edge need to be defined between pedestrian paths and NMV lanes.</p> <ul style="list-style-type: none"> <li>At locations where providing service lane is advisable and limitations of right of way lead to combining of service lane, parking and pedestrian facilities such as the level of service lane is raised to 0.15m above the carriageway level and approx. 25 to 75mm above the NMV lane level; the bicycle track should be segregated from the service lane using bollards, benches, planters etc., with a clear gaps of between 0.45m to 0.65m and a maximum permissible height of 0.65m.</li> </ul> <p>Segregation from Service/parking lanes:</p> <ul style="list-style-type: none"> <li>Pedestrian paths should be on both sides of the service lane and they should be 0.10 to 0.15m above the level of the service lane.</li> <li>At locations where it is not possible to provide a total of 2.4m wide pedestrian path on both sides of service lane (with a minimum width of pedestrian path between service lane and NMV track as 1.5m), pedestrian path should be combined with the service lane (as mentioned above), with entrance exit to properties, side lanes, MV lanes and the edge with NMV lane; protected against parking by bollards spaced at an interval of 0.45 to 0.65m.</li> </ul>								
5.	<b>Surface Quality</b>	Pavement pattern, texture and colour of pedestrian paths should be used to define a clear pedestrian right of way and to emphasize its directness and continuity. The walking surface should be as free from surface irregularities to prevent tripping against raised edges.								
6.	<b>Slopes</b>	<p>Cross Slopes for drainage: The recommended minimum pavement cross slope of 2 percent adequately provides for drainage. <i>Sloping in the direction of curb drain and gutters should be ensured.</i> Smooth surface is essential to prevent water ponding.</p> <p><b>Table 12: Permissible Longitudinal Grade and Length for pedestrian path and wheel chair ramps (a landing minimum 1.5m long is recommended after this length)<sup>10</sup>.</b></p> <table border="1" data-bbox="574 1633 1383 1789"> <thead> <tr> <th data-bbox="574 1633 954 1667">Length of Ramp (in metres)</th> <th data-bbox="959 1633 1383 1667">Maximum Gradient</th> </tr> </thead> <tbody> <tr> <td data-bbox="574 1673 954 1707">2</td> <td data-bbox="959 1673 1383 1707">1:12</td> </tr> <tr> <td data-bbox="574 1713 954 1747">5</td> <td data-bbox="959 1713 1383 1747">1:15</td> </tr> <tr> <td data-bbox="574 1753 954 1789">10</td> <td data-bbox="959 1753 1383 1789">1:20</td> </tr> </tbody> </table>	Length of Ramp (in metres)	Maximum Gradient	2	1:12	5	1:15	10	1:20
Length of Ramp (in metres)	Maximum Gradient									
2	1:12									
5	1:15									
10	1:20									

<sup>10</sup> Cheshire County Council, Pedestrian Access and Mobility – A code of Practice, Second Edition, Table 2, January 2005



**Figure 10: Raised platform treatment for pedestrian paths across entrance/exit to side lanes and service lanes in Bogota, Columbia**

## 2.5 Service Lane and Parking

S.No.	Title	Specifications
1.	<b>Location</b>	Service lanes should be provided (wherever space permits) in front of property boundaries (providing footpath on both sides). Service lanes help rationalize cycle track punctures to provide entry exit to side lanes and properties.
2.	<b>Entry/Exit</b>	<ul style="list-style-type: none"> <li>• Service lanes are provided to reduce punctures in cycle tracks and to reduce number of conflict points where traffic from inner lanes and properties merge with the MV lanes. Therefore entry exits to service lanes should be as less in number as possible. The spacing between these openings should preferably be between 100 to 500m.</li> <li>• Raised platform treatment should be provided at the entrance/exit of service lanes. This helps reduce speed of conflicting vehicles. The entry exit should be raised at the level of pedestrian footpath, with lines defining cycle path across it created in flushed concrete blocks. The texture provided should clearly indicate the pedestrian right of way.</li> </ul>
3.	<b>Size</b>	

S.No.	Title	Specifications
a.	Width	<ul style="list-style-type: none"> <li>• Service lanes should have a minimum width of 3.5m. Such lanes should necessarily have one way sign posting.</li> <li>• Service lanes with parking on both or one side can be 3.0 to 6.0m wide (depending on the angle of parking, from 0-parallel to 90 degree).</li> <li>• Width required for each type of car parking facility is extra and should be added to the respective width of the service lane.</li> <li>• Service lanes more than 4.5m in width can be used for two way traffic movement.</li> </ul>
b.	Length	<ul style="list-style-type: none"> <li>• The maximum continuous length of the service lane can be equivalent to the length between two signalized junctions on the carriageway alongside.</li> <li>• Service lanes should terminate before each signalized intersection.</li> <li>• Service lanes should not open into side lanes at junctions and should be segregated by either raised pedestrian infrastructure, space for hawkers (raised by 0.15m from the level of service lane) or bollards (in case of common service lane and footpath).</li> <li>• Parking may be provided along the length of the service lane, however care should be taken and infrastructure designed to discourage obstructive parking in front of property and side lane accesses.</li> </ul>
4.	<b>Edge Treatment</b>	<p>Segregation from Parking:</p> <ul style="list-style-type: none"> <li>• Parking shall be at the same level as the service lane.</li> <li>• Parking can be segregated from the service lane, visually by providing a different texture which may be rougher than the one used for service lane. Demarcation for each car parking space may also be done using a variety of textures.</li> <li>• Service lane can be defined from the parking area using bollards or planters, spaced at an interval of 10 to 20m, with parking defined with these obstructions.</li> </ul> <p>Segregation from pedestrian paths:</p> <ul style="list-style-type: none"> <li>• Pedestrian paths should be on both sides of the service lane and they should be 0.10 to 0.15m above the level of the service lane.</li> <li>• At locations where it is not possible to provide a total of 2.4m wide pedestrian path on both sides of service lane (with a minimum width of pedestrian path between service lane and NMV track as 1.5m), pedestrian path should be combined with the service lane (as mentioned above), with entrance exit to properties, side lanes, MV lanes and the edge with NMV lane; protected against parking by bollards spaced at an</li> </ul>

S.No.	Title	Specifications
		interval of 0.45 to 0.65m.
5.	<b>Surface Quality</b>	<ul style="list-style-type: none"> <li>• Service lanes should be designed for maximum speeds of 20 to 30 km/h. Traffic calming measures and surface texture can be used to enforce the adequate speed limits.</li> <li>• A variety of surfacing material can be used to pave service lanes, these vary from asphalt, to concrete to block pavers such as interlocking cement tiles (for vehicular use) and rough stone pavers when combined with pedestrians.</li> <li>• Wherever service lanes are combined with pedestrian facility; pavement pattern, texture and colour should be used to define a clear pedestrian right of way and to emphasize its directness and continuity. The walking surface should be as free from surface irregularities to prevent tripping against raised edges. Wherever service lane also serves as pedestrian path, the surface treatment should reduce vehicular speeds.</li> </ul>
6.	<b>Slopes</b>	<ul style="list-style-type: none"> <li>• The recommended minimum pavement cross slope of 2 percent adequately provides for drainage. <i>Sloping in the direction of curb drain and gutters should be ensured.</i> Smooth surface is essential to prevent water ponding.</li> <li>• A recommended ramp with a gradient of 1:10 should be provided to access all raised platforms at the entrance/exit to service lanes. The ramp texture should be resistant to skid and wear.</li> </ul>

## 2.6 Hawkers and Vendors

All Indian cities have street vendors operating on all major roads and they serve as important service providers for road users. A note issued by the Prime Ministers office also recognizes this and suggests that pavement vendors prevent street crime. Principles used to ensure that street vendors do not obstruct traffic are outlined below.

S.No.	Title	Specifications
1.	<b>Location</b>	<ul style="list-style-type: none"> <li>• Hawkers can be categorized into three: serving the pedestrians, serving the cyclists and serving the scootrists &amp; the TSR / Auto rickshaws.</li> <li>• A location, which is ideal and proposes a promising business as per the user should be assigned. Preferably at nodes where there is a lot of moving human traffic and complements the other side-activities which support the bus shelters. Also near important institutions and places of worship.</li> <li>• Another criteria is shelter i.e. at places where there is a lot of shade or could be given by planting more trees/</li> </ul>

S.No.	Title	Specifications
		planters.
2.	<b>Entry/Exit</b>	<ul style="list-style-type: none"> <li>It should be at the same level as that of the pedestrian path</li> </ul>
3.	<b>Size</b>	<ul style="list-style-type: none"> <li>The space requirement should be on the basis of the existing land use and the new usage pattern should not be very different from the old usage.</li> </ul>
a.	Width	<ul style="list-style-type: none"> <li>The minimum width required per hawker is 2m. The minimum area required for a hawker to sell and do business is 4m<sup>2</sup>.</li> </ul>
b.	Length	<ul style="list-style-type: none"> <li>The length has to be decided by the number of hawkers from the land use survey.</li> </ul>
4.	<b>Edge Treatment</b>	<p>Segregation from Footpath:</p> <ul style="list-style-type: none"> <li>It is at the same level as that of the pedestrian path.</li> <li>It can be segregated from the pedestrian path, visually by providing bollards spaced at a clear distance of 1.25m – 1.3m and providing different texture/ flooring pattern, which demarcates the space from main pedestrian path.</li> <li>These line of bollards also prevent the three-wheelers from using the space for parking.</li> <li>The design of the bollard is at the discretion of the designer which makes this space more attractive.</li> </ul> <p>Segregation from Cycle Track:</p> <ul style="list-style-type: none"> <li>It is at the same level as that of the cycle track and is located on the unpaved belt which segregates the M V lane and cycle track.</li> <li>It can be defined using bollards spaced at a clear distance of 1.25m – 1.3m and providing a different texture / flooring pattern which demarcates the space. The bollards should be placed at an offset of 0.3m from the edge of the cycle track.</li> <li>The design of the bollard is at the discretion of the designer which makes this space more attractive.</li> </ul> <p>Segregation from M V lane</p> <ul style="list-style-type: none"> <li>The edge is 0.15m higher from the M V lane and is 0.3m – 0.45m wide, desired as a step to prevent tripping. The rest of the space is at 0.75m from the M V lane.</li> </ul>

S.No.	Title	Specifications
5.	<b>Surface Quality</b>	<ul style="list-style-type: none"> <li>• A variety of surfacing material can be used to pave these spaces, these vary from interlocking tiles to rough stone pavers, thus defining a clear space which would be more usable and without much hindrance.</li> </ul>
6.	<b>Other features</b>	<ul style="list-style-type: none"> <li>• Apart from its surface texture and pattern, this urban space has to be detailed out with street furniture like a sitting area/bench, signage, dustbins, lightning, and drain point. A detailed study of the various hawkers and their requirement should be done in order to minimize waste of space and increase the efficiency should carefully place the street furniture.</li> <li>• The entire space should be cool and attractive. It should be vandalism proof and requires low maintenance.</li> </ul>

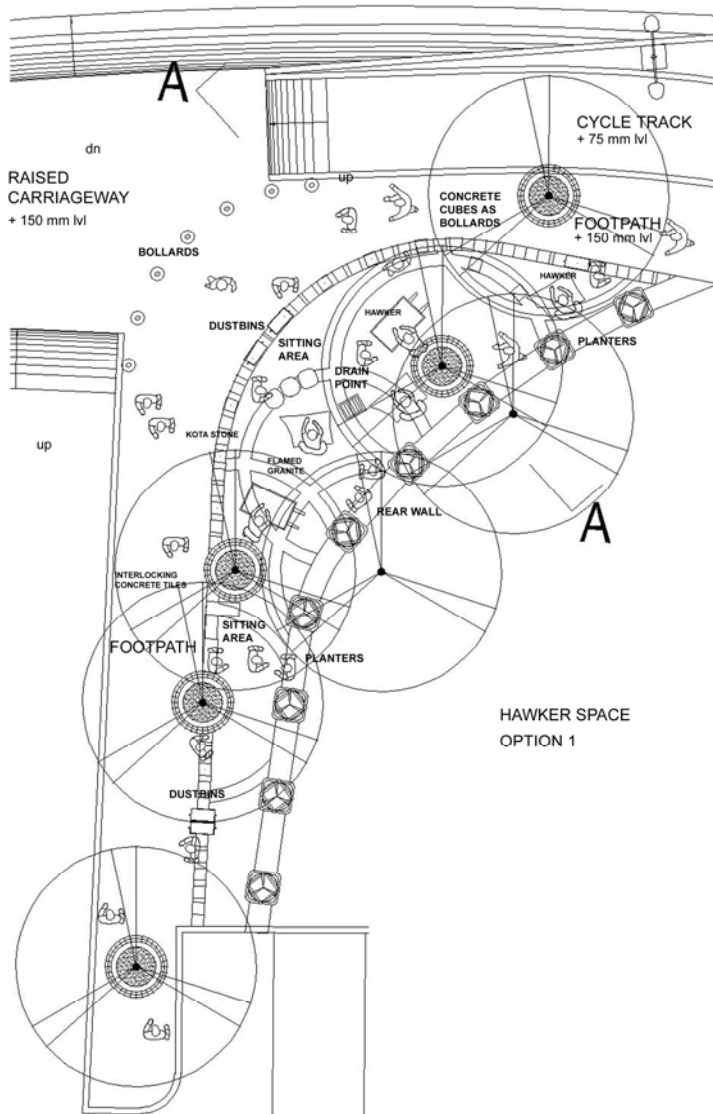


Figure 11: Detail plan of hawker space showing edge treatment and floor finishes (option1)

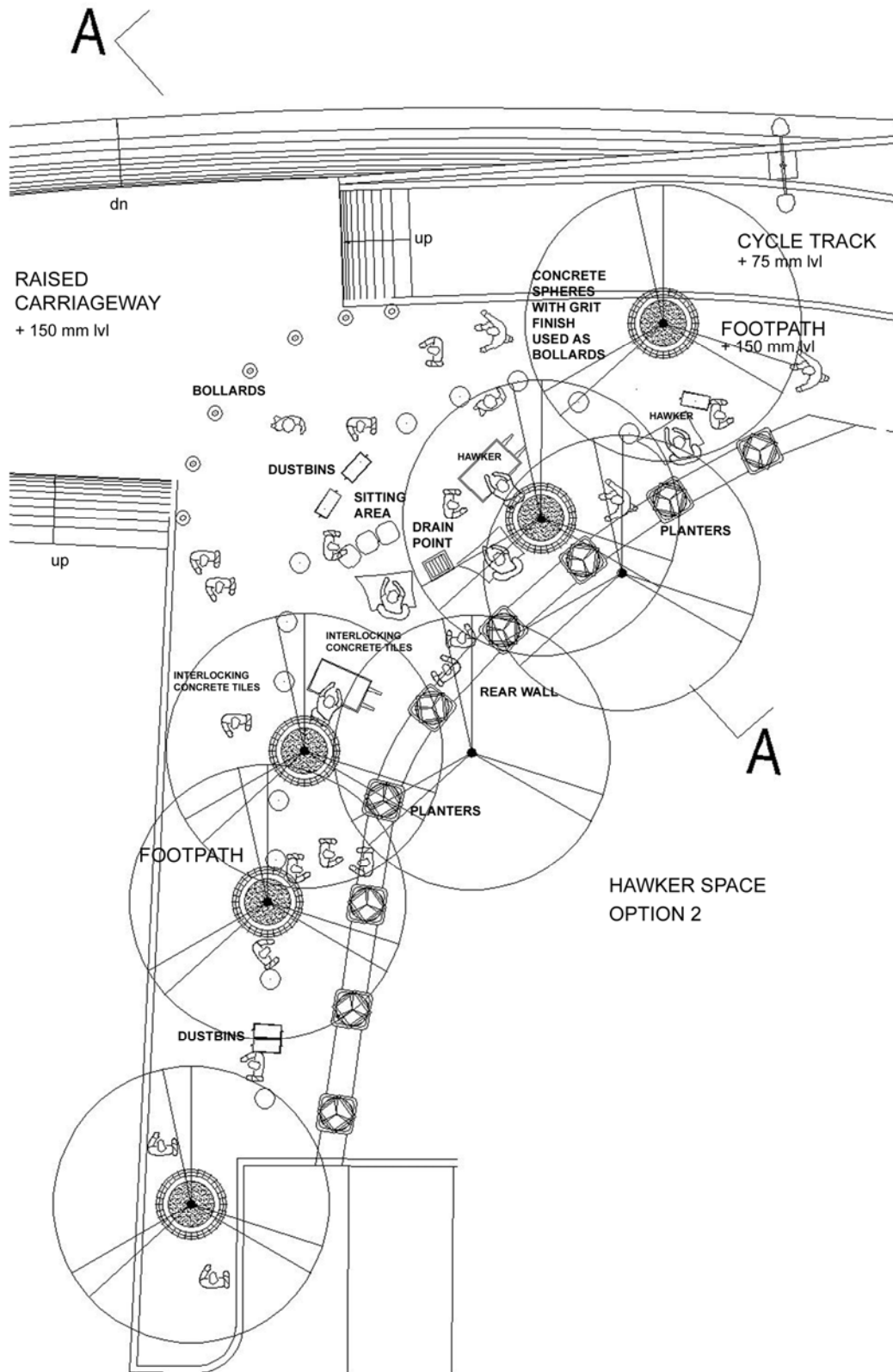


Figure 12: Detail plan of hawker space showing edge treatment and floor finishes (option2)



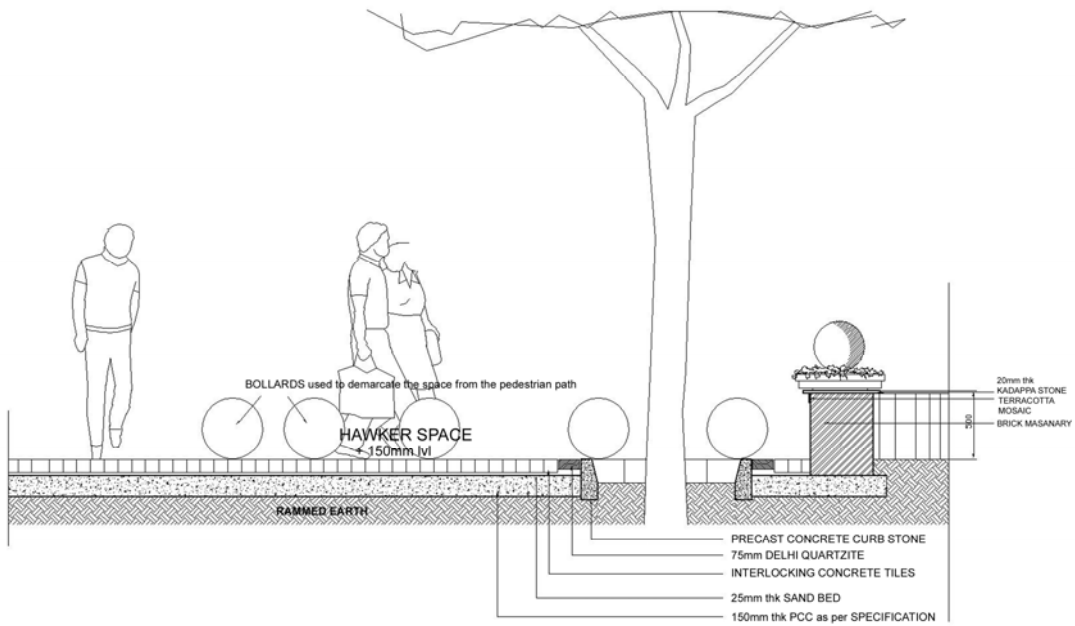


Figure 13: Detail section through hawker space

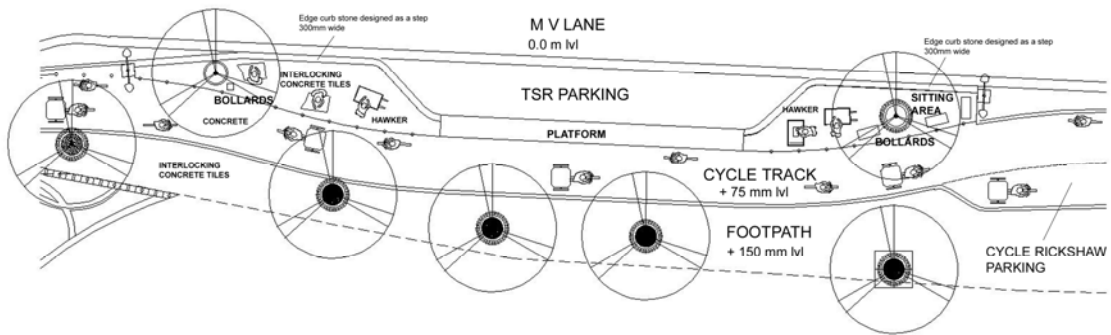


Figure 14: Plan showing design of hawker spaces adjacent to MV lanes and Cycle track

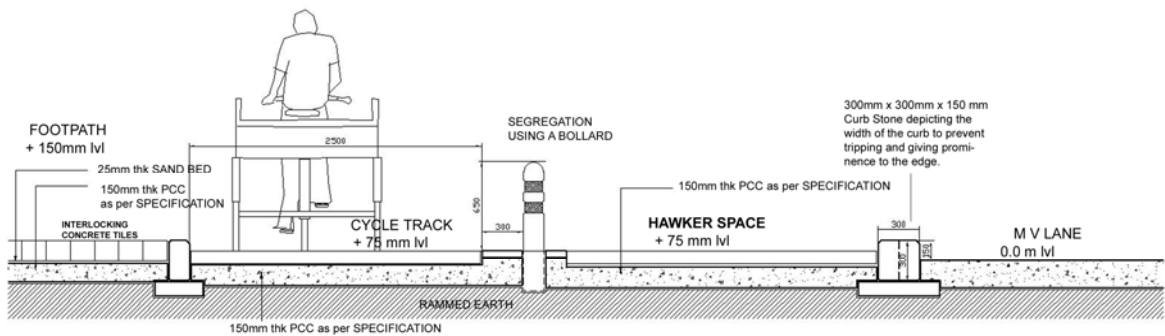


Figure 15: Detail section of hawker space between cycle track and MV lane

### 3. Proposed Sample Designs for Ambedkar Nagar to Delhi Gate Corridor

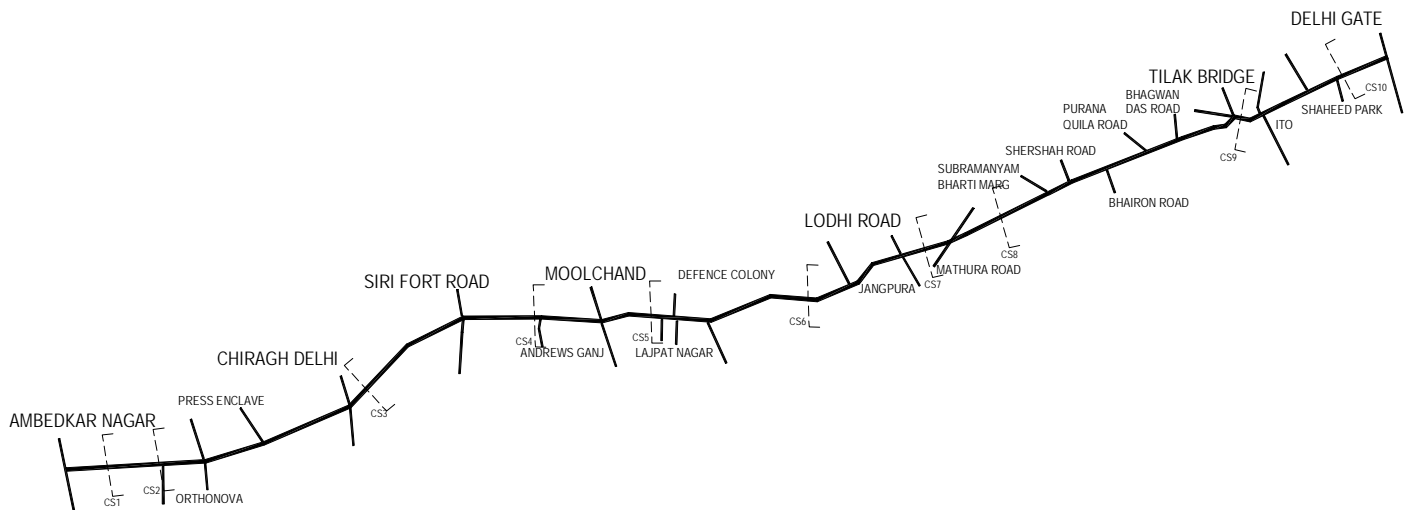
#### 3.1 Overview of Geometric Details of Ambedkar Nagar to Delhi Gate Corridor

The first corridor of BRT is 19 km long from Ambedkar Nagar to ISBT. The section from Ambedkar Nagar to Delhi Gate is 16.3 km long. Table 13 gives inventory of existing junctions, pedestrian subways and bus shelters on various sections of the corridor (Figure 16). **Space allocated for moving traffic has been increased by 1.5m throughout the corridor.**

**Table 13: Existing junctions, pedestrian subways and bus shelters on various sections of the corridor**

S. No.	Section	Length in km <sup>11</sup>	4 way junction <sup>11</sup>	T junction <sup>11</sup>	Ped. Subway <sup>11</sup>	Flyover <sup>11</sup>	Bus shelter <sup>11</sup> (both direction)
1	Ambedkar Nagar-Chiragh Delhi	2.9	1	3	-	-	12
2	Chiragh Delhi-Sirifort	1.5	1	-	1	1	3
3	Sirifort-Moolchand	1.4	1	1	1	1	6
4	Moolchand – Lodhi Road	3.2	1	-	1	1	9
5.	Lodhi Road – Tila Bridge	3.7	1	5	2	2	14
6.	Tilak Bridge – Delhi Gate	1.6	3	-	-	-	6

**Figure 16: Ambedkar Nagar to Delhi Gate Corridor-Schematic Plan**



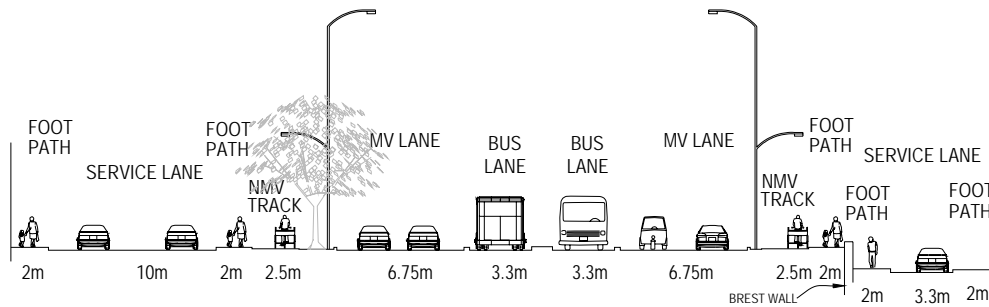
**Table 14: Existing and proposed cross sections**

S. No.	Section	Avg. R/W		MV +bus lanes (no.)		Service lane		NMV lane	
		Ext.	prp	Ext. <sup>12</sup>	prp	Ext. <sup>12</sup>	prp	Ext. <sup>12</sup>	prp <sup>13</sup>
1	Ambedkar Nagar-Chiragh Delhi	46	46	11 (3)	10.05 (3)	9.7	6.9	-	2.5
2	Chiragh Delhi-Sirifort	45.5	45.5	11 (3)	10.05 (3)	7.2	5.95	-	2.5
3	Sirifort-Moolchand	46	46	11 (3)	10.05 (3)	5.6	5.0	-	2.5
4	Moolchand – Lodhi Road	58.34	58.34	11 (3)	10.05 (3)	10.6	11.7	-	2.5
5	Lodhi Road – Tila Bridge	41.2	41.2	11 (3)	10.05 (3)	9.12	8.85	-	2.5
6	Tilak Bridge – Delhi Gate	51.6	51.6	11 (3)	10.05 (3)	16.8	15.9	-	2.5

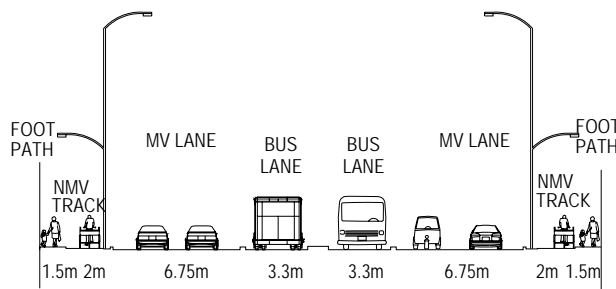
2 MV lanes for each direction traffic totaling 6.75m in width support motor vehicle traffic movement at upto 70 km/h.<sup>13</sup>

Dedicated bus lane width of 3.3m (for each direction) supports bus speeds of up to 50 km/h.<sup>4</sup>

**Figure 17: Proposed cross sections (facing Delhi Gate side) of Ambedkar Nagar to Delhi Gate BRT corridor (refer figure 16 for location of cross section ‘CS’ on plan).**



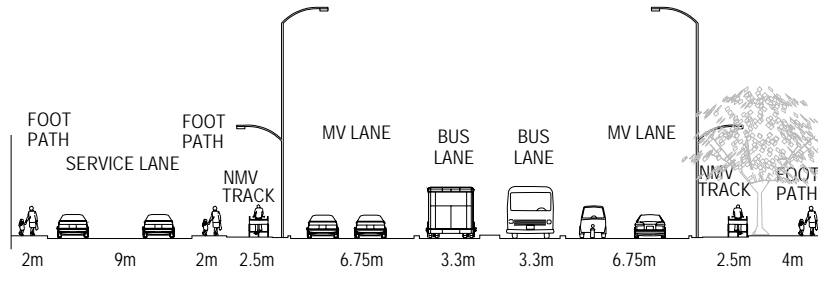
CS1 - Pushpa Vihar Quarters (Section 1) - Right of Way-51.5m



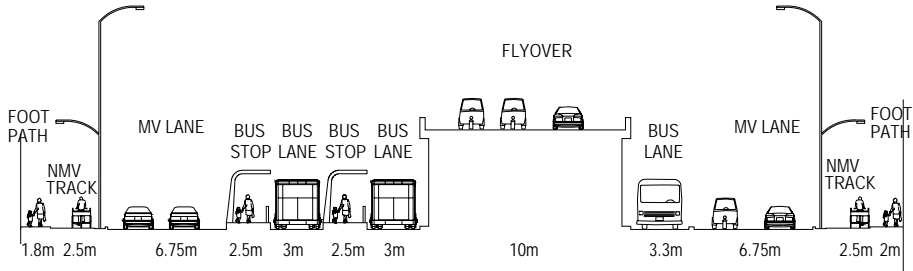
CS2 - Virat Marg Crossing (Section 1) - Right of Way-28m

<sup>12</sup> Mixed lanes, shared by Motor vehicles, buses and NMVs

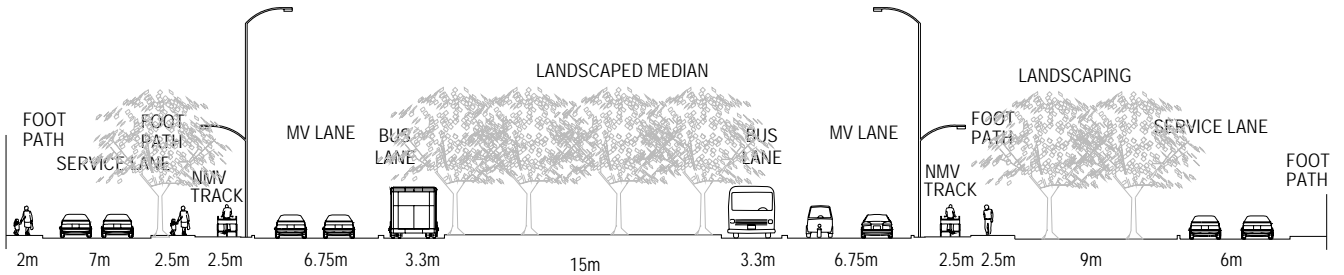
<sup>13</sup> C.R.O.W, ASVV, Recommendations for Traffic Provisions in Built-up Areas, The Netherlands



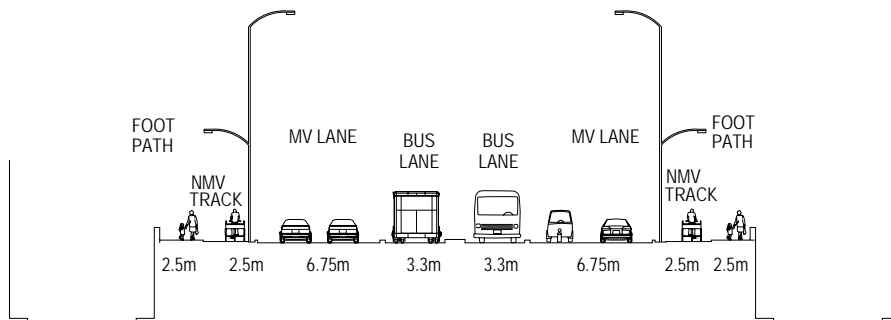
CS3 - Panchsheel Enclave (Section 2) - Right of Way-46m



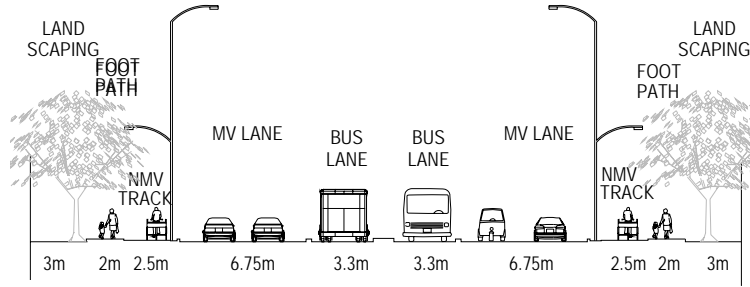
CS4 - Andrews Ganj Crossing (Section 3) - Right of Way-50.5m



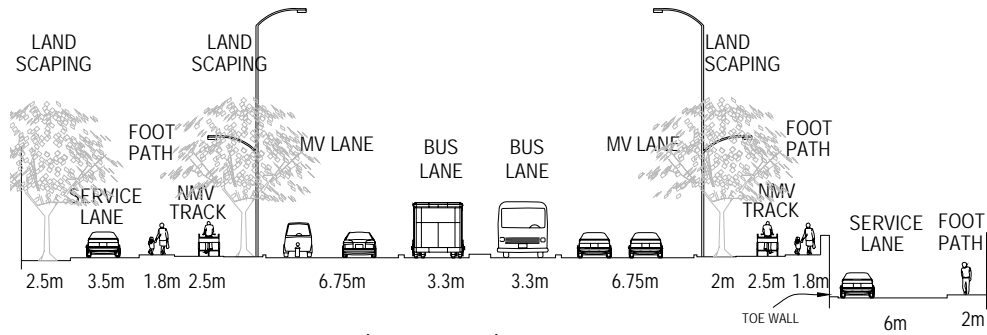
CS5 - Lajpat Nagar (Section 4) - Right of Way-72m



CS6 - Rail Over Bridge (Section 4) - Right of Way-33m

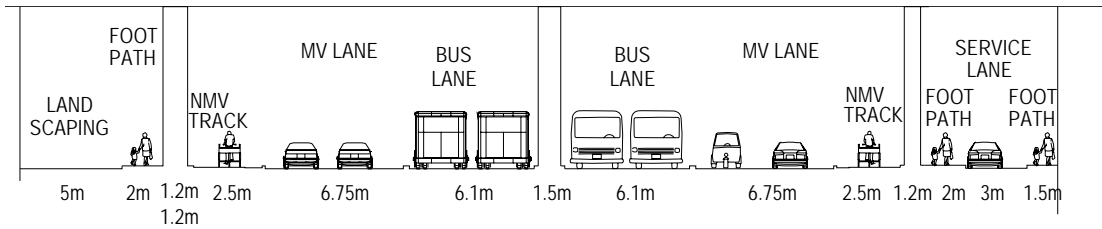


CS7 - Oberoi Hotel (Section 5) - Right of Way-36.5m

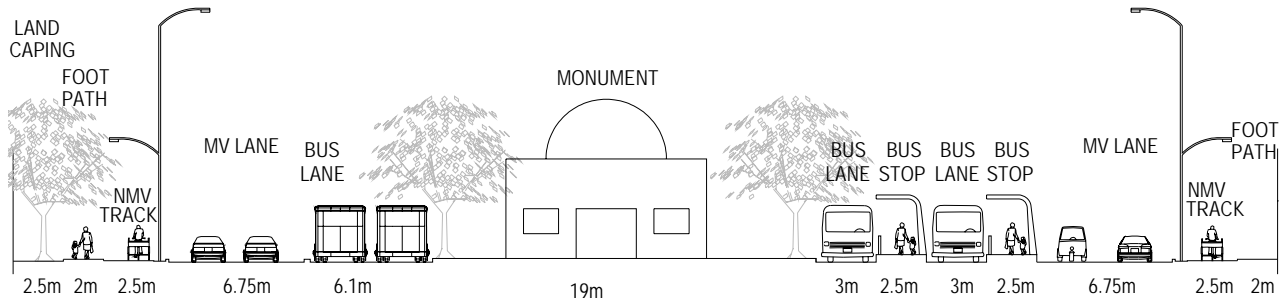


CS8 - Sunder Nagar (Section 5) - Right of Way-48m

RAILWAY BRIDGE



CS9 - Tilak Bridge (Section 6) - Right of Way-50.5m



CS10 - Maulana Azad Medical College (Section 6) - Right of Way-66m

### 3.1.1 Bus Shelters

Parallel bus shelters have been proposed at an average interval of 400 to 600m throughout the length of the corridor from Ambedkar Nagar to Delhi Gate (Figure 17 and Table 13). All the bus shelters are parallel (two for each direction) except at mid blocks and set of shelter for each direction are staggered by a minimum length of 50m. Each bus shelter is accessed through a safe signalized pedestrian crossing. Table 15 gives summary of proposed bus shelters (total for both direction traffic) on these sections:

**Table 15 summary of proposed bus shelters (parallel shelters)**

S. No.	Section	Junction shelters	Mid Block Shelters
1	Ambedkar Nagar-Chiragh Delhi	8	2
2.	Chiragh Delhi-Sirifort	2	2
3	Sirifort-Moolcnd	4	-
4	Moolchand – Lodhi Road	2	4
5	Lodhi Road – Tilak Bridge	9	1
6	Tilak Bridge – Delhi Gate	7	-

### 3.1.2 Bus Lanes

Continuous, physically segregated, dedicated, 3.3m wide continuous bus lanes for each direction, have been provided throughout the stretch from Ambedkar Nagar to Delhi Gate (Figure 17). These lanes are discontinued 150m before (on both sides) of the flyover to allow merging of buses and other vehicles. Bus lanes split into two 3m wide lanes (for each direction) at the bus shelters. Bus lanes have been physically segregated from each other by a 0.6 to 1.5m wide, 0.3m high median. The segregation of bus lanes and MV lanes on either sides is achieved through a continuous 0.6m wide, 0.15m high median.

### 3.1.3 MV lanes

2 continuous, motor vehicle (MV) lanes, total of 6.75m wide, have been provided (for each direction traffic) throughout the stretch from Ambedkar Nagar to Delhi Gate (Figure 17). A total of up to 3 motor vehicle lanes have been provided for 76m length at on side of all junctions.

### 3.1.4 NMV Lanes

2.5m wide NMV (cycle) lanes have been provided throughout the length of the proposed corridor from Ambedkar Nagar to Delhi Gate. These lanes have been segregated from the Motor Vehicle lanes by a 0.75m wide median/unpaved zone (Figure 17) on 75% of the length, more than 0.75m wide green belt/footpath on 20% of the length, 0.3m wide median on 4% of the length of the corridor. The NMV track has been combined with the pedestrian walkway (due to space constraint) to provide a 3m wide common path for less than 1% length of the corridor. All NMV tracks are accessed through a ramp with a minimum gradient of 1:12. Cyclists can use the free left turn at junctions whereas straight and right moving traffic will negotiate the junction at green signals with other vehicles. To allow for safe movement of cyclists at green light on junctions, cycle holding boxes have been demarcated 5 m ahead of the stop line on the carriageway.

### 3.1.5 Pedestrian Path

Continuous pedestrian path has been provided on both sides of the carriageway and on both side of the service (lane for each direction). The total width of pedestrian paths varies from 4 to 8 m throughout the length of the corridor (Figure 17).

Pedestrian paths have been designed with a minimum width of 1.65m without any obstructions such as trees and poles. All pedestrian facilities have been designed to be barrier free and are accessed through ramps with a minimum gradient of 1:12.

### 3.1.6 Service Lanes

4 to 8m wide, intermittent service lanes have been provided throughout the length of the corridor for parking, and access to side lanes and properties (Figure 17). The access to side lanes is through a speed table with a minimum ramp gradient of 1:12 from all sides.

## 3.2 Andrews Ganj Junction

Andrews Ganj junction is located approximately 5km from the start of the corridor at Ambedkar Nagar. A recent one way flyover constructed at this location by the Public Works Department (PWD), along with restriction on right turning traffic from Josip Broz Tito Marg, has made this junction signal free. The flyover has been constructed in continuation with an existing grade separator over the Moolchand intersection, with only 80m length available between the two for weaving. In the absence of any safe pedestrian crossing, the junction has become a risk for crossing pedestrians and bus commuters and an existing 'U' turn under the flyover adds to the chaos. The proposed BRT design for this intersection proposes the following:

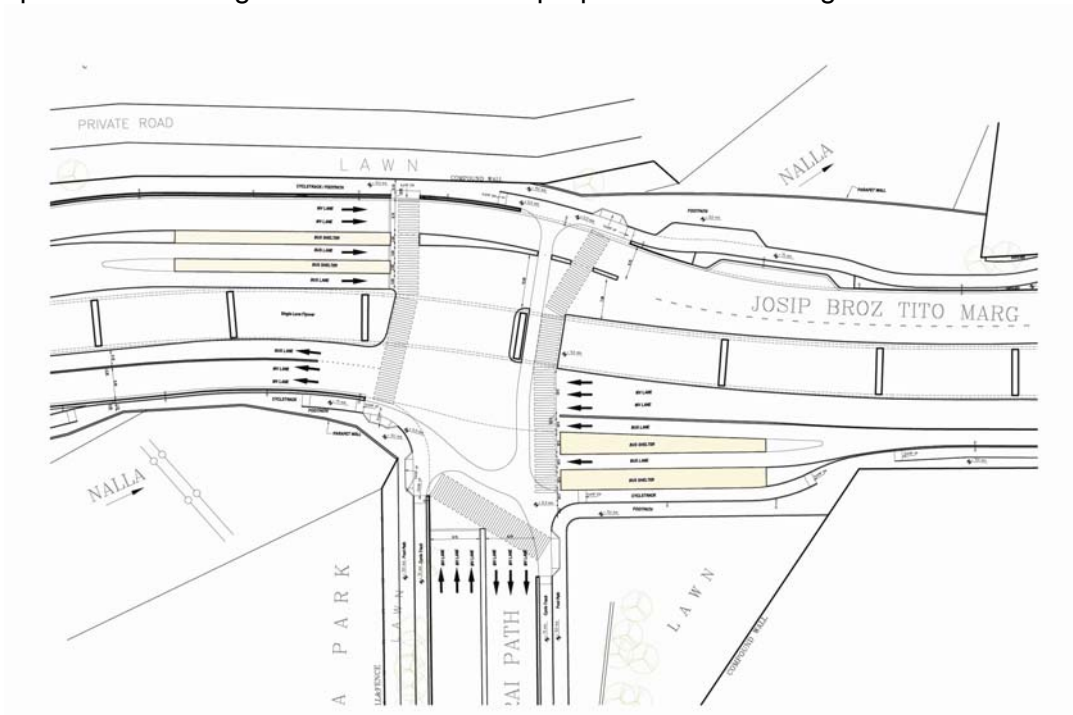
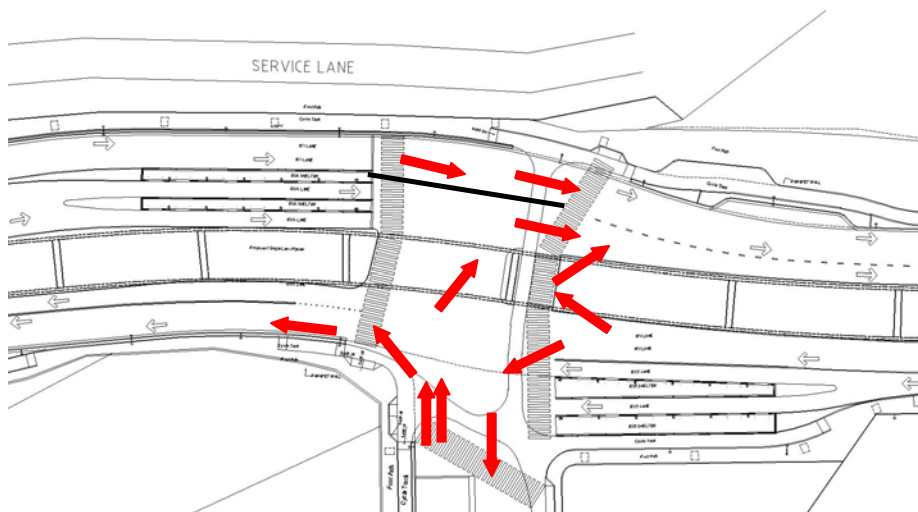


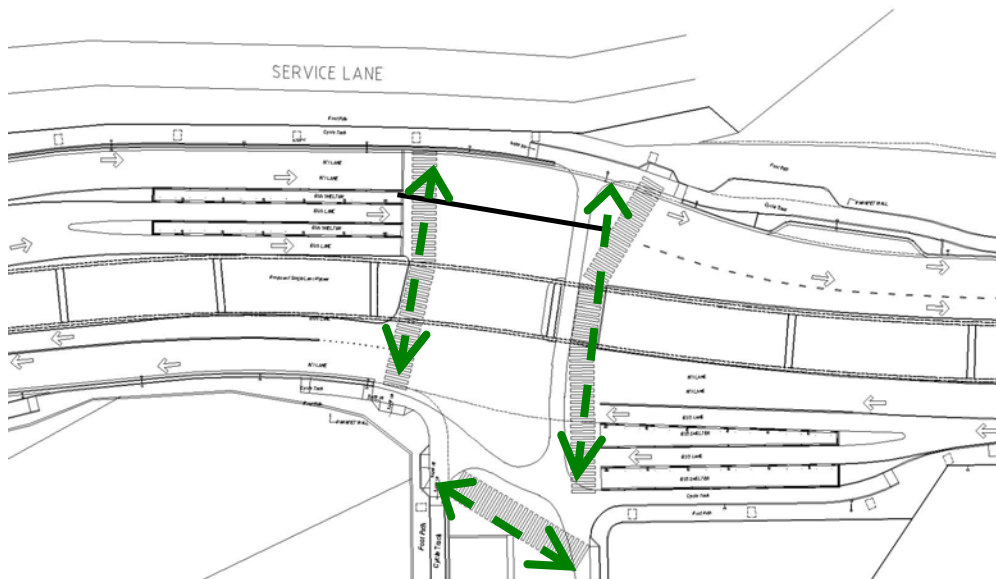
Figure 18: Proposed BRT design for Andrews Ganj Junction.

- 40 to 56m long parallel Bus shelters for each of direction traffic are proposed to be staggered on both sides of the junction. The bus shelter is proposed to be in central lane for bus traffic towards Delhi Gate and on the curb side lanes (segregated) for bus traffic towards Ambedkar Nagar (Figure 18).
- The existing restriction on right turning MV and Bus traffic is proposed to be maintained.
- Straight Movement of motor vehicles towards Moolchand can be given priority, with these vehicles stopping every 50 seconds for a 20 second pedestrian phase only. This compliments the current planning of traffic police and PWD, to allow for uninterrupted straight traffic at this junction.
- 'U' turn under the Andrews Ganj flyover when going towards Moolchand shall be closed and vehicles need to take the 'U' turn under Moolchand flyover.
- 'U' turn under the Andrews Ganj flyover when going towards Chiragh Delhi can remain signal free.
- Left turning Motor Vehicle from Josip Broz Tito Marg Towards Nehru Place, shall be signalized and combine with right turning green phase for motor vehicle from Nehru Place towards Moolchand.
- Free right turning Motor Vehicular traffic from Nehru Place towards Moolchand shall be signalized, and this signal shall be synchronized with the signal for GK I turning 50m before Andrews Ganj junction; to avoid stopping the vehicles twice in this short stretch.
- All traffic stops for 20 seconds after every 50 second green (Figures 19 to 22) to allow for pedestrian movement.
- Bus Lanes and Bus Shelters remain on the left on both sides of the Andrews Ganj junction on Josip Broz Tito Marg
- Free 'U' Turn under the Andrews Ganj flyover for both direction traffic can be given. However since the 'U' turn for traffic towards Moolchand is very close to the stop line, it will be rendered useless when straight moving motor vehicles on J B Tito Marg stop for right turning vehicle from Nehru Place.
- Straight moving buses towards Moolchand can enjoy almost continuous green, stopping every 50 seconds for a 20 second green for pedestrian crossing (Figure 19 to 22).

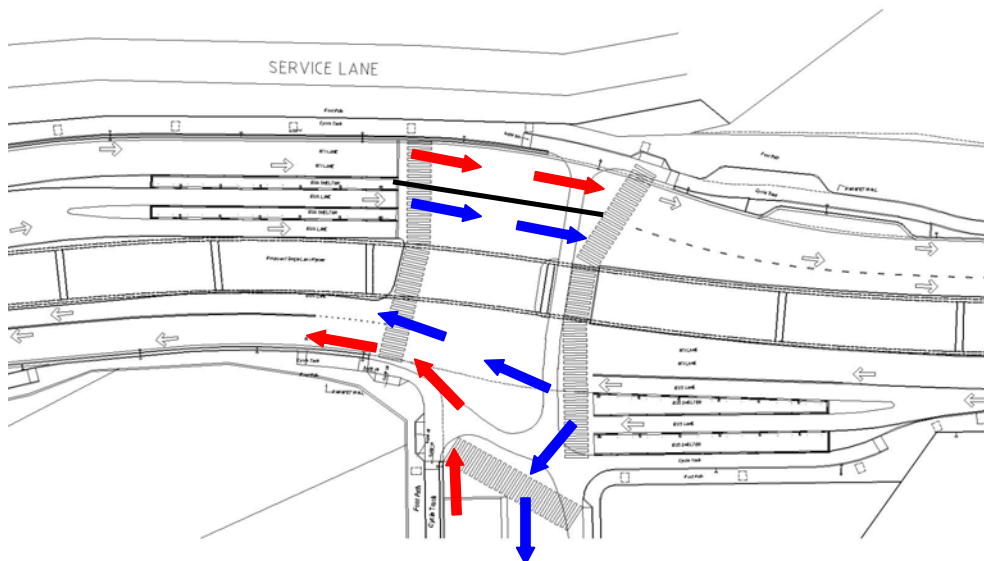


**Figure 19: Andrews Ganj intersection signal cycle; phase 1, length 55 second – MV movement in all direction.**

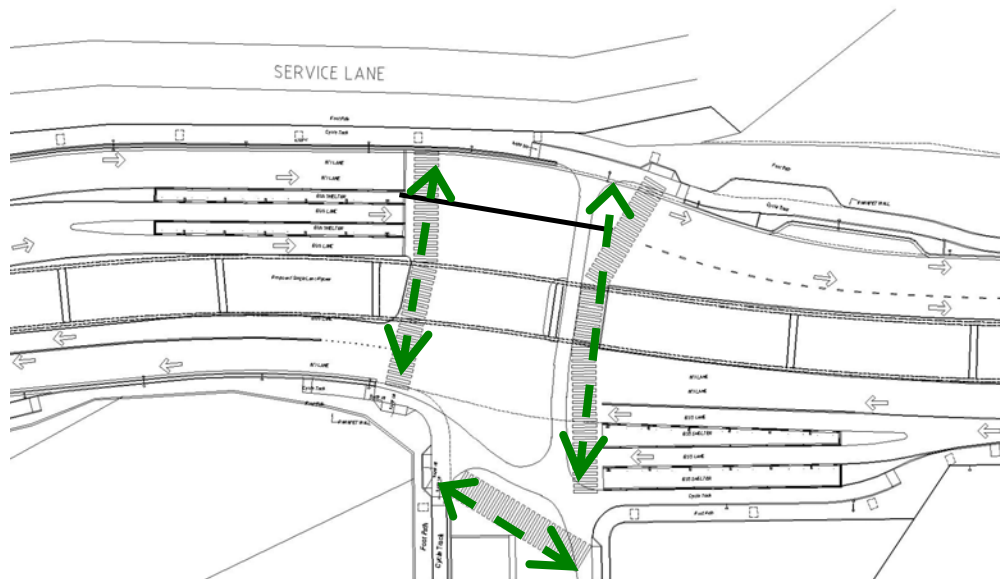




**Figure 20: Andrews Ganj intersection signal cycle; phase 2, length 20 second – Pedestrian movement in all directions.**



**Figure 21: Andrews Ganj intersection signal cycle; phase 3, length 55 second – MV and bus movement.**



**Figure 22 : Andrews Ganj intersection signal cycle; phase 4, length 20 second – Pedestrian movement for all directions.**

### 3.3 Moolchand Junction

Moolchand junction is located at the intersection of Josep Broz Tito Marg with Inner Ring Road. An existing flyover caters to the straight moving traffic on Josip Broz Tito Marg and a proposed underpass will serve the straight traffic on the inner ring road; leaving the road level for turning traffic only. As this junction caters to heavy traffic of commuters interchanging routes and direction of travel, it is proposed that bus shelters be provided at the junction on road level for turning buses and buses catering to route interchange traffic; on both Ring Road, and Josep Broz Tito Marg (Figure 23). Turning bus and motor vehicle traffic at this junction results in a high weaving movement at the foot of the flyover between buses and motor vehicles, going over or under the grade separator. The existing geometry of flyovers at Moolchand, Andrews Ganj and the proposed proposed underpass on Ring Road; and the respective location of bus shelters, results in conflicting movement of vehicles in the traffic streams. The existing (DTTDC proposed) location of bus shelters forces commuters to walk a minimum of 548m and a maximum of 1255m for interchanging between any two public transport streams. The proposed BRT designs with central bus lanes resolves some of the weaving and reduces the total number of vehicles involved in conflicting movements from 28574 PCUs (24308 motor vehicles and 1422 buses) to 27907 PCUs (26497 motor vehicles and 470 buses) (Table 16). The proposed BRT design provides for all bus shelters to be at the junction under

the flyover. This reduces the walking distance of commuters interchanging between routes to between 40 to 73m (Table 17).



**Figure 23: Proposed design for BRT at Moolchand intersection**

Table 16: Direction wise comparison of weaving lengths for cars and buses for existing bus system (bus shelter locations) and proposed BRT system (junction bus shelters)

	Conflicting movements of vehicles										No. of Vehicles	
	From	To	Existing System (including DTTDC proposal for MV under pass)				Proposed BRT Sytem (including DTTDC proposal for MV under pass)				Motor Vehicle	Buses
			Car Weaving Length (m)		Bus Weaving Length (m)		Car Weaving Length (m)		Bus Weaving Length (m)			
			Longit udinal	Trans verse	Longit udinal	Trans verse	Longit udinal	Trans verse	Longit udinal	Trans verse		
MOOLCHAND FLYOVER – JB TITO MARG	Lajpat Nagar	Over the Moolchand Flyover	-	-	138	9.8	150	10	-	-	5575	96
	Lajpat Nagar	Under the Moolchand Flyover	138	9.8	-	-	-	-	150	10	1990	25
	Over Mool;chand flyover	Lajpat Nagar	-	-	150	11.5	150	10	-	-	5726	108
	Under Moolchand Flyover	Lajpat Nagar	150	11.5	-	-	-	-	150	10	4521	32
MOOLCHAND AND ANDREWS GANJ FLYOVER	Under the Moolchand flyover (in front of college of nursing)	To Andrews Ganj Flyover towards Chiragh Delhi	140	11	140	11	140	10	-	-	1073	30
	Under the Moolchand flyover (in front of college of nursing)	Andrews Ganj junction towards Nehru Place (under the Andrews Ganj Flyover)	140	0	-	-	-	-	140	0	904	6

	Foot of Moolchand Flyover	Foot of Andrews Ganj Flyover (towards Chiragh Delhi)	-	-	140	0	-	-	-	-	2146	48
	Foot of Moolchand Flyover (from over the flyover)	Andrews Ganj 'T' Junction (under the flyover)	140	11	140	11	140	10	-	-	1808	24
ANDREWS GANJ FLYOVER - J B TITO MARG	Foot of Andrews Ganj Flyover (coming on the flyover)	Chiragh Delhi	-	-	38	11	150	10	-	-	3219	78
	Foot of Andrews Ganj Flyover (coming under the flyover)	Chiragh Delhi	38	11	-	-	-	-	150	10	281	2
J B TITO NARG - MOOLCHAND FLYOVER	Andrews Ganj 'T' junction (from Chiragh Delhi)	Over Moolchand Flyover	314	12	183	11.5	379	10	-	-	2425	18
	Andrews Ganj 'T' junction (from Chiragh Delhi)	Under Moolchand Flyover	-	-	-	-	-	-	379	10	2058	42
	Andrews Ganj 'T' junction (from Nehru Place)	Over Moolchand Flyover	-	-	133 + 183	11.5 + 11.5	-	-	-	-	1040	66

	Andrews Ganj 'T' junction (from Nehru Place)	Under Moolchand Flyover	318	12	133	11.5	-	-	379	10	882	69
DTTDC PROPOSED UNDERPASS FOR MVs ON RING ROAD	South Extension	Ashram at the foot of the vehicular underpass	-	-	280	11.5	150	10	-	-	1890	230
	South Extension	J B Tito Marg by the side of the underpass	280	11.5	-	-	-	-	150	10	3445	182
	South Extension, from the underpass	Ashram	-	-	282	11.5	-	-	-	-	1890	230
	J B Tito Marg, by the side of the underpass	Ashram	282	11.5	-	-	-	-	-	-	1663	241
	Ashram	South Extension through the vehicular under pass	-	-	282	11.5	150	10	-	-	2658	214
	Ashram	J B Tito Marg, by the side of the underpass	282	11.5	-	-	-	-	150	10	4144	33
	Vehicular under pass on ring road	South Extension	-	-	280	11.5	150	10	-	-	2658	214
	J B Tito Marg	South Extension, by the side of the Vehicular under pass	280	11.5	-	-	-	-	150	10	2054	130

Table 17: Comparison of walking distances for interchanging pedestrians between public transport streams for existing and proposed (BRT) geometric design and location of bus shelters

Origin and Destination Streams		Distance in m (Existing Sytem)	Distance in m (BRT System)
Ring Road (Ashram Side)	Lala Lajpat Rai Path (for Nehru Place)	1234 m	58m
Ring Road (South Extension Side)	Lala Lajpat Rai Path (For Nehru Place)	1266 m	69m
Ring Road (Ashram Side)	J B Tito Marg (Lajpat Nagar Side)	984m	73m
Ring Road (South Extension Side)	J B Tito Marg (Lajpat Nagar Side)	830m	69m
Ring Road (Ashram Side)	J B Tito Marg (Sadiq Nagar Side)	977m	58m
Ring Road (South Extension Side)	J B Tito Marg (Sadiq Nagar Side)	805m	69m
J B Tito Marg (Sadiq Nagar Side)	Lala Lajpat Rai Path (for Nehru Place) – Before Andrews Ganj Crossing	596m	50m
J B Tito Marg (Sadiq Nagar Side)	Lala Lajpat Rai Path (For Nehru Place) – After Andrews Ganj Crossing	548m	40m

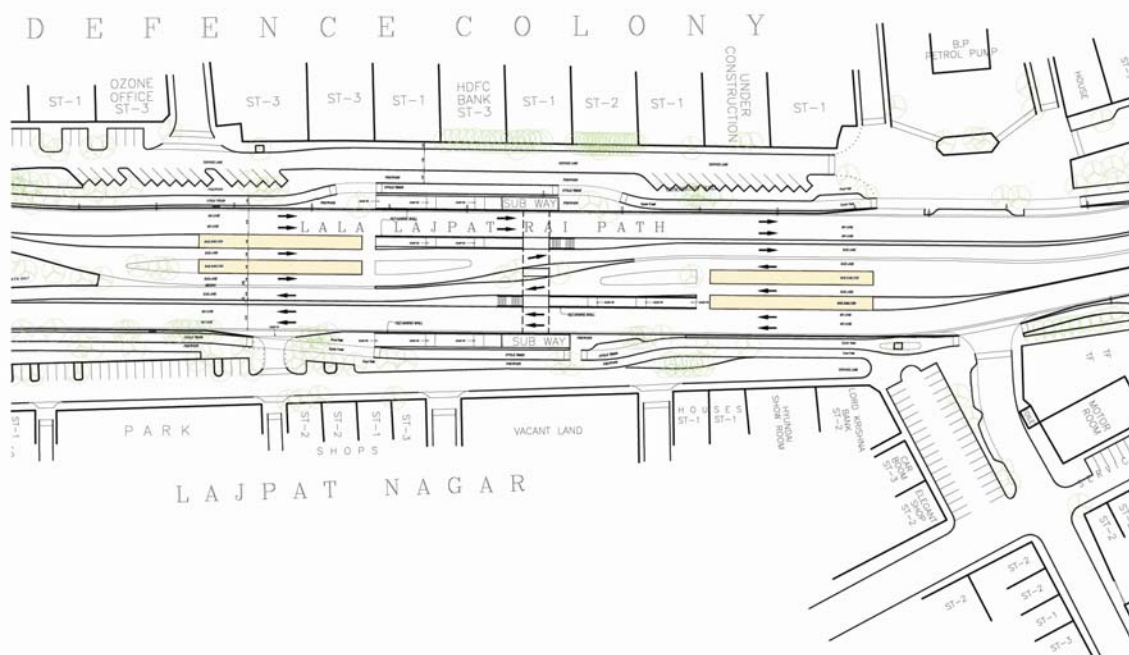
The following design details are proposed for BRT at this location:

- 40 to 56m long parallel bus shelters are proposed in central bus lanes on all arms of the intersection.
- Extra turning pockets are proposed to be created on all arms of the intersection for left turning motor vehicular traffic. Thus the total width of MV lanes on all arms is proposed to be 12.75m on the 'on side' of the junction.
- Priority will be given to U turning MV traffic from Ambedkar Nagar (as right turning at Andrews Ganj junction is restricted). Dedicated U turning lane is proposed to be created between flyover columns on the 'on side' of the junction.

### 3.3 Defense Colony Pedestrian Subway

Lajpat Nagar market (opposite Defense Colony Residential area) is one of the most active and crowded markets in Delhi. The market attracts lot of commuter traffic and is located along a collector street at a distance of 500m from the Moolchand junction, and is roughly mid-way between the Moolchand flyover and the Defense Colony Rail over bridge. An existing subway is located 150m before the defense Colony Rail Over-bridge. A bus shelter for the BRT is proposed at this location to serve both Lajpat Nagar and Defense Colony. The existing pedestrian subway is proposed to be modified and ramps added to make it barrier free for all and also to connect it to the bus shelters in the central lane (Figure 24). The key design features are as following:

- 44m long parallel bus shelters (with a total capacity of 6 buses) for each direction of traffic have been located on both sides of the pedestrian underpass.
- The existing subway entrance and the retaining walls are proposed to be structurally modified, to include access, by ramps to bus shelter platforms and the side pedestrian paths.
- The ramps are 2.5m wide and designed at a slope of 1:20. 2.5m wide landings have been provided after every 10m length of the ramp to maintain its accessibility by wheelchairs.
- Tactile flooring is proposed to be provided throughout the pedestrian facility to make it accessible by visually challenged commuters.



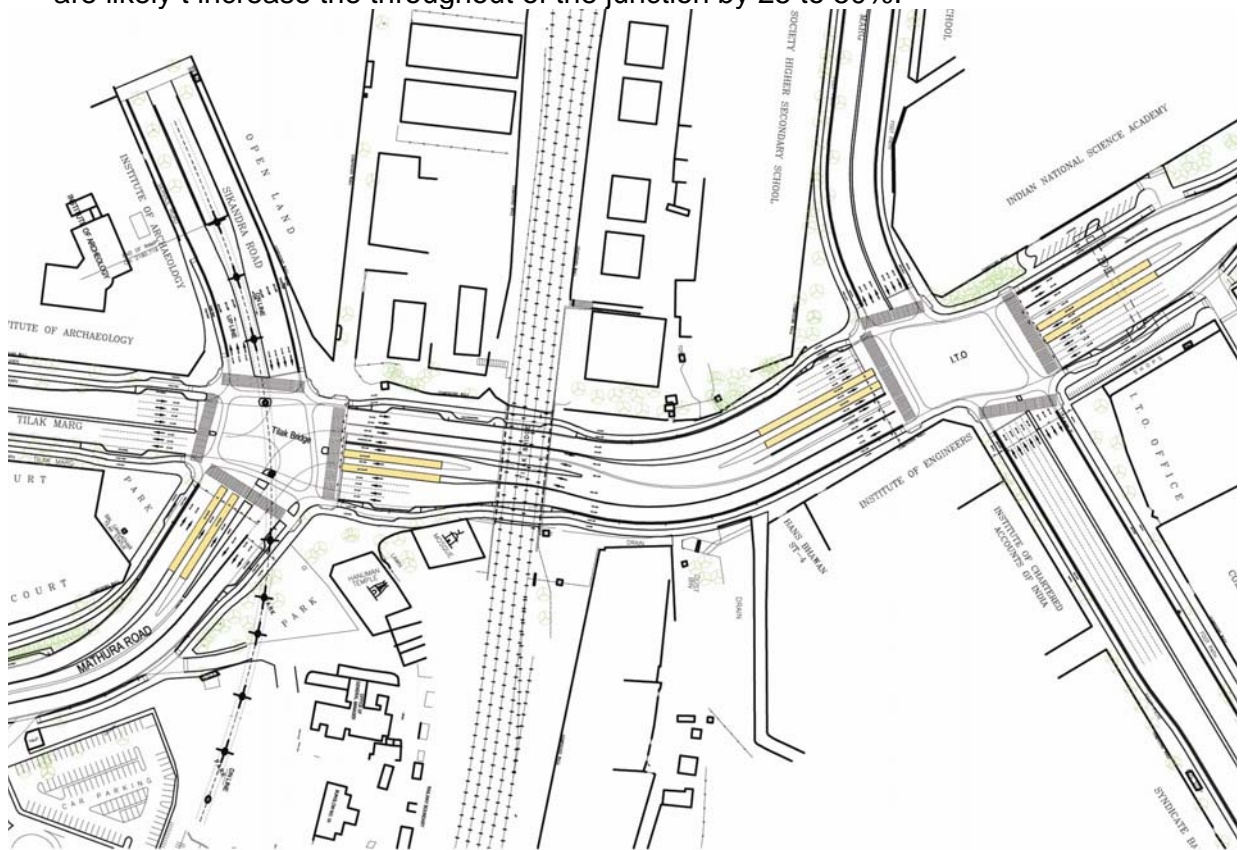
**Figure 24: Proposed design for BRT at Defense colony underpass and mid-block bus shelter**



### 3.4 Tilak Bridge and ITO crossing

Tilak Bridge and ITO crossing are spaced at a distance of 250m from each other on the northern edge of the proposed BRT corridor from Ambedkar Nagar to Moolchand. These intersections handle the maximum peak hour bus traffic on the corridor which exceeds 400 buses per hour per direction (including chartered and school buses).<sup>14</sup> Two traffic streams; that is one from West/Central Delhi to Trans Yamuna, and the other from South Delhi to North Delhi, lead to such heavy pedestrian and vehicular demand at these locations. The following design details are proposed to cater to peak vehicular and pedestrian demand at these locations (Figure 25):

- 56m long parallel bus shelters have been provided for each direction at Tilak Bridge and ITO junctions.
- Since the distance between bus shelters at these junctions is relatively small, bus routes (for each direction) are proposed to be divided between them.
- Bus shelters at on side of Tilak Bridge junction (for traffic heading towards Ambedkar Nagar) and at on side of ITO junction (for traffic heading towards Delhi Gate ) have been provided with a 3.3m wide overtaking lane for buses turning right. This will provide an additional capacity of up to 240 buses and would cater to routes served at the previous bus shelter.
- A total of 4 MV lanes (totaling 12.75m) are proposed to be provided on the 'on side' of both junctions (for traffic in each direction). These extra turning pockets are likely to increase the throughput of the junction by 25 to 50%.



**Figure 25: Proposed design for BRT at Tilak Bridge and ITO intersection**

<sup>14</sup> RITES, Feasibility Study, High Capacity Bus System, Ambedkar Nagar to ISBT Corridor, 2002

## 4. Signalization Plans

Traffic signalization plan has been worked out for the junctions on the proposed BRT corridor. The existing traffic volumes, modal shares, accident data and bus route as well commuter data have been analyzed to work out the proposed signal cycle and phasing sequence. Analysis has also been conducted to do an impact assessment of the proposed geometric and signal designs on the existing traffic safety and efficiency.

### 4.1 Existing Traffic

#### 4.1.1 Traffic Volume

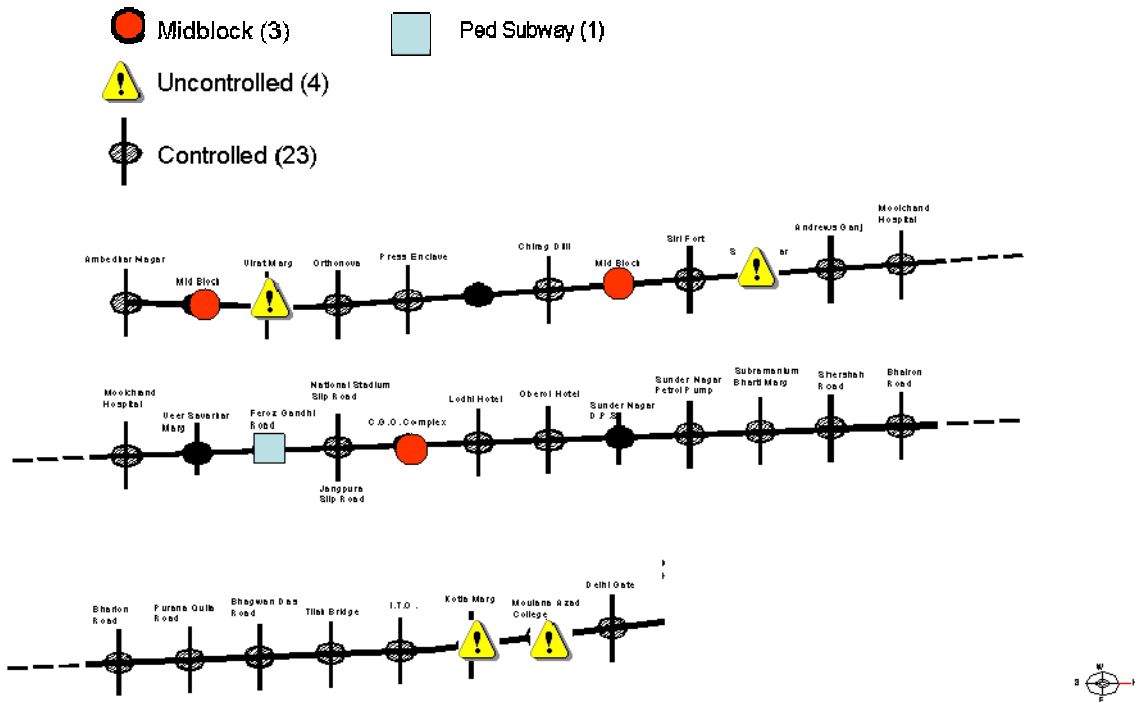
Existing traffic data has been studied and the details of traffic numbers at junction with maximum peak hour traffic volumes along with modal split (at ITO junction) has been shown in table 18.

Table 18: Traffic volume and Modal split at ITO Junction

S.No.	Vehicle Type	Total No.	Modal Share (%)
1	Two wheeler	4981	29.96
2	Three Auto	2554	15.36
3	CR_Cars	6854	41.22
4	Cycle	597	3.59
5	Cycle Rickshaw	17	0.10
6	LCV	22	0.13
7	Truck	7	0.04
8	ALL BUS	1593	9.58
9	TOTAL	16628	100

### 4.2 Junctions

The total number of existing signalized junctions on the corridor is 23. Currently bus shelters are not located close to the junctions and there exists no provision for safe crossing of commuters accessing the bus shelters. In the proposed design the number of signalized junctions is maintained at 23. A total no. of 26 bus shelter locations is proposed on this corridor. Out of these 23 are proposed to be located at existing junction, and mid block bus shelters along with two phase signalized pedestrian crossing is proposed at 3 locations. Figure 26 shows location of controlled and uncontrolled junctions along with location of proposed pedestrian signals at mid block bus shelters.



**Figure 26: Line diagram of the corridor representing location and type of junction**

### 4.3 Bus Routes

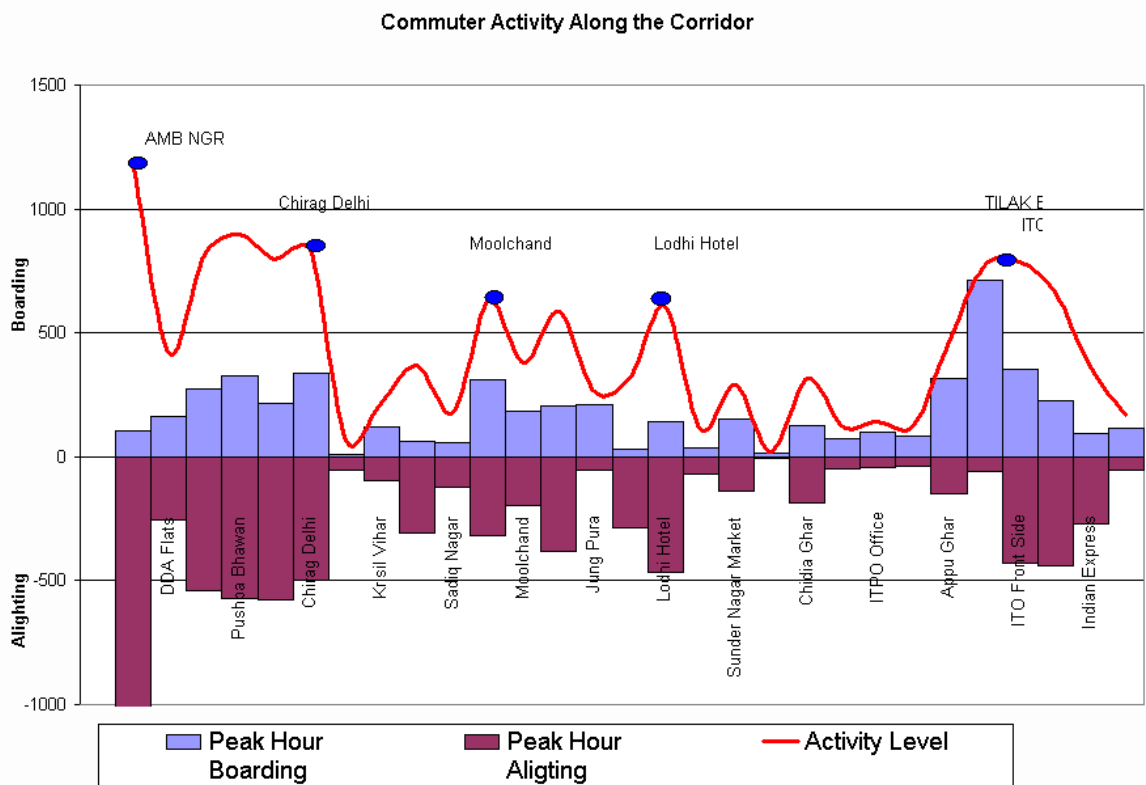
The total number of bus routes on the first proposed BRT corridor from Ambedkar Nagar to Delhi Gate is 84. In the first phase of the project all of these routes will use the proposed system. The details of these routes and their overlap on the corridor has been shown in figure 27.



## 4.4 Bus Commuters

Existing bus commuter demand has been analysed from data collected from all existing bus shelters on the BRT corridor from Ambedkar Nagar to Moolchand. The analysis shown in figure 28 shows that the maximum commuter activity along the corridor is observed at Ambedkar Nagar. The total no. of commuters boarding and alighting at this location is more than 1200 people per hour (for peak direction). Other bus shelter location with higher commuter activity are; Chiragh Delhi, Moolchand, Lodhi Road Crossing and Tilak Bridge Crossing.

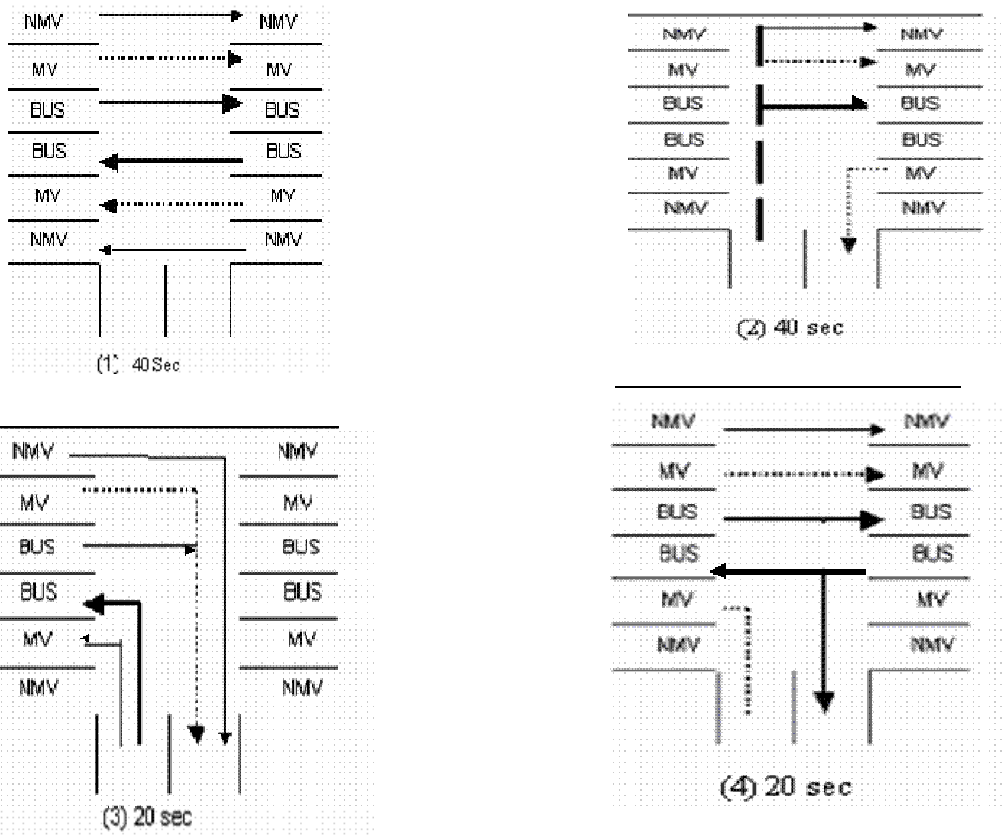
**Figure 28: Existing commuter activity along the proposed BRT corridor from Ambedkar Nagar to Delhi Gate.**



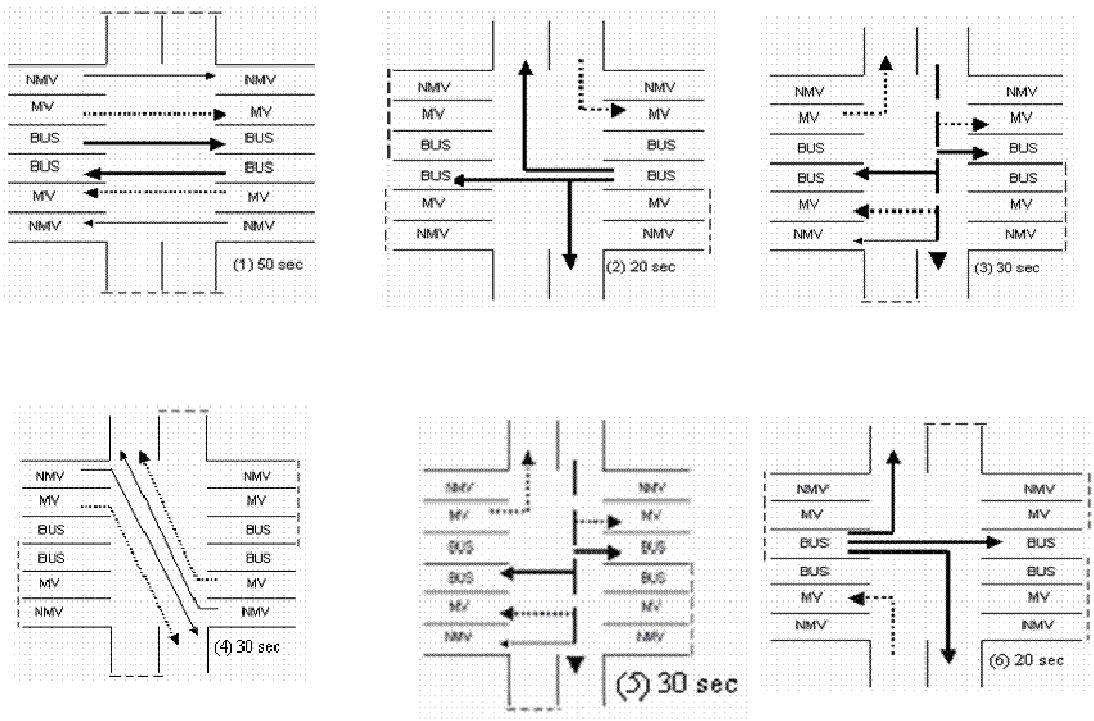
## 4.5 Proposed Signalization Plans

Proposed signalization plans for the first BRT corridor have been developed specific for each junction. The signalization plans have been modeled for existing traffic demand (for each junction) and vehicular delays, queue lengths and average speeds analyzed (refer section 4.6 of this report). Figure 29 and 30 show typical signal phasing diagram for 3 and 4 armed junctions with dedicated signal phase for buses and their order within the cycle to provide safe pedestrian green phases without causing delay to either pedestrians or motor vehicles.

**Figure 29: Typical signal phase diagram for a 3 armed junction on the proposed BRT corridor**



**Figure 30: Typical signal phase diagram for a 4 armed junction on the proposed BRT corridor**

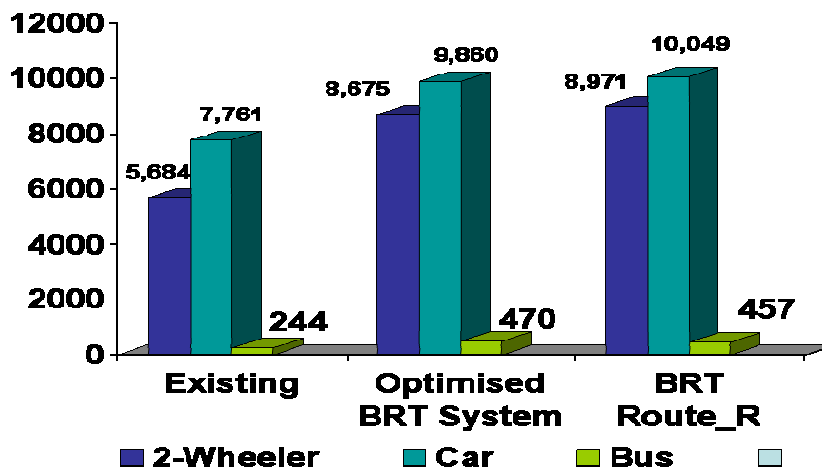


## 4.6 Impacts

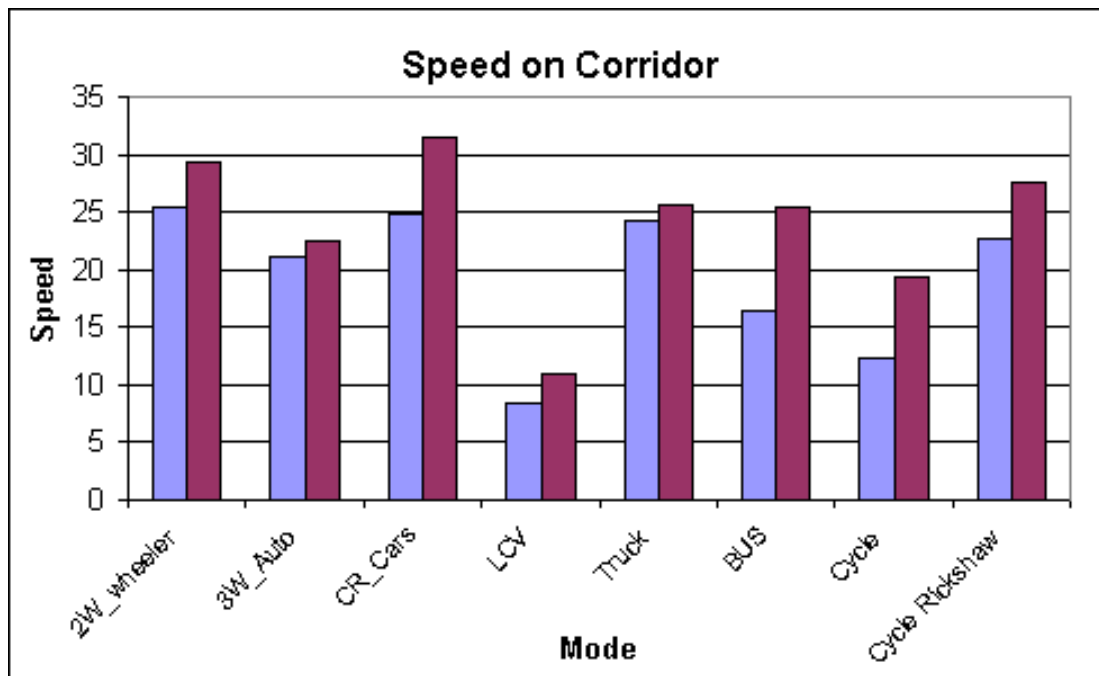
### 4.6.1 Traffic Volume and Speed

Microscopic simulation on AIMSUN, with the designed geometry and signal system for the proposed BRT corridor shows a significant improvement in vehicle capacities and speed for both an optimized BRT system and BRT system without route rationalization. Figure 31 and 32 the comparative improvement in corridor capacity and speed for existing corridor and corridor with BRT system.

**Figure 31: Comparative improvement in corridor capacity for existing, optimized BRT and BRT with route rationalization.**



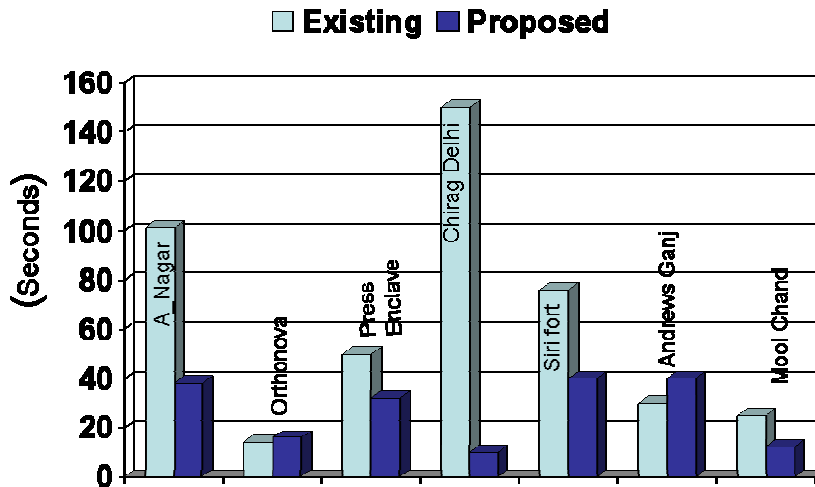
**Figure 32: Comparative improvement average speeds for existing corridor (column 1) and the proposed BRT corridor (column 2).**



#### 4.6.2 Pedestrian Delays

The signal designs for the proposed BRT corridor reduces delays for crossing pedestrians at signalized intersections to less than 60 seconds. This contributes significantly in reducing risk of pedestrian fatalities as research shows that most pedestrians do not honor controlled crossings when the delay is more than 60 seconds. Figure 33 shows the comparative pedestrian delays on seven junctions on the proposed BRT corridor.

**Figure 33: Comparative pedestrian delays on seven junctions on the proposed BRT corridor.**

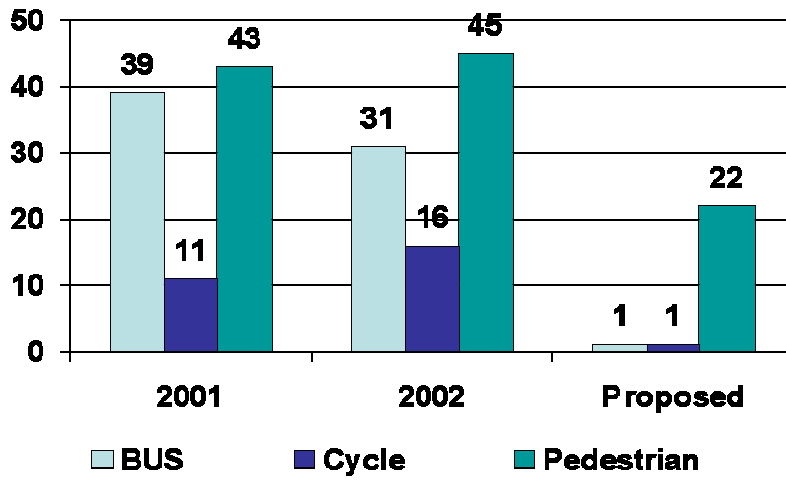


#### 4.6.3 Safety

Accident data from 2001 and 2002, traffic police reports show that the number of fatalities for pedestrians and cyclists on the proposed BRT corridor from Ambedkar Nagar to Delhi Gate, are increasing with the increased motorization. Analysis of proposed geometric and signal designs for the BRT system show that significant reduction in conflicts between vulnerable road users and motor vehicles is being achieved. This will lead to a substantial reduction in fatalities on the corridor. Figure 34 shows the expected reduction in fatalities of bus commuters, cyclists and pedestrians.

**Figure 34: Expected reduction in fatalities of bus commuters, cyclists and pedestrians.**





## **ANNEXURE I**

### **Summary of Discussions with the Stakeholders**

### Chronological Summary of Meetings with Client

<b>S. No.</b>	<b><u>Date</u></b>	<b><u>Chaired By</u></b>	<b><u>Decisions</u></b>
1	16.01.2003	Chief Secretary, GNCTD	<ol style="list-style-type: none"> <li>1. Project recommended for implementation</li> <li>2. Work Plan and rationale for corridor selection be placed before Chief Minister and the Council of Ministers for approval</li> </ol>
2	27.01.2003	Chief Minister, GNCTD	<ol style="list-style-type: none"> <li>1. Project by the consortium of RITES/TRIPP to start work immediately on all 7 corridors</li> <li>2. Appointment of PMC by inviting EOI from desirous parties after completion of detailed survey by consortium in six weeks</li> <li>3. Detailed survey and implementation of pilot corridor to be completed by RITES in 4 months.</li> <li>4. Urban bus manufacturers may be approached to ascertain whether 30 buses within order placed by DTC could be arranged to run on pilot corridor(s) within 6 months</li> </ol>
3	05.02.2003	Commissioner Transport, GNCTD	<ol style="list-style-type: none"> <li>1. Pre-Feasibility Report to be submitted in 6 weeks shall include details about land acquisition, encroachments to be removed, trees affected and utilities to be diverted</li> </ol>
4	25.02.2003	GM, ISBT, GNCTD	<ol style="list-style-type: none"> <li>1. GAD for 2 priority corridors to be completed by 15<sup>th</sup> March</li> <li>2. HCBS corridor will continue along Netaji Subhash Marg from Delhi Gate till ISBT and not rerouted via Ring Road.</li> <li>3. C.Sect-Hari Nagar corridor to be altered - Hari Nagar Depot to Clock Tower segment replaced by Hari Nagar to tilak Nagar segment</li> <li>4. IDFC would prepare details of financing options</li> </ol>
5	18.03.2003	Chief Secretary, GNCTD	<ol style="list-style-type: none"> <li>1. Design parameters approved</li> </ol>

<b>S. No.</b>	<b><u>Date</u></b>	<b><u>Chaired By</u></b>	<b><u>Decisions</u></b>
6	26.03.2203	Commissioner, MCD	<ol style="list-style-type: none"> <li>1. HCBS corridor form Ambedkar Nagar to ISBT found suitable for immediate development in 3 phases               <ol style="list-style-type: none"> <li>A) A. N. Terminal to Moolchand (priority section to be completed by October 2003)</li> <li>B) Moolchand to ITO</li> <li>C) ITO to ISBT</li> </ol> </li> <li>2. The revised alignment suggested by RITES of ETB corridor from C. Sect to Tilak Nagar is better than earlier one – but 2 overbridges and 4 land owning agencies may create problems of coordination. Therefore it should be taken up as the second priority corridor.</li> <li>3. A utility group to be set up to determine the shifting of utilities.</li> <li>4. SPV should be set up immediately to start implementing the project, possibly under STA.</li> </ol>
7	29.04.2003	Chief Secretary, GNCTD	<ol style="list-style-type: none"> <li>1. PWD should vet cost estimates of RITES</li> <li>2. If RITES is willing, it can be made PMC</li> <li>3. Time and cost estimates to be reaffirmed</li> <li>4. Traffic Police to be consulted while finalising traffic arrangements/modifications</li> </ol>
8	10.05.2003	DCP, DTP	<p>Workshop for Engineers/ Official of MCD</p> <ol style="list-style-type: none"> <li>1. Traffic Diversion Scheme found suitable</li> </ol>
9	16.06.2003	Commissioner Transport, GNCTD	<ol style="list-style-type: none"> <li>1. EFC memo finalisation</li> </ol>
10	01.07.2003	Transport Minister, GNCTD	<ol style="list-style-type: none"> <li>1. EFC approval to be expedited</li> <li>2. Appointment of RITES as PMC to be formalised</li> <li>3. A utilities committee on the DMRC pattern to be constituted within a week</li> <li>4. Detailed designs to be mutually agreed by RITES and IIT</li> <li>5. PWD approval to be taken for its portion of the corridor</li> <li>6. Initiate competition for bus shelter design</li> <li>7. Decision for placing orders with bus manufacturers to be taken immediately</li> </ol>
11	17.07.2003	Commissioner, MCD	<p>Workshop for Engineers/ Official of MCD</p>

<b>S. No.</b>	<b><u>Date</u></b>	<b><u>Chaired By</u></b>	<b><u>Decisions</u></b>
			1. Doubts raised about Design Parameters and Lane Capacities
12	01.08.2003	Finance Minister, GNCTD	1. Breakup of cost estimates sought 2. EFC approval deferred by 2 weeks
13	19.08.2003	Transport Minister, GNCTD	1. Breakup of cost estimates, including shifting of utilities, sought 2. EFC approval to be arranged within a week of getting details
14	21.08.2003	Commissioner, MCD	1. Utility agencies to provide details about affected utilities as soon as possible for the priority section.
15	03.01.2004	Commissioner Transport, GNCTD	1. Progress Review of the Project after formation of new state government in December 2003. 2. Implementation of priority corridor to be expedited
16	10.02.2004	Commissioner Transport, GNCTD	1. RITES told to go ahead with the study for all 7 HCBS/ ETB Corridors i.e. the study for 5 corridors of Phase-II can also be taken up now. 2. RITES' PMC fee for pilot corridor would be restricted to 7 %.
17	.04.2005	Fianance Minister, GNCTD	1. Cost & Financial Implications of the Ambedkar Nagar – Moolchand Pilot Corridor to be reviewed
18	27.04.2004	Commissioner Transport, GNCTD	1. MOU for the study formally agreed upon and finalised for signing. 2. PWD asked to verify the design and implementability on site for the Ambedkar Nagar – Moolchand Pilot Corridor
19	28.05.2004	Commissioner Transport, GNCTD	1. Meeting of utility agencies to be convened for implementability on site for the Ambedkar Nagar – Moolchand Pilot Corridor
20	22.06.2004	Commissioner Transport, GNCTD	1. PWD presented observations about the design
21	07.07.2004	Commissioner Transport, GNCTD	1. PWD gives formal approval in principle of the design for the pilot corridor after site visit and examination of the proposed design 2. Utility agencies told to provide their inputs to RITES positively by 23.07.2004
22	05.08.2004	Commissioner Transport, GNCTD	1. Discussion on SPV for the Pilot Corridor
23	13.08.2004	Principal Secretary (Finance),	1. Financial approval by EFC for Implementation of the Pilot Corridor at an

<b>S. No.</b>	<b><u>Date</u></b>	<b><u>Chaired By</u></b>	<b><u>Decisions</u></b>
		GNCTD	Estimated Cost of Rs 32.89 crore
24	23.08.2004	Commissioner Transport, GNCTD	1. Discussion on Implementation of the Pilot Corridor after financial approval
25	.09.2004	Additional Commissioner Transport, GNCTD	1. Discussion on Implementation of the Pilot Corridor after financial approval
26	.09.2004	DCP Traffic, Delhi Police	1. Delhi police would need their doubts about signalisation and traffic diversions to be clarified through detailed presentation
27	28.01.2005	E-in-C, PWD	1. Impact of upcoming underpass at Moolchand to be incorporated in the design of the pilot corridor
28	04.03.2005	Commissioner Transport, GNCTD	1. Discussion on overlapping of Mass Transit Corridors Pilot Corridor after financial approval
29	10.03.2005	Chief Secretary, GNCTD	1. Minor overlaps of HCBS & MRTS corridors allowed 2. Traffic Police and DTTDC to clarify their remaining doubts with TRIPP, IIT and RITES after meeting & site visit
30	11.03.2005	Minister (Transport & Power), GNCTD	1. Traffic Police and DTTDC to clarify their remaining doubts with TRIPP, IIT and RITES after site visit
31	18.03.2005	Joint Commissioner Transport, GNCTD	1. Traffic Police and DTTDC largely agree to the proposed design 2. Proposal should be vetted by DDA Technical Committee also
32	20.04.2005	Vice-Chairman, DDA	1. DDA experts largely agree with the design 2. Proposal to be formally put up to DDA Technical Committee for final approval